

## Chapter # 4

# AN INTRODUCTION TO GRAPHIC DESIGN

Graphic design is the process of visual communication, presenting the solutions for any visual complication or problem through the use of photography, illustration and typography. A graphic designer combines and creates images, text or symbols to communicate a message or idea. He creates a visual composition by using visual arts, typography and page layout for communication. Commonly the use of this field can be seen in the making of logos and branding (corporate design), making of books, magazines and newspapers (editorial design), poster making (advertising), web designing, environmental design, signage and products packaging etc.

### 4.1 Calligraphy, the Art of Lettering

The script of a language that is comprehensible to a target public becomes an important tool of visual communication. For labels of different products, posters, postal stamps, book covers or any form of branding a designer requires skill, aesthetics and creative approach to the art of lettering and typography. Designer's sense of creativity and artistic use of lettering (Calligraphy) creates an aesthetic appeal and powerful visual communication. Calligraphic letters may be based or drawn on writing but most significantly they represent the content in a unique way.

### 4.2 Urdu Calligraphy

Commonly in Pakistan for writing of Urdu, *Nastalique* script is considered as a standard style. This script is widely used for Urdu language in India and Pakistan.

“This script is defined by well-formed rules passed down through generations of calligraphers. The Urdu alphabet is derived from the Arabic script which itself is derived from the Aramaic script. In South Asia however, Urdu language is written in two different scripts: *Devnagri* and Arabic. In the parts of India, Urdu language has come under the influence of Hindi, borrowing its vocabulary as well as writing style from regional languages especially Sanskrit. However, in Pakistan, Urdu has retained its Persio-Arabic influence and is written in *Nastalique* script. *Nastalique* is also derived from two other styles of Arabic script *Naskh* and *Taleeq*. It was therefore named *Naskh-Taleeq* which gradually shortened to *Nastalique*.”<sup>2</sup>

### Tools and Material for Nastalique Calligraphy

1. **Qalam:** The foundation practice of this script requires a very sharp edge nib with right-oblique for broad and narrow strokes, up and down or sideways. Traditionally the pen is called Qalam, usually made of bamboo.

<sup>2</sup>S. Hussain, S. Rahman, A. Wali, A. Gulzar, and S. J. Rahman. "Grammatical analysis of Nastalique writing style of Urdu." Center for Research in Urdu language processing, FAST-nu, Lahore, Pakistan (2002).

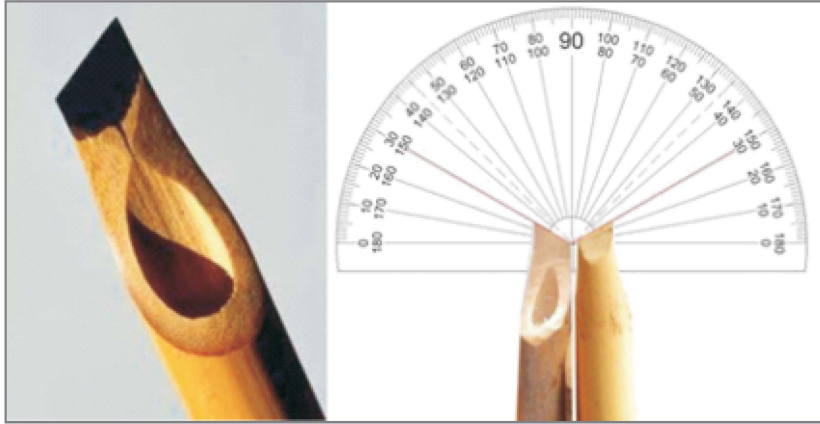

Figure 4.1 Bamboo Qalam for calligraphy and the angle of its nib

1. **Ink:** Calligraphers from the Mughal era in the subcontinent usually used homemade black ink prepared by mixing lamp-soot with water and gums. It was called *Mustafai Roshnai* after the name of its inventor Mustafa.

Now a day, various international inks are available in the market, which are imported from Middle East, Turkey and North America.

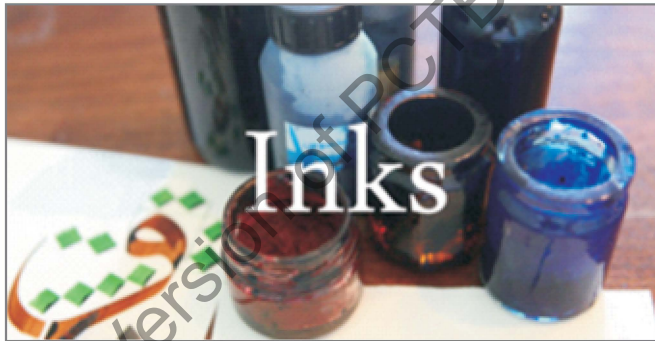

Figure 4.2

2. **Paper:** For the practice of calligraphy, traditionally a smooth silky paper is considered ideal because it allows the practitioner a fluent handling of qalam and ink.

Usually three types of paper are used for calligraphy: standard white glazed paper, handmade and dyed paper, Indian Ahar paper.



Figure 4.3 Paper for Calligraphy

## Urdu Calligraphy Practice # 1

### Practice of Urdu Alphabets

#### Material

1. *Qalam*
2. Ink
3. Calligraphy Paper (preferably printed with four lines)

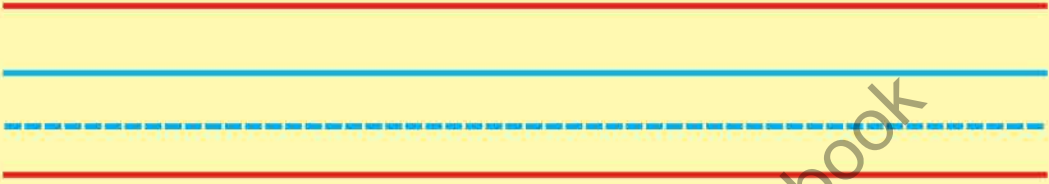

Figure 4.4 Example of Four lines for the practice according to the rules

**Note:** The students will practice a complete set of Urdu Alphabets according to the rules of *Nastalique* Script given below on the four-line paper.



Figure 4.5 Nastalique Script Alphabets

## Urdu Calligraphy Practice # 2

### The Anatomy of letter Alif in *Nastalique*

#### Material

1. *Qalam*
2. Paper
3. Ink

**Note:** Follow the instructions given in the diagram to learn the complete anatomy of the letter *Alif* in *Nastalique* script.

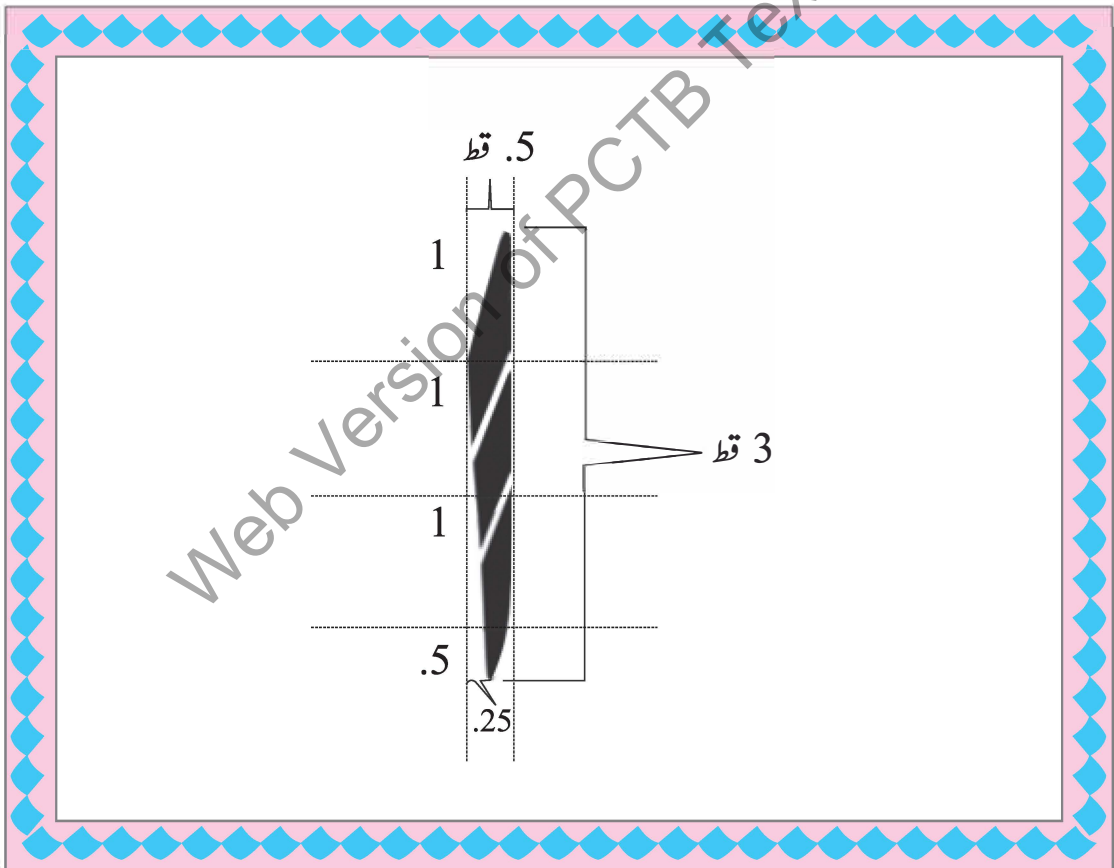

## Urdu Calligraphy Practice # 3

### The Anatomy of letter *Mad* in *Nastalique*

#### Material

1. *Qalam*
2. Paper
3. Ink

**Note:** Follow the instructions given in the diagram to learn the complete anatomy of the letter *Mad* in *Nastalique* script.

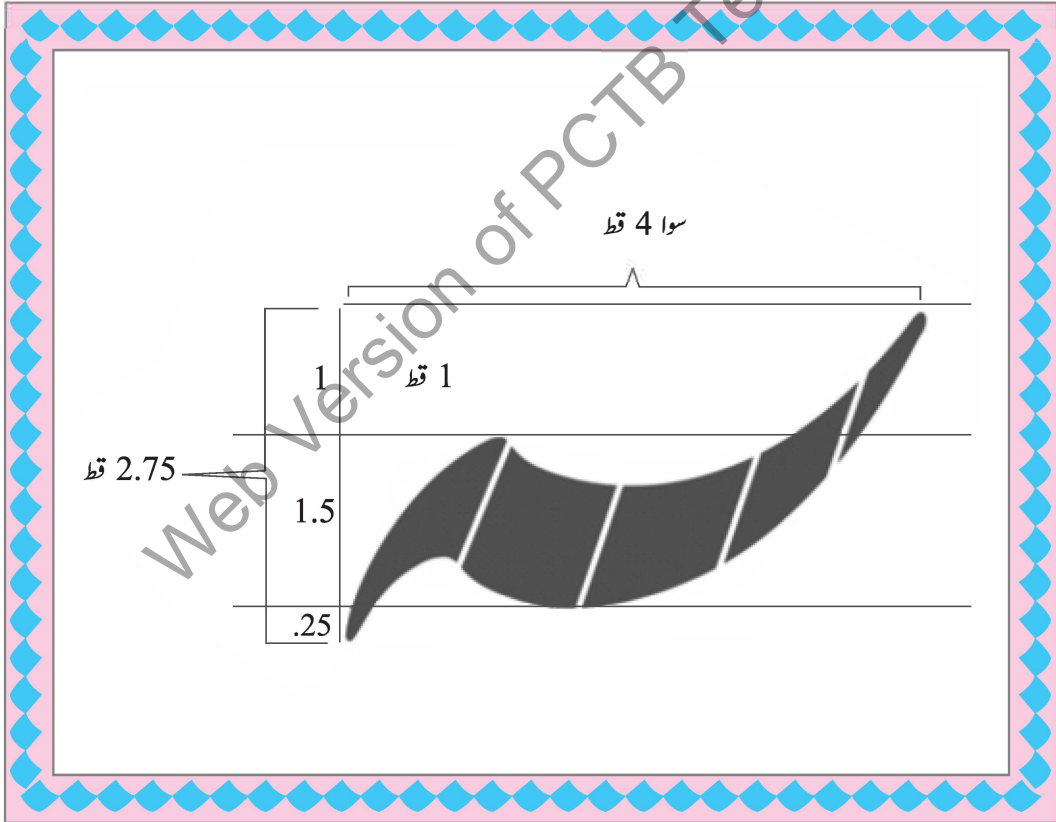

## Urdu Calligraphy Practice # 4

### The Anatomy of letter *Bay* in *Nastalique*

**Material** Note: Follow the instructions given in the diagram to learn the complete anatomy of the letter *Bay* in *Nastalique* script.

1. *Qalam*
2. Paper
3. Ink

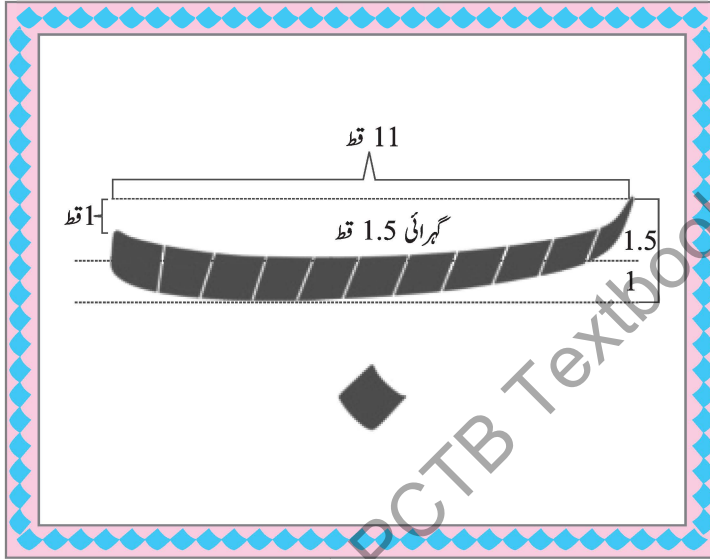

## Urdu Calligraphy Practice #5

### The Anatomy of letter *Tay* in *Nastalique*

**Material** Note: Follow the instructions given in the diagram to learn the complete anatomy of the letter *Tay* in *Nastalique* script.

1. *Qalam*
2. Paper
3. Ink

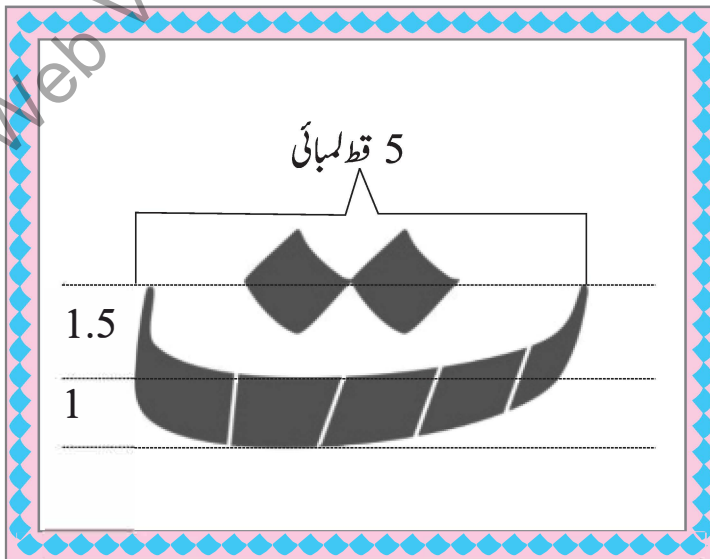

## Urdu Calligraphy Practice # 6

### The Anatomy of letter *Jeem* in *Nastalique*

#### Material

1. *Qalam*
2. Paper
3. Ink

Note: Follow the instructions given in the instructions given in the diagram to learn the complete anatomy of the letter *Jeem* in *Nastalique* script.

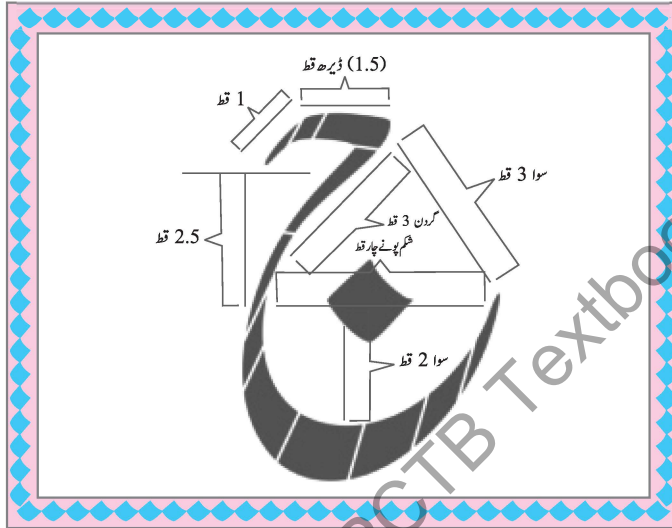

## Urdu Calligraphy Practice #7

### The Anatomy of letter *Daal* in *Nastalique*

#### Material

1. *Qalam*
2. Paper
3. Ink

Note: Follow the instructions given in the diagram to learn the complete anatomy of the letter *Daal* in *Nastalique* script.

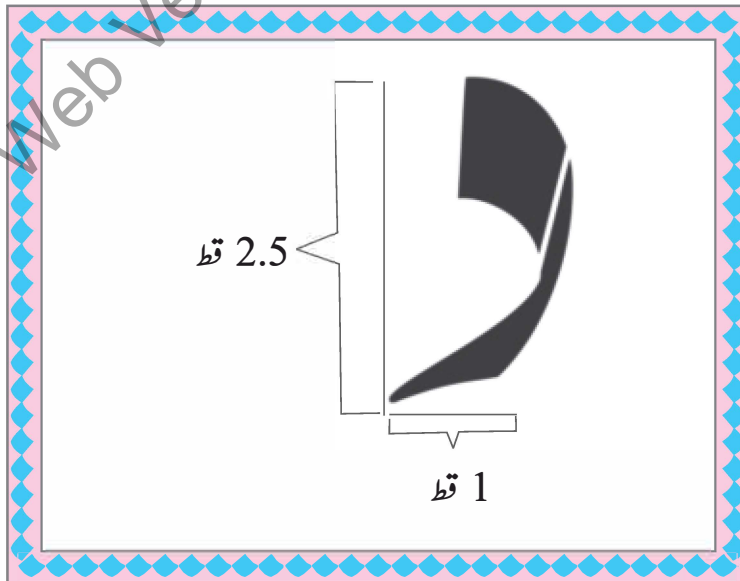

## Urdu Calligraphy Practice # 8

### The Anatomy of letter *Ray* in *Nastalique*

**Material** Note: Follow the instructions given in the diagram to learn the complete anatomy of the letter *Ray* in *Nastalique* script.

1. *Qalam*
2. Paper
3. Ink

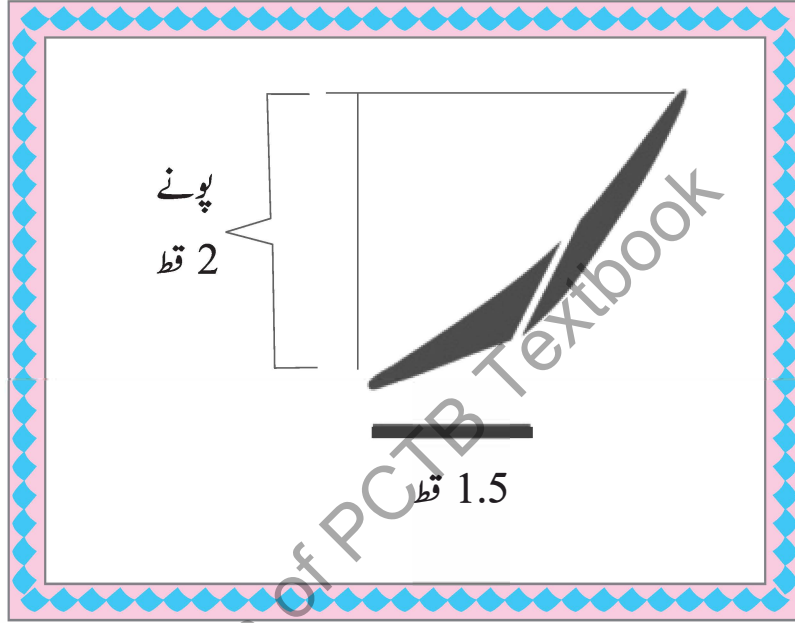

*Ray 1*

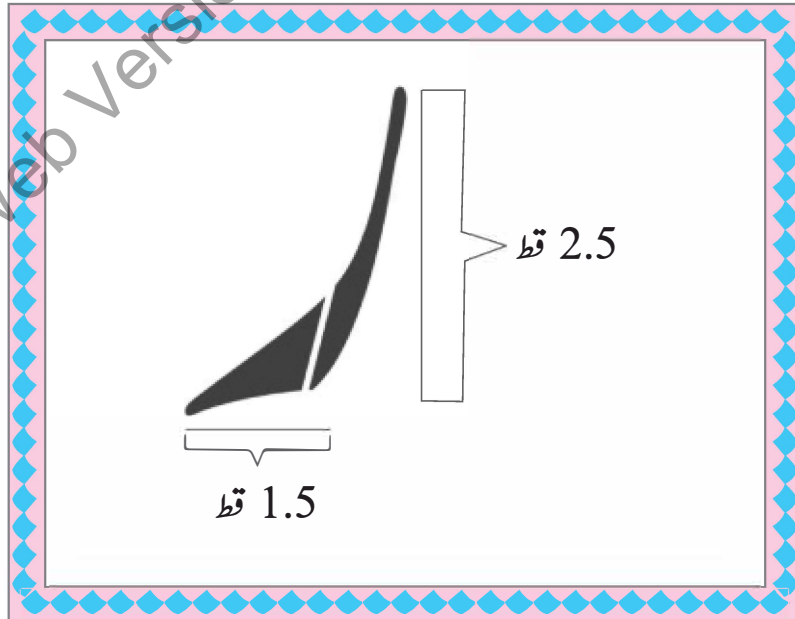

*Ray 2*



## Urdu Calligraphy Practice # 9

### The Anatomy of letter *Seenin Nastalique*

**Material** Note: Follow the instructions given in the diagram to learn the complete anatomy of the letter *Seen* in *Nastalique* script.

1. *Qalam*
2. Paper
3. Ink

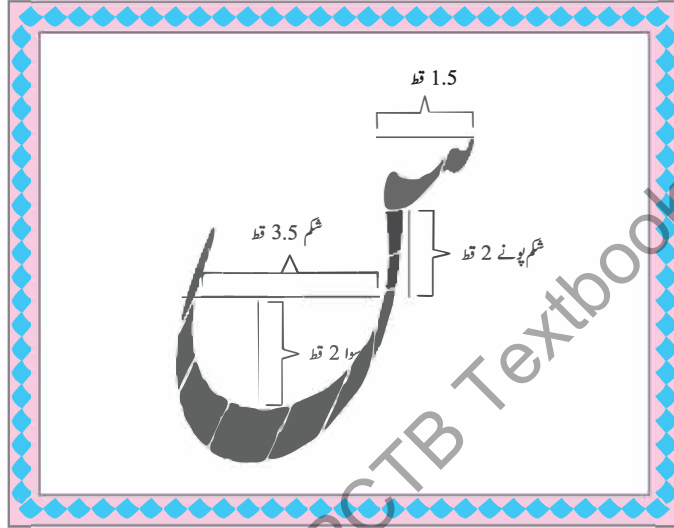

## Urdu Calligraphy Practice #10

### The Anatomy of letter *Sheen* in *Nastalique*

**Material** Note: Follow the instructions given in the diagram to learn the complete anatomy of the letter *Sheen* in *Nastalique* script.

1. *Qalam*
2. Paper
3. Ink

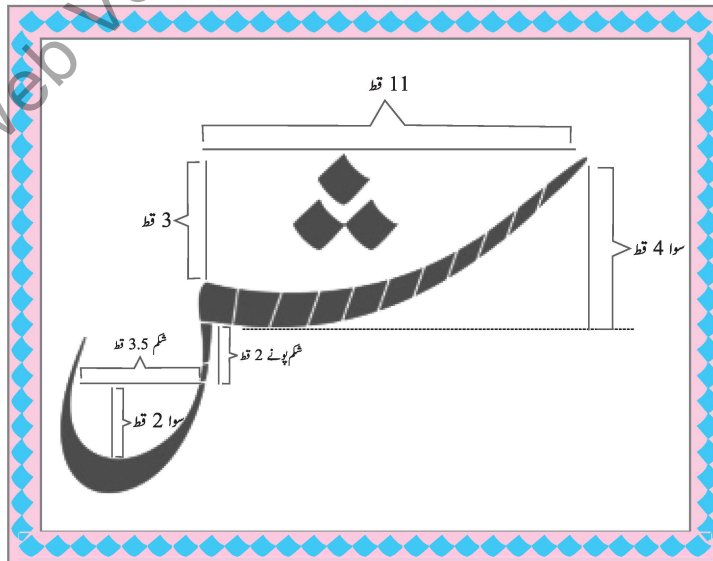

## Urdu Calligraphy Practice # 11

### The Anatomy of letter *Suad* in *Nastalique*

#### Material

1. *Qalam*
2. Paper
3. Ink

Note: Follow the instructions given in the diagram to learn the complete anatomy of the letter *Suad* in *Nastalique* script.

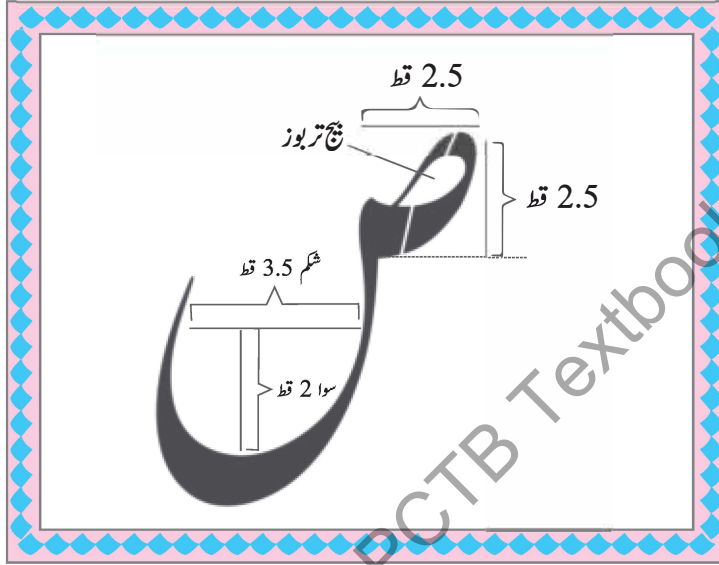

## Urdu Calligraphy Practice #12

### The Anatomy of letter *Toa* in *Nastalique*

#### Material

1. *Qalam*
2. Paper
3. Ink

Note: Follow the instructions given in the diagram to learn the complete anatomy of the letter *Toa* in *Nastalique* script.

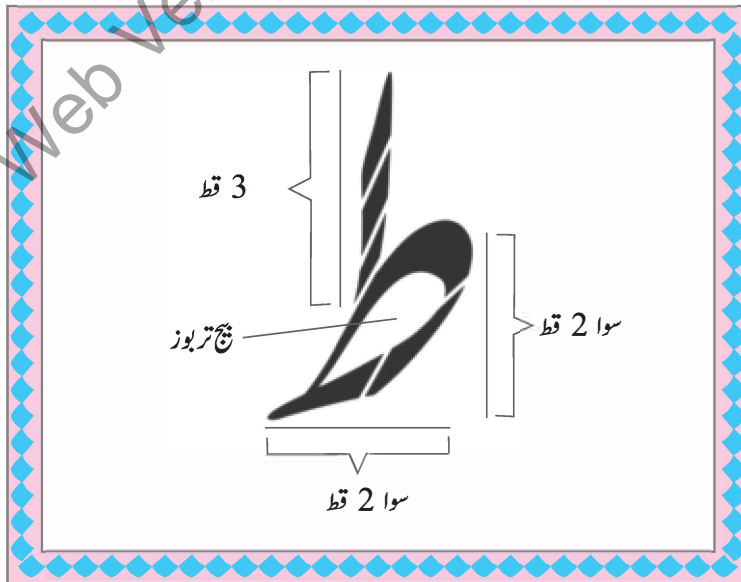

## Urdu Calligraphy Practice # 13

### The Anatomy of letter *Ain* in *Nastalique*

#### Material

1. *Qalam*
2. Paper
3. Ink

Note: Follow the instructions given in the *diagram* to learn the complete anatomy of the letter *Ain* in *Nastalique* script.

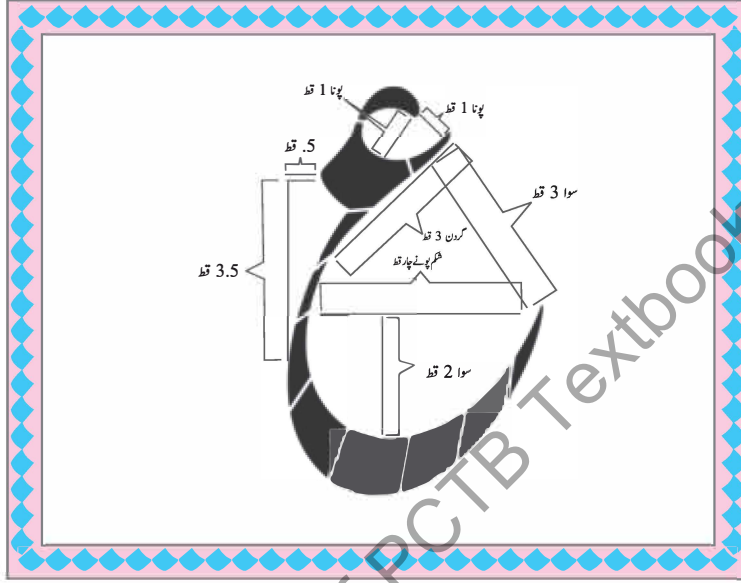

## Urdu Calligraphy Practice #14

### The Anatomy of letter *Fay* in *Nastalique*

#### Material

1. *Qalam*
2. Paper
3. Ink

Note: Follow the instructions given in the *diagram* to learn the complete anatomy of the letter *Fay* in *Nastalique* script.

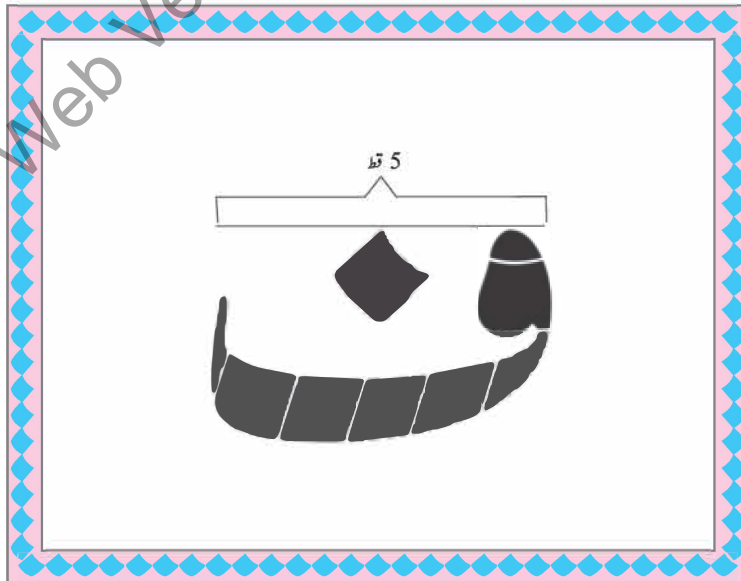

## Urdu Calligraphy Practice # 15

### The Anatomy of letter *Qaf* in *Nastalique*

#### Material

1. *Qalam*
2. Paper
3. Ink

Note: Follow the instructions given in the diagram to learn the complete anatomy of the letter *Qaf* in *Nastalique* script.

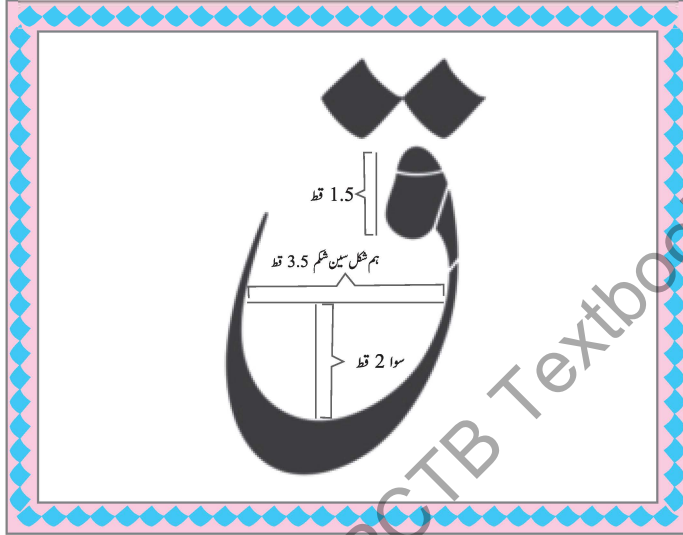

## Urdu Calligraphy Practice #16

### The Anatomy of letter *Kaf* in *Nastalique*

#### Material

1. *Qalam*
2. Paper
3. Ink

Note: Follow the instructions given in the diagram to learn the complete anatomy of the letter *Kaf* in *Nastalique* script.

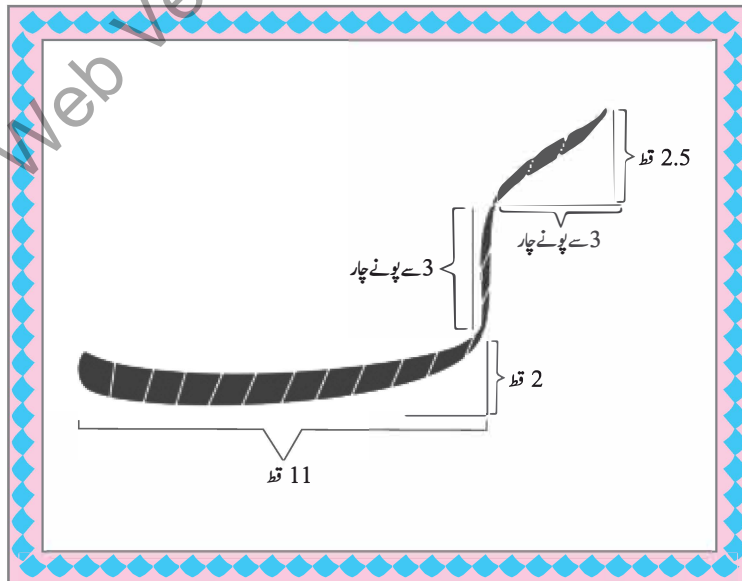

## Urdu Calligraphy Practice # 17

### The Anatomy of letter *Ghaf* in *Nastalique*

#### Material

1. *Qalam*
2. Paper
3. Ink

Note: Follow the instructions given in the diagram to learn the complete anatomy of the letter *Ghaf* in *Nastalique* script.

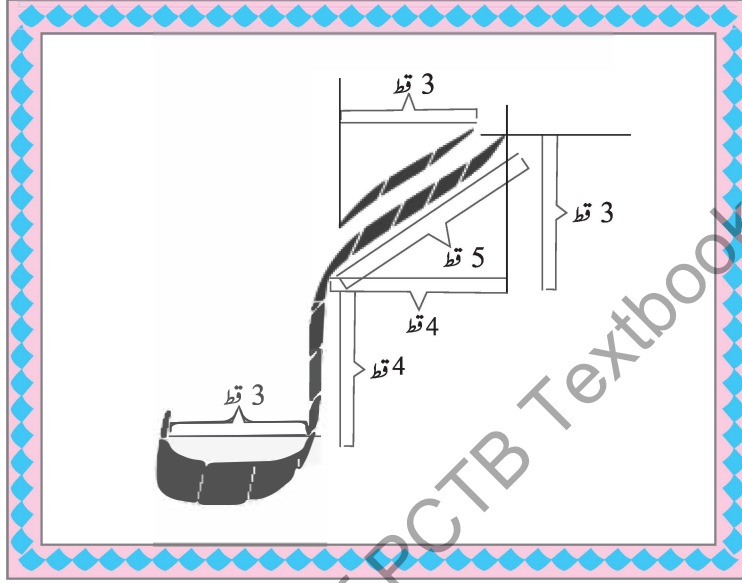

## Urdu Calligraphy Practice #18

### The Anatomy of letter *Laam* in *Nastalique*

#### Material

1. *Qalam*
2. Paper
3. Ink

Note: Follow the instructions given in the diagram to learn the complete anatomy of the letter *Laam* in *Nastalique* script.

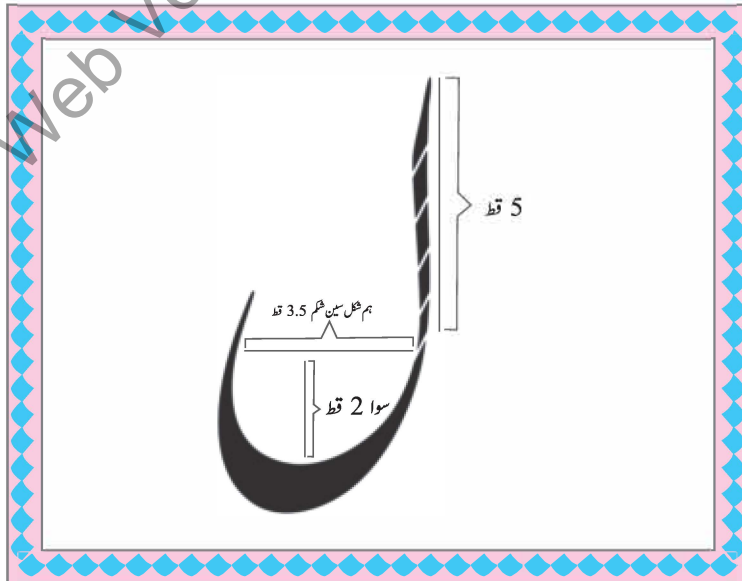

## Urdu Calligraphy Practice # 19

### The Anatomy of letter *Meem* in *Nastalique*

#### Material

1. *Qalam*
2. Paper
3. Ink

Note: Follow the instructions given in the diagram to learn the complete anatomy of the letter *Meem* in *Nastalique* script.

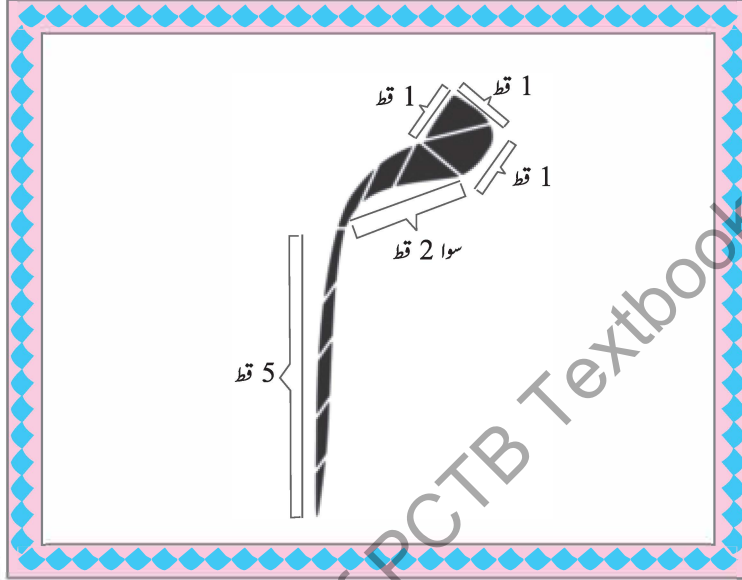

## Urdu Calligraphy Practice #20

### The Anatomy of letter *Noon* in *Nastalique*

#### Material

1. *Qalam*
2. Paper
3. Ink

Note: Follow the instructions given in the diagram to learn the complete anatomy of the letter *Noon* in *Nastalique* script.

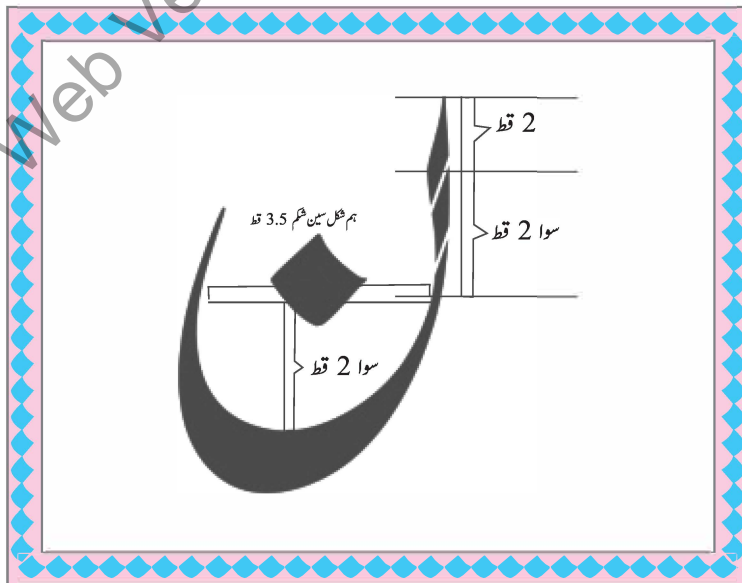

## Urdu Calligraphy Practice # 21

### The Anatomy of letter *Vao* in *Nastalique*

#### Material

1. *Qalam*
2. Paper
3. Ink

Note: Follow the instructions given in the instructions given in the diagram to learn the complete anatomy of the letter *Jeem* in *Nastalique* script.

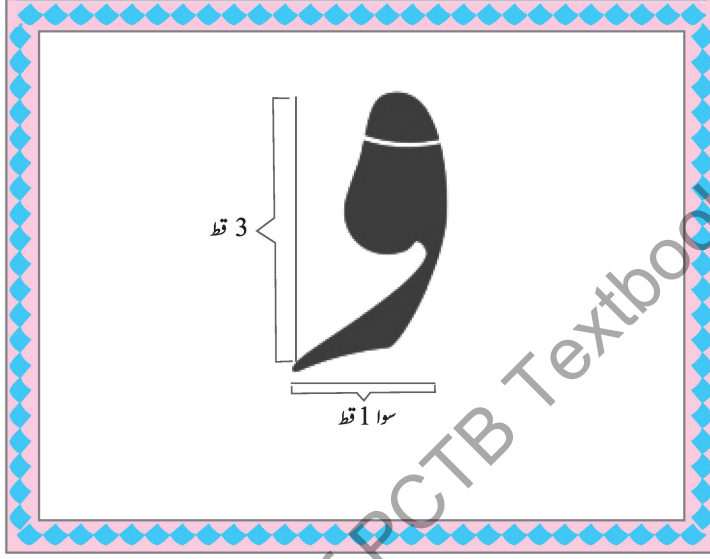

## Urdu Calligraphy Practice #22

### The Anatomy of letter *Hay* in *Nastalique*

#### Material

1. *Qalam*
2. Paper
3. Ink

Note: Follow the instructions given in the diagram to learn the complete anatomy of the letter *Hay* in *Nastalique* script.

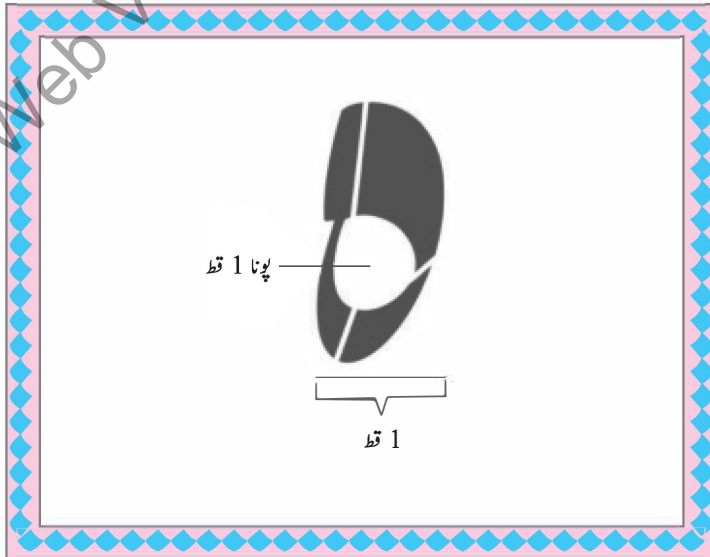

## Urdu Calligraphy Practice # 23

### The Anatomy of letter Hay (dochashmi) in *Nastalique*

#### Material

1. *Qalam*
2. Paper
3. Ink

Note: Follow the instructions given in the diagram to learn the complete anatomy of the letter *Hay(dochashmay)* in *Nastalique* script.

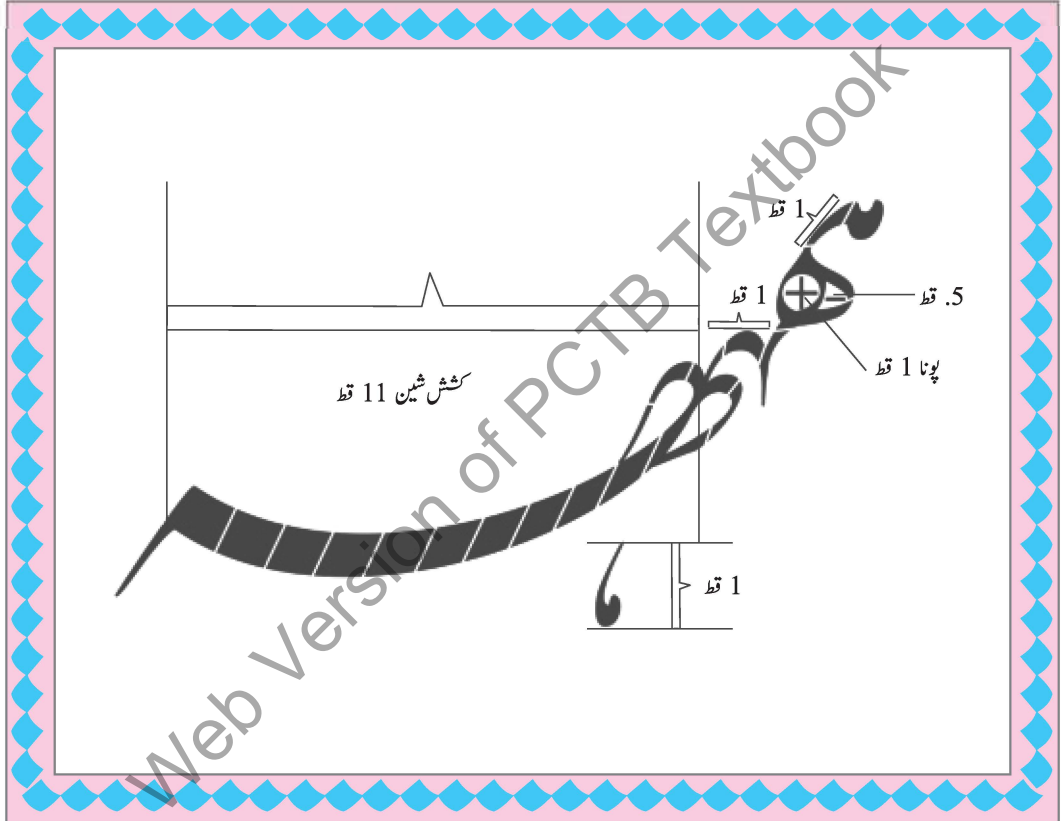



## Urdu Calligraphy Practice # 23

### The Anatomy of letter Hamza in *Nastalique*

#### Material

1. *Qalam*
2. Paper
3. Ink

Note: Follow the instructions given in the diagram to learn the complete anatomy of the letter *Hamza* in *Nastalique* script.

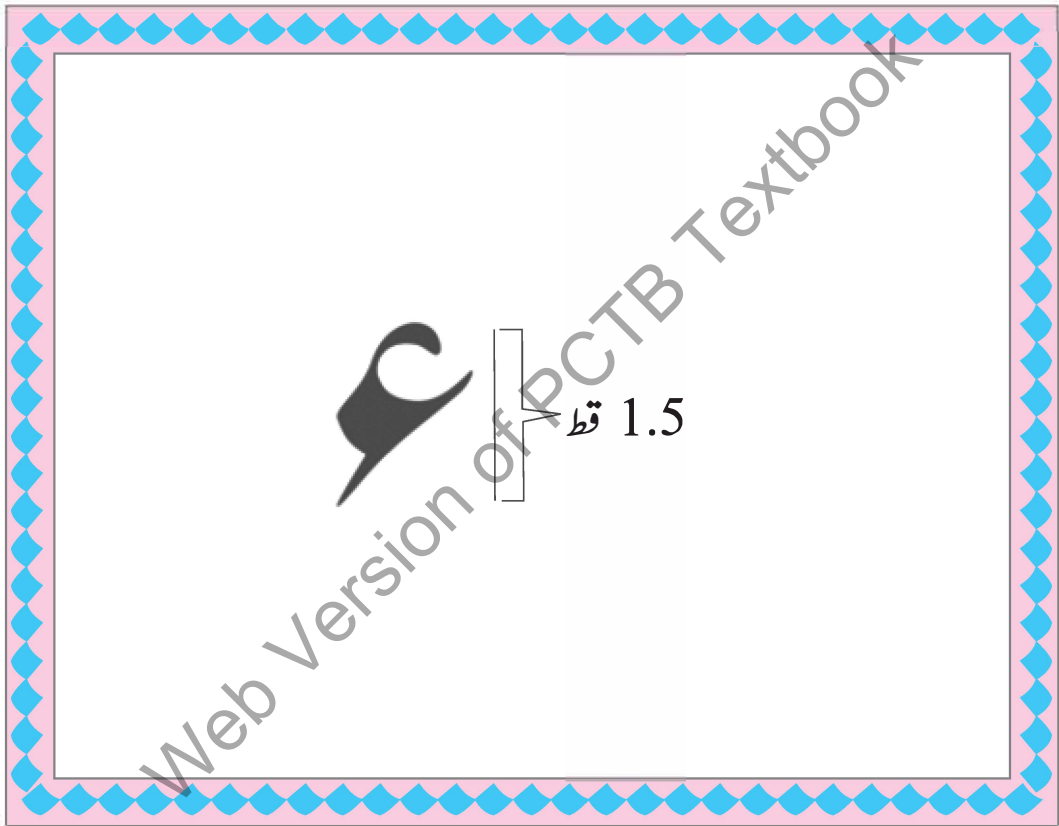

## Urdu Calligraphy Practice # 25

### The Anatomy of letter *Yay (choti)* in *Nastalique*

#### Material

1. *Qalam*
2. Paper
3. Ink

Note: Follow the instructions given in the diagram to learn the complete anatomy of the letter *Yay (choti)* in *Nastalique* script.

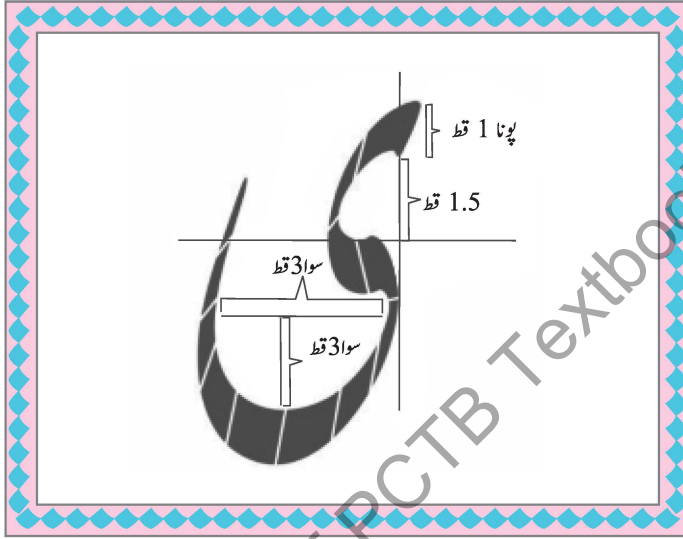

## Urdu Calligraphy Practice #26

### The Anatomy of letter *Yay (Bari)* in *Nastalique*

#### Material

1. *Qalam*
2. Paper
3. Ink

Note: Follow the instructions given in the diagram to learn the complete anatomy of the letter *Yay (Bari)* in *Nastalique* script.

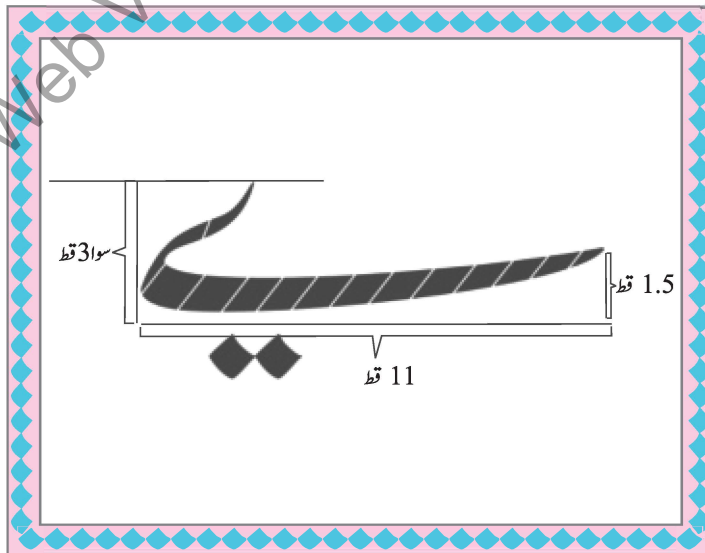

## Urdu Calligraphy Practice # 27

Exercise of *Bay*



## Exercise of Jeem

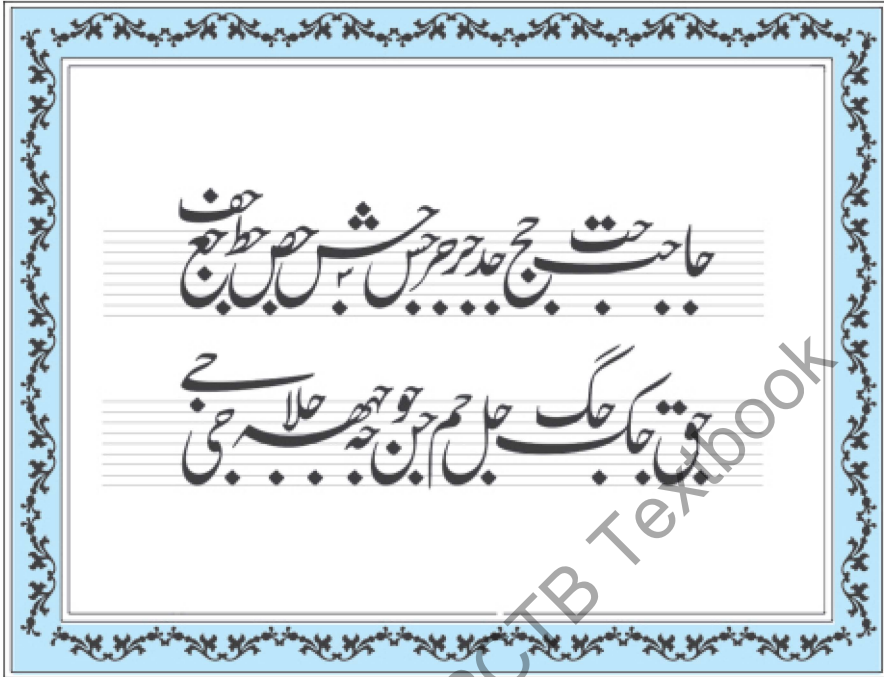

## Exercise of Seen

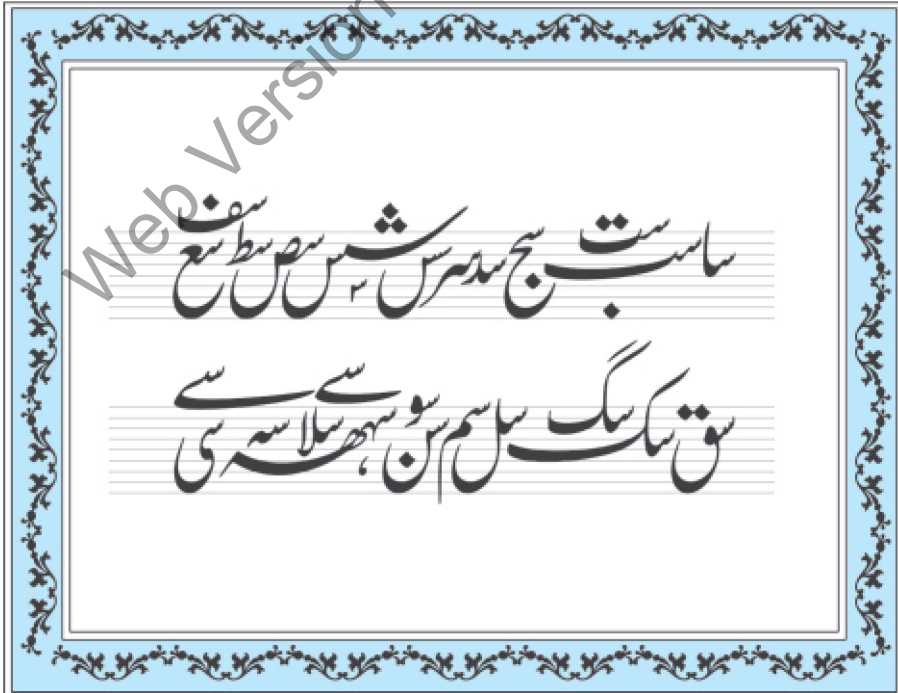

## Exercise of *Suaad*

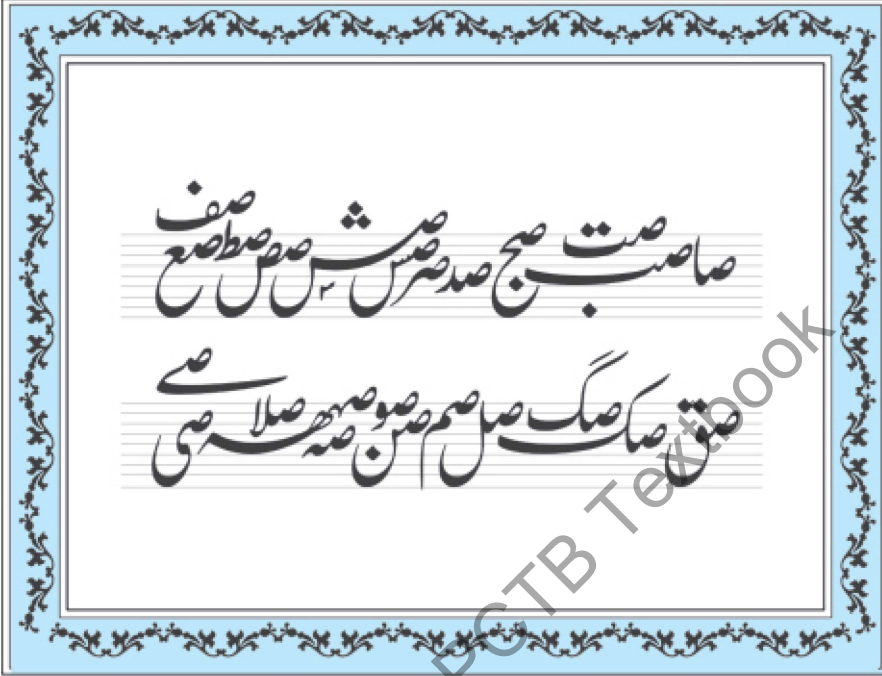

## Exercise of *Toa*

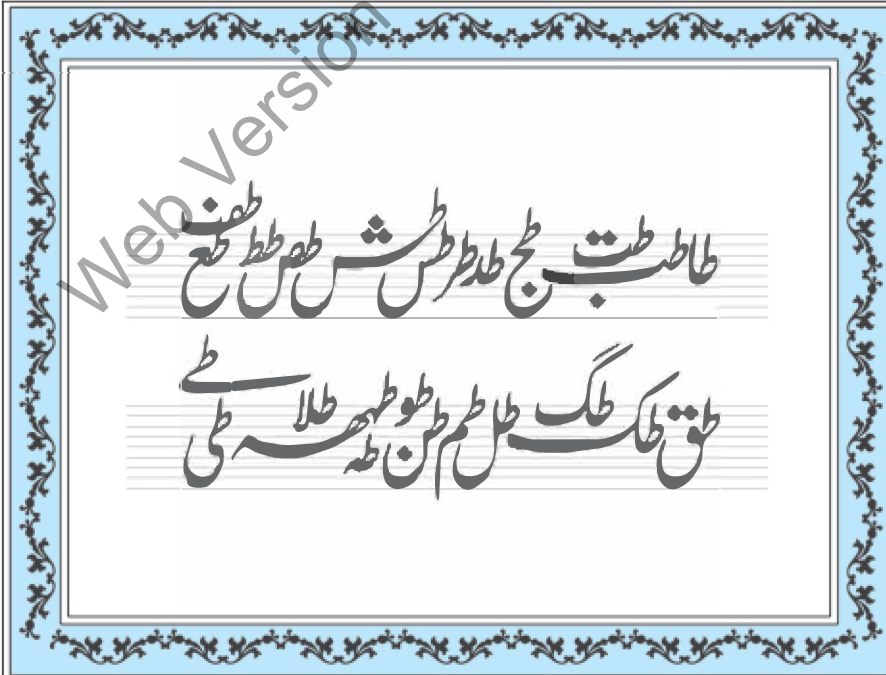

## Exercise of *Ain*

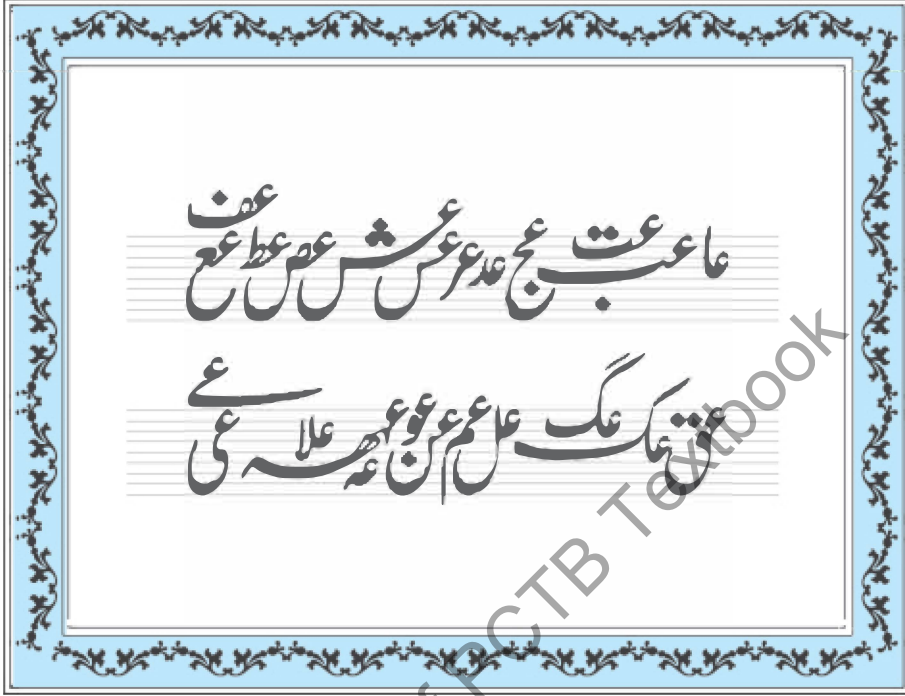

## Exercise of *Fay*

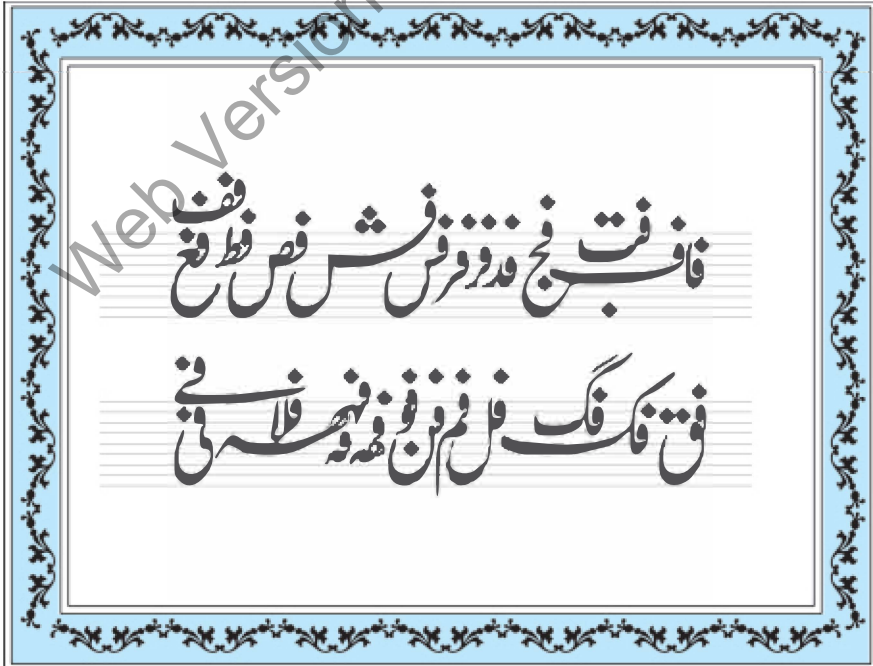

## Exercise of *Ka'f*

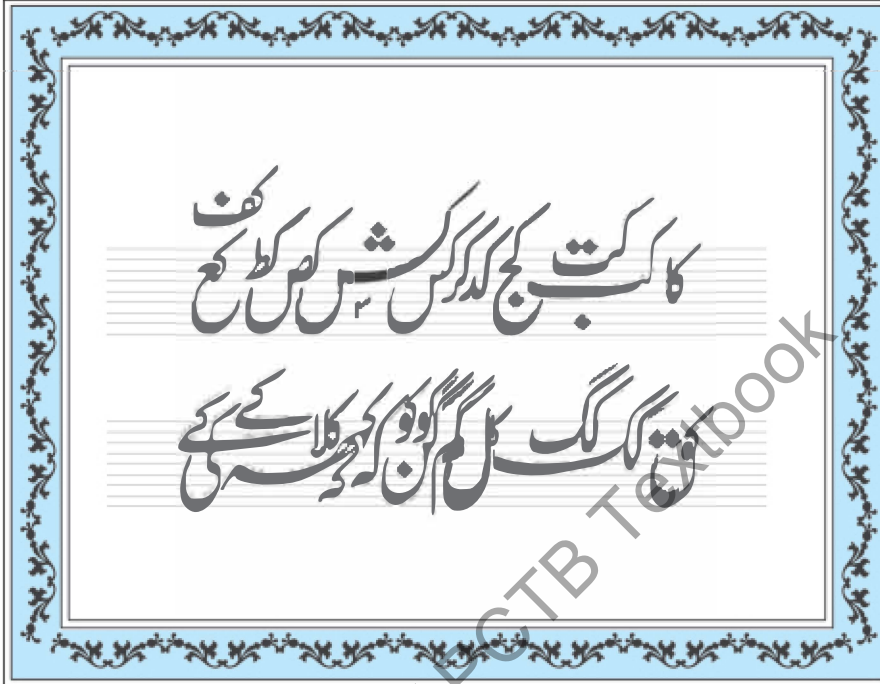

کاکت کج گگ کس کس کس کس کس  
ق ق ق ق ق ق ق ق ق ق ق ق

## Exercise of *Meem*

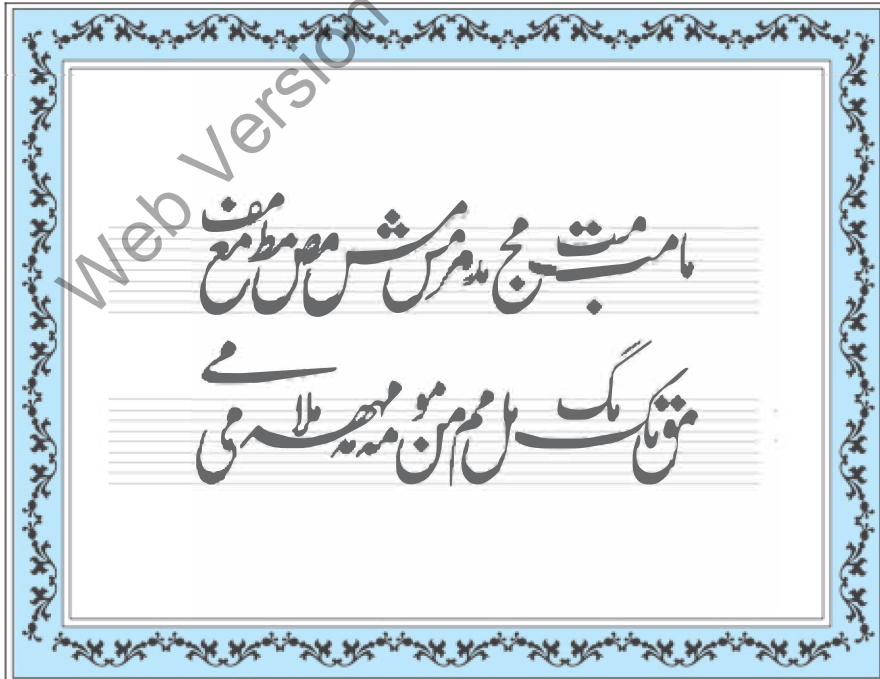

ما م م م م م م م م م م م م  
ق ق ق ق ق ق ق ق ق ق ق ق

## Exercise of *Hay*



ماہانہ بنتی ہجرت ہرگز نہیں ہرگز نہیں ہرگز نہیں ہرگز نہیں  
میتو گاہک ہاں ہم ہیں ہاں ہم ہیں ہاں ہم ہیں ہاں ہم ہیں



## 4.3 English Calligraphy

The history of English language in Pakistan begins with the historical facts and figures of the subcontinent. The early history of this language in this region starts in 16th century with the arrival of British people in India. “It received official recognition with the passing of Macaulay's minutes of 1835. Throughout the British era, English kept gaining political domain and social status. In fact, by 1947, when Pakistan and India gained their independence from the British, the English language had become so entrenched in the socio-political fabric of the region that both countries maintained its role in the new states.”<sup>3</sup>

In contemporary Pakistan, English language is still holding a prominent place among the public and private life. This language is playing a vital role in advertising and marketing. Posters and advertisements on every media share the information in this language. Writing of English in more aesthetic manners is becoming crucial for fashion and advertising industry. 'Round-hand script' is one of the most famous and simplest fonts in English calligraphy. It was very famous among “the English writing masters of 18th century whose copybooks were splendidly printed from models engraved on metal.”<sup>4</sup> Fundamentally, the alphabets of this script are written in a sloped form of 30 to 40 degrees to the right. Thick lines are created in down strokes through applying pressure on a flexible flat edged nib. Thin lines are created by the edge of the nib. The use of flat tip nib is almost similar to the use of bamboo *qalam* (pen) in Urdu and Arabic calligraphy but with a different direction of nib.

### Tools and material for Round-hand Calligraphy

For practicing round-hand calligraphy the following material will be required:

1. Flat tipped pen nib
2. Pen holder
3. Water proof ink
4. Pencil
5. Eraser
6. Practice sheet



<sup>3</sup> Ahmar Mahboob, “The English language in Pakistan: a brief overview of its history and linguistics”. *Pakistan journal of language* 4, no. 1 (2003): 1-28.

“Robert Williams, *Round Hand Script Calligraphy*,

<sup>4</sup> <https://www.britannica.com/topic/round-hand-script> (Accessed on July 20 2018)

## English Calligraphy Practice # 1 Round-hand Script

To learn the Round-hand Calligraphy initially, a practice of straight, cursive and diagonal lines proves beneficial for learner. It will make the practitioner aware of the use of flat tip nib and the flow of ink on paper.

1. First get the writing material mentioned in the required material list for this calligraphy and take 4 to 5 prints of calligraphy sheet with four lines on a smooth card paper or good quality Bristol paper available in the market. Start warm up practices using downward strokes with flat nib pen as given below and repeat this practice on two to three lines.



2. Then practice a basic cursive stroke of 'C' shape on two to three lines as given below:



This exercise will enable the practitioner to gain the flow of hand for writing this script.

## English Calligraphy Practice # 2 Lower Case Alphabets Round-hand Script

1. Round-hand script is a beautiful blend of cursive and diagonal down stroke lines. Such kind of formation of lettering give a liberty to the writer when he writes the letters, he may join the one alphabet to the other or leave them alone. Practice of lower case will give an understanding of the complete nature of this script. Below is the image of lower case. The blue arrows indicate the direction in which the practitioner has to move the pen, while numbers suggest quantity of strokes.

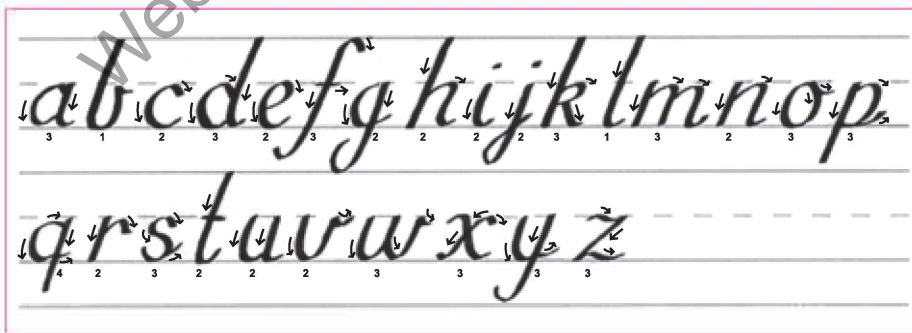

Copy these letters 4 to five times on practicing sheets and proceed with the next exercise for deeper understanding of these letters.

2. In the following image, the breakup of each down stroke letter suggests how many strokes are required for the letters like, b, f, h, i, j, k, l, m, n, p, r, s, t, x, and z.

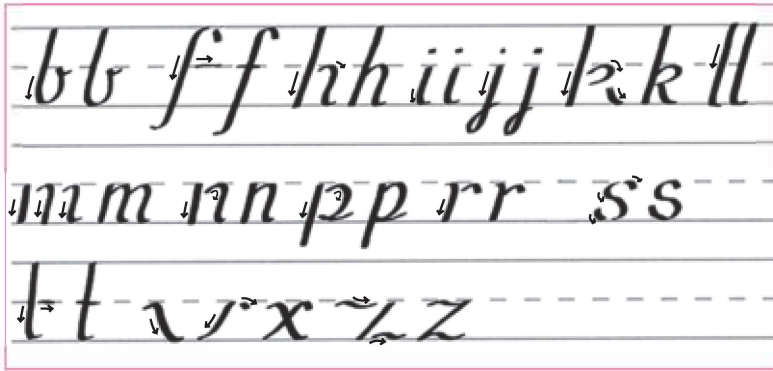

### English Calligraphy Practice #3

#### Exercise the lowercase letter 'h'

1. Start practicing the single letter with a complete understanding of its proportion and anatomy. For writing 'h' place the pen making a horizontal position of flat nib pen and move it down till the bottom line. Then lift the pen and place it just along the dashed line, make a downward stroke with a small curl up at the end, according to the image given below.

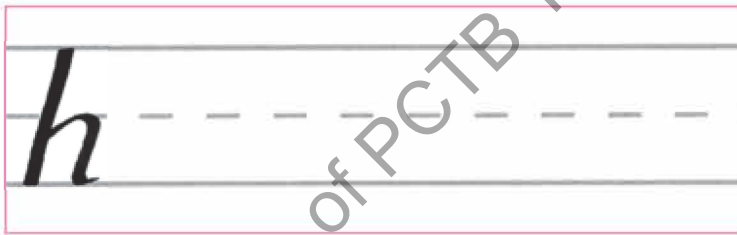

2. Repeat making the letter 'h' three or more times so that you may understand its anatomy. The practice of letters d, f and k is very similar to the practice of 'h' so you may practice these letters along with 'h'.

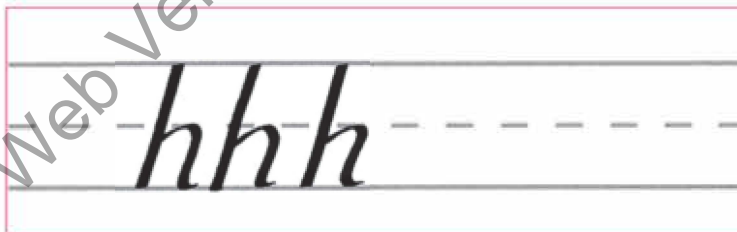

3. Now practice the letter 'k' with same manners placing the flat nib at the top line and make a down stroke till the bottom line. Then place the nib along the dashed line and make downward stroke of the shape given bellow.

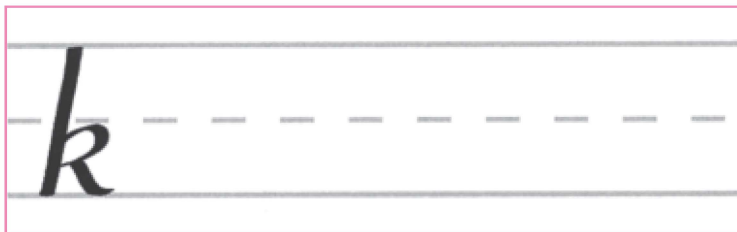

4. Repeat the practice of letter 'k' three times or more.



### English Calligraphy Practice # 4 Lower case round-hand curved strokes letters

1. The practice of the letters which start with curved strokes is given below with the breakup of each letter having blue arrows to show the direction of each stroke. Observe and practice the letters a, c, d, e, g, o, q, u, v, w and y.

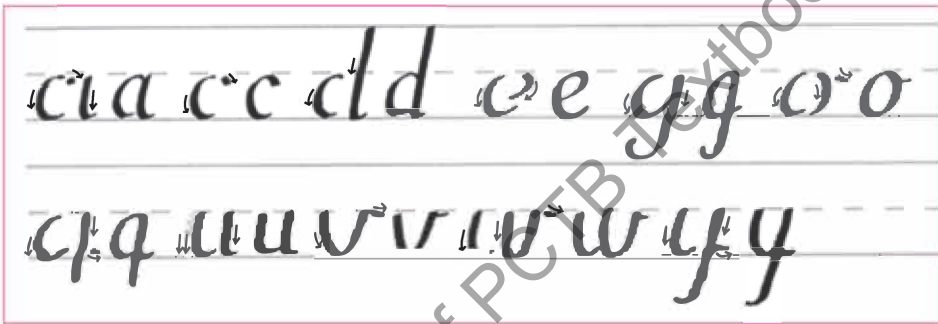

2. Then start practicing each curved letter separately observing its shape and flow.

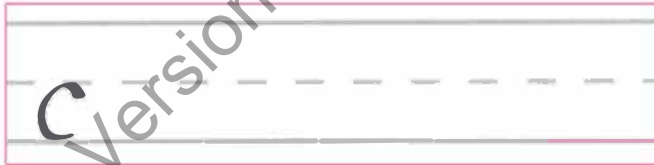

3. Repeat the letter three or more than three times.



4. Letters like 'e' and 'o' makes two curved strokes that can be observed in the image below. Once you learn how to write 'c' you can practice of the flowing two curved strokes. These will also be placed under the dashed line till the second last straight line.

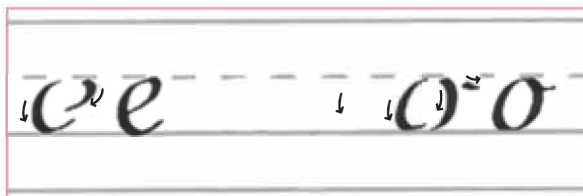

1. Now practice the letter 'q' with one curved and one downward stroke. According to its placement on the lower lines.

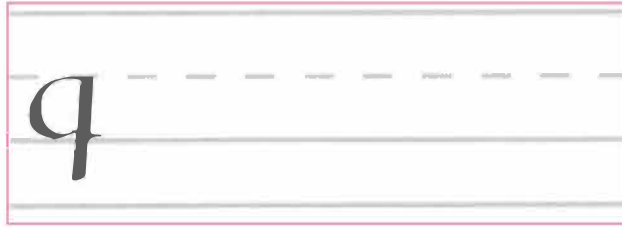

Repeat the letter 'q' three or more than three times for practice.



1. After practicing each letter multiple times now practice all the letters altogether several times to get command on the lower case of the style Round-hand writing.



Several practices of these instructions will enable the student to have a great command on writing in this style fluently and perfectly.

### **English Calligraphy Practice #5** **Uppercase Alphabets of Round-hand Script**

1. The uppercase alphabets of Round-hand script are written by a bit different rules with more elaborated curves and strokes. Mostly the curved strokes are bigger, while downward strokes are elaborated with stylized flair. The practice of these letters is also as simple as it was with the lowercase. For making it more convenient the practitioner may use a pencil to draw the structure of each alphabet then redo it with flat nib pen following the pencil lines. The following image is suggesting the directions and number of strokes for this practice.

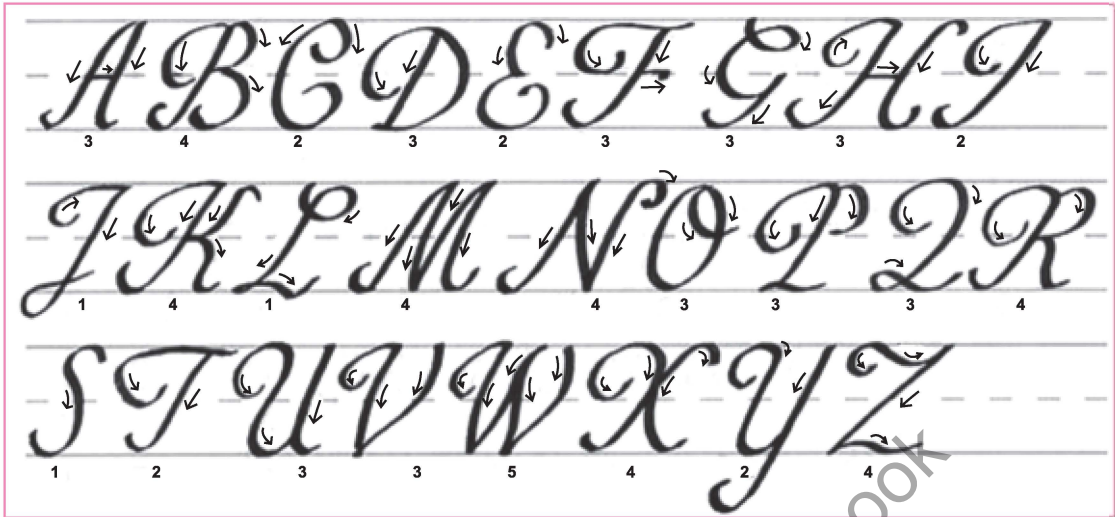

1. Mostly the letters in uppercase Round-hand start with curved strokes. Start practice with letter 'c'. Place the pen in center of upper two lines and making a curvilinear stroke and move it downward making a 'c' shape till the bottom line then, move the pen upward forming same kind of curvilinear stroke of the upper side but now from bottom to upward. Observe the image below.

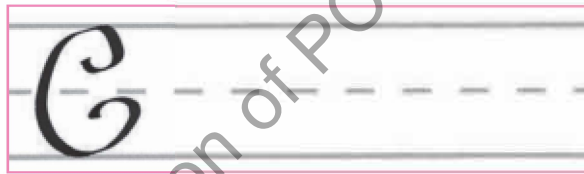

1. Repeat the letter C three or more than three times.



The practice of upper case letters is more elaborated with bigger, smaller and sweeping lines. Once you get command on the making of letter 'C' it will be easy to practice other uppercase alphabets.

1. Now practice a bit harder letter 'K' in four strokes. Follow the direction and style given in the image to write it perfectly.

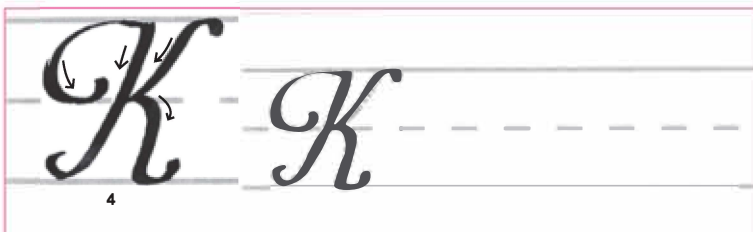

1. Repeat the letter 'K' three or more than three times to get its real feel by using a flat nib pen and moving hand according to the given instructions.

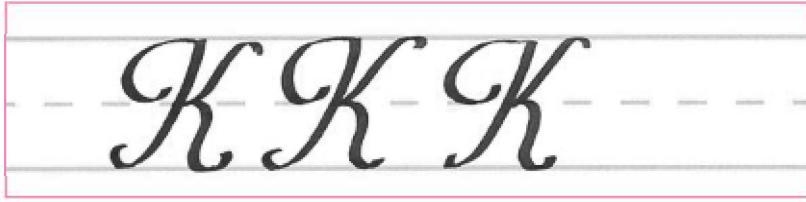

The letter 'K' is very similar to the letters like B, D, F, H, I, J, P, Q, R, T, U, W, X and Y in nature and treatment. Once you get command on letter K continue with the following exercise.

Now exercise all the alphabets altogether according to the instructions, while repeating it several times to get its commandment.



### English Calligraphy Practice # 6

Practice the uppercase and lowercase altogether with more fluent and elaborated curves to get its real impact according to the image given below.



## English Calligraphy Practice #7

### Mixing up the upper and lowercase letters all together

Now practice different sentences and words using your previous practice in more fluent manners.

*Round - hand*

## English Calligraphy Practice #8

### Elaborate your text

According to this exercise elaborate the curves and down strokes of your calligraphy in an artistic way and try to find out your unique style of stylizing and elaborating the letters.



Figure 4.7 Elaborate your text (1)



*Harmony*

Figure 4.8 Elaborate your text

*Mum & Dad*

Figure 4.9 Elaborate your text (3)

## 4.4 Poster Making

Poster is a specific category of image making which is used to convey a message through visuals or the combination of visuals and text. It is a powerful way of communication which needs a careful planning to guarantee that targeted public will understand the message clearly.

There are several types of posters we can observe in our surroundings.

1. Awareness posters
2. Educational posters
3. Advertizing or commercial posters
4. Inspirational and motivational posters
5. Political posters
6. Event posters etc.

The above mentioned types show the subject matters which can be usually found in the posters. There are two categories in making poster: one is handmade posters, which can be done in any of the art making techniques and methods like painting, drawing and collage work etc., and the second one is digital posters which can be developed through different software programs in the computer like Corel Draw and Photoshop etc.

The following examples and exercises will guide the practitioner that how to make a poster in an effective way.



Figure 4.10 Example No. 1: This example is the combination of images and text which clearly suggest its message “don't use the drugs habitually”



Figure 4.11 Example No.2: This poster is again communicating a very strong message of “women rights”. The simple imagery, selected text and limited colours are playing more aesthetically in this example.



Figure 4.12 Example No.3: This is a clear example of advertizing category in which a cold drink is presented with specific colour scheme according to the demand of the product and company.

## Planning of a poster Design

To design a poster in an effective way the following steps will be helpful for the practitioners:-

1. It should be attractive or eye catchy in term of utilizing the design elements, motifs and colour selection according to the subject
2. The composition of images and suitable effective selection of text should be well-organized
3. The poster should be self-explanatory.
4. There must be a strong link of images and text
5. It should be appropriate according to the understanding of the local public.

Note: Keeping in view the above instructions students may give assignments of making the posters with poster colours, watercolours or pencil colours on the given topics by the teachers or from the list given below. And in these posters students will utilize their practices of painting, drawing and calligraphy in an effective way. Following is a list of different topics for poster making.

1. Stop violence against woman
2. Child labor
3. HIV awareness
4. Any event in the college
5. Basant Festival
6. Human rights
7. Child abuse
8. Anti-Narcotics
9. Poster for any product for sale
10. Educational posters

## 4.5.Repeat Patterns

Pattern is a design or motifs, regular or irregular shape in certain sequence. It can be handmade or digitalized. The repeat pattern represents continuity of the basic key design or motif in a specific composition of direction like repetition of one motif in circular, horizontal or vertical sequence. We can find the repeat patterns everywhere in our surroundings like in the designs of wall papers, clothes, carpets, embroideries, pottery and ceramic tiles etc.

Repeat Patterns for Textile: Textiles of all kinds can be designed through a repeated pattern of geometrical, floral, regular or irregular designs. There are infinite traditions and ways to arrange the designs on the fabric but some basic methods are commonly used.

Usually the repeat patterns can be represented into several types especially for textile designs, a few of them are block repeat, mirror repeat, vertical or horizontal boarder repeat, circular repeat, half key repeat etc.

## Block Repeat

For block repeat several other names are used to define this way like basic repeat, square repeat, straight repeat, full-drop repeat, cross repeat etc.

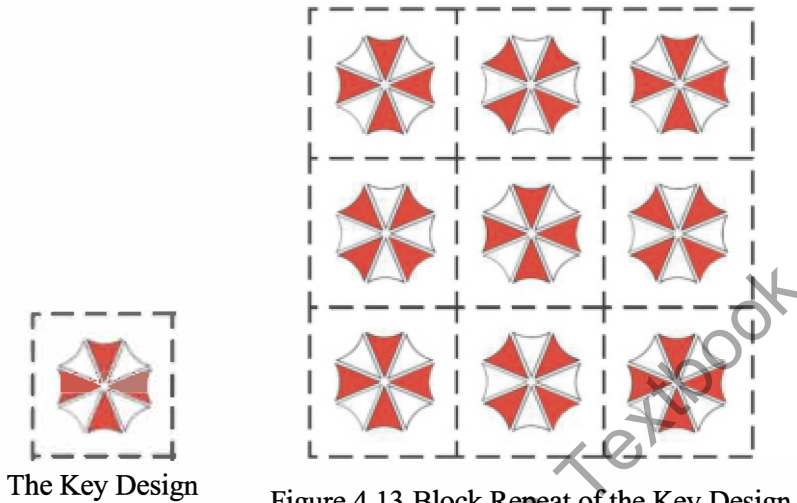

In this type the key is repeated side by side, up and down in symmetrical manners. It is considered as the basic repeat.

### Repeat Pattern Practice # 1 Block Repeat

Make your own repeat patterns of a geometrical and floral key design and repeat it up and down and side by side as is presented in the following examples.

Create a key design in 2inch x 2inch box as a key and make a block repeat. For each exercise of repeat patterns students will use the medium of poster colours.

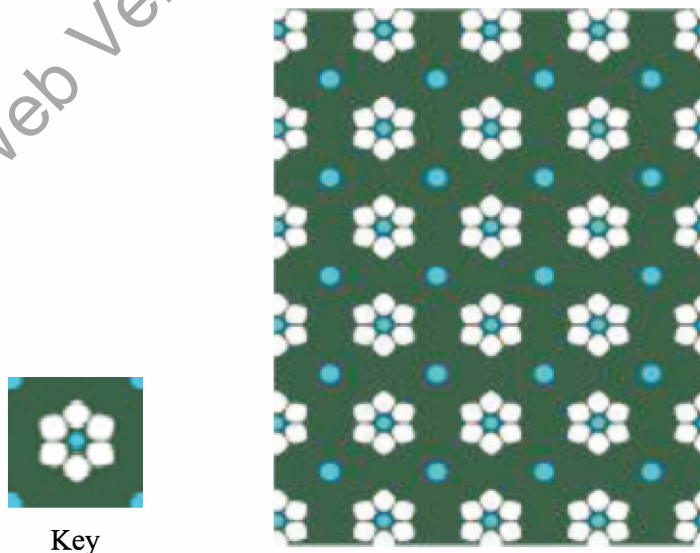



Key

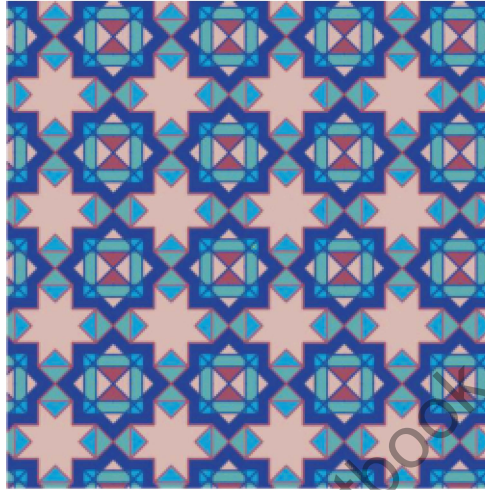

Figure 4.15 Geometrical Design Block Repeat

### Repeat Pattern Practice # 2 Mirror Repeat I

This type represents a repeat of key design side by side in opposite direction like a reflection in the mirror. Its direction can also be up and down. This is an interesting pattern which can make a unique design pattern and holds the attention of the viewer. Following examples are representing flip of the key design up and down and side by side.



Figure 4.16 Mirror Repeat

### Repeat Pattern Practice # 3 Mirror Repeat II

Students will design a repeat pattern of two kinds according the given examples. One can be geometrical or floral design and the other can be a figurative motif like any animal or bird.



### Repeat Pattern Practice # 4 Border Repeat Horizontal and Vertical

Vertical and horizontal border repeat is one of the more versatile repeat patterns because of its use in different fields. It is equally applicable on fabrics, ceramics, paper material and products. Following are two simple examples of this type. One is geometrical and the other is floral.



Figure 4.18 Horizontal border repeat



Figure 4.19 Vertical border repeat

### Repeat Pattern practice #5 Border Repeat

Students will create two types of border repeat patterns: one will be horizontal and the other will be vertical. This time they will show a creative approach for making a different kind of key design which can be other than geometrical or floral motifs.



Figure 4.20 Vertical Repeat with Bird Motif



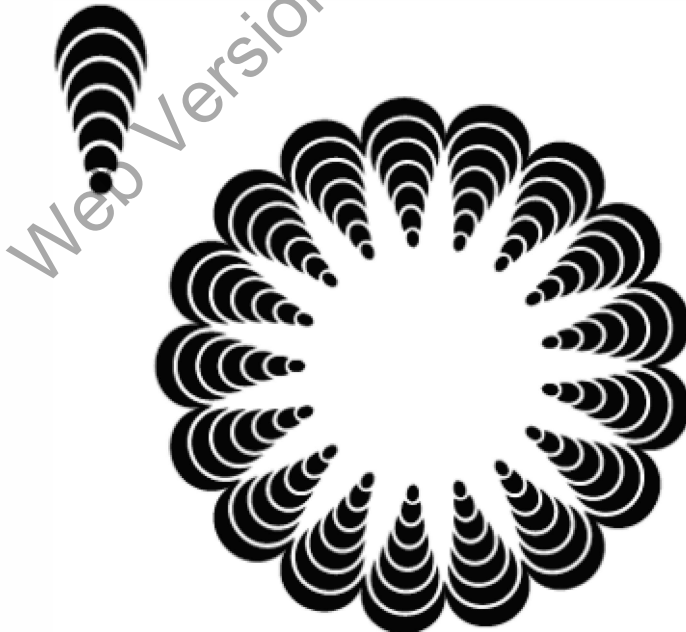

Figure 4.21 Horizontal Repeat with Human Figure

### Circular Repeat Pattern

This type of repeat is usually found on the round pottery or ceramics material. In this type the design of motif runs within a circular repeat. The starting point merged with the ending point in a sense of continuity.

Following is the example of circular repeat with its key design.



## Repeat Pattern Practice # 6 Circular Repeat

The students will create their own unique motifs for this kind of repeat for designing a ceramic plate. Following image will guide them for making the required pattern.

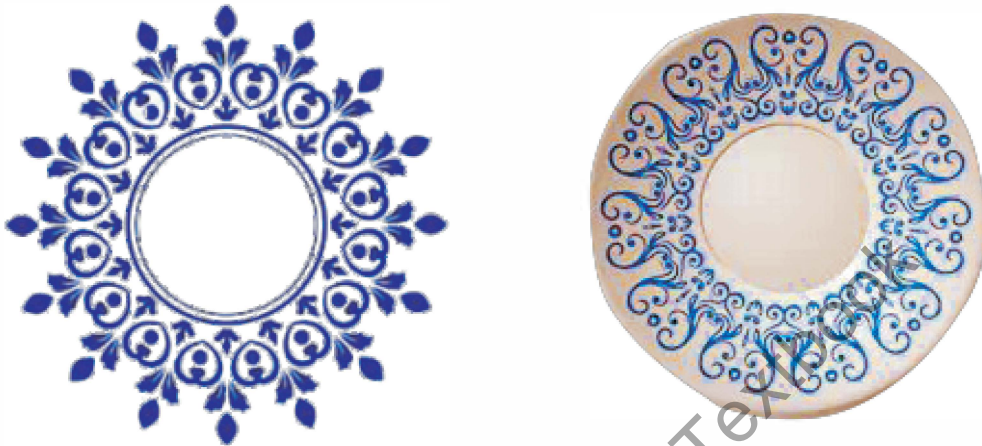

## Reference Images

The following images clearly show different types of repeat pattern with one key design.

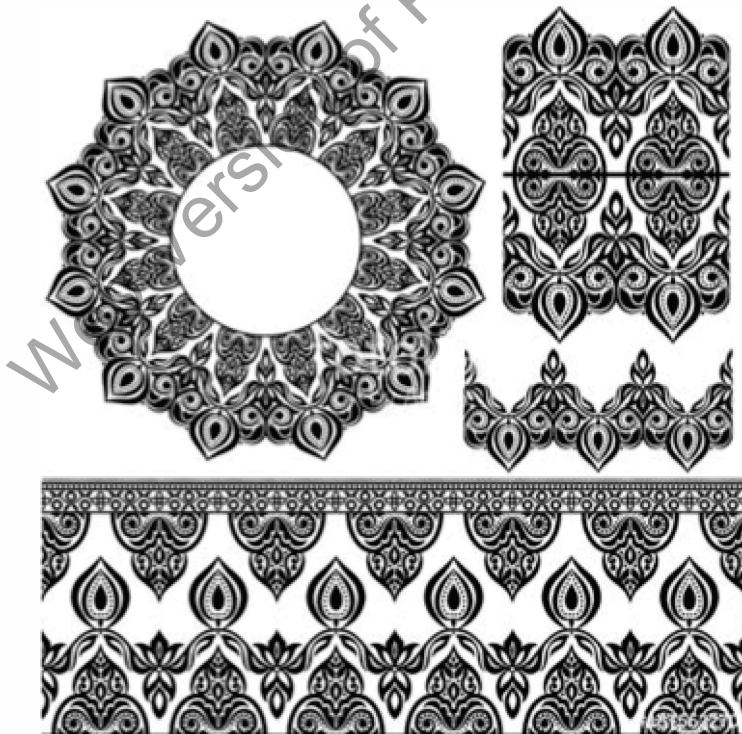

Figure 4.24 Reference image of one key design in several types of repeat

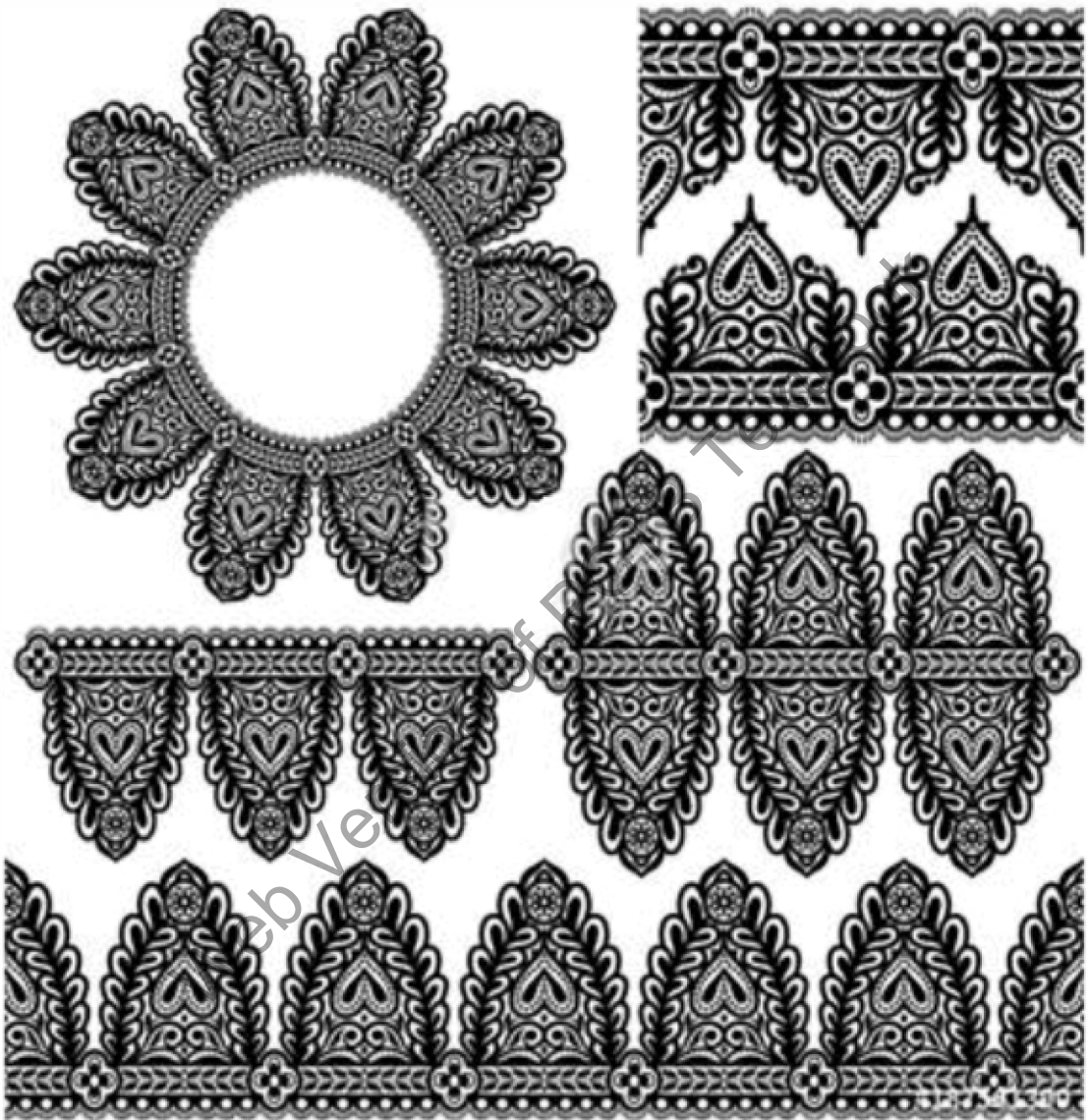

Figure 4.25 Reference image of one key design in several types of repeats



Figure 4.26 Reference image for ceramic pot repeat



Figure 4.27 Reference image for ceramic pot with repeat design



Figure 4.28 Reference image for ceramic tile repeat design



Figure 4.29 Reference image for textile repeat design