CHAPTER

1

Introduction

Animation 11.1: Levels of Organization
Source & Credit: wonderwhizkids

BIOLOGY AND SOME MAJOR FIELDS OF SPECIALIZATION

Biology is the study of living things. It is a branch of science and like other sciences it is a way of understanding nature. Biologists deal with the living part of nature and with the non-living things which affect the living things in any way. They strive to understand, explain, integrate and describe the natural world of living things. The literal meaning of biology is the study of life.

It is very difficult to define life. There are certain aspects of life that lie beyond the scope of the science of biology like the answers to the questions: what is the meaning of life? Why should there be life? These are the questions not usually taken up by Biologists and are left to philosophers and theologians. Biologists mainly deal with the matters relating to how life works.

Life, for biologists, is a set of characteristics that distinguish living organisms from non-living objects (including dead organisms). Living organisms are highly organized, complex entities; are composed of one or more cells; contain genetic program of their characteristics; can acquire and use energy; can carry out and control numerous chemical reactions; can grow in size; maintain a fairly constant internal environment; produce offspring similar to themselves; respond to changes in their environment.

Any object possessing all these characteristics simultaneously can be declared as a living thing and is an object for biological studies.

The science of biology is a very wide based study. It includes every aspect of a living thing. Therefore, volumes and volumes of information are available under this major head. It is but natural to divide the science into quite a number of branches for our convenience of comprehending and studying biology.

You are surely familiar, at this stage, with Ecology, Embryology, Physiology, Morphology (external Morphology or Anatomy), Palaeontology, Histology, Evolution, Genetics, Zoogeography etc. These are branches of biology which deal with environmental relations, development, functions, structure, form and internal gross structure, fossil, tissues, ancestral history, heredity and distribution of animals in nature, respectively. In addition to these branches there are a number of other branches of biology such as: Molecular Biology, microbiology, Marine Biology, Environmental Biology, Freshwater Biology, Parasitology, Human Biology, Social Biology, Biotechnology, etc.

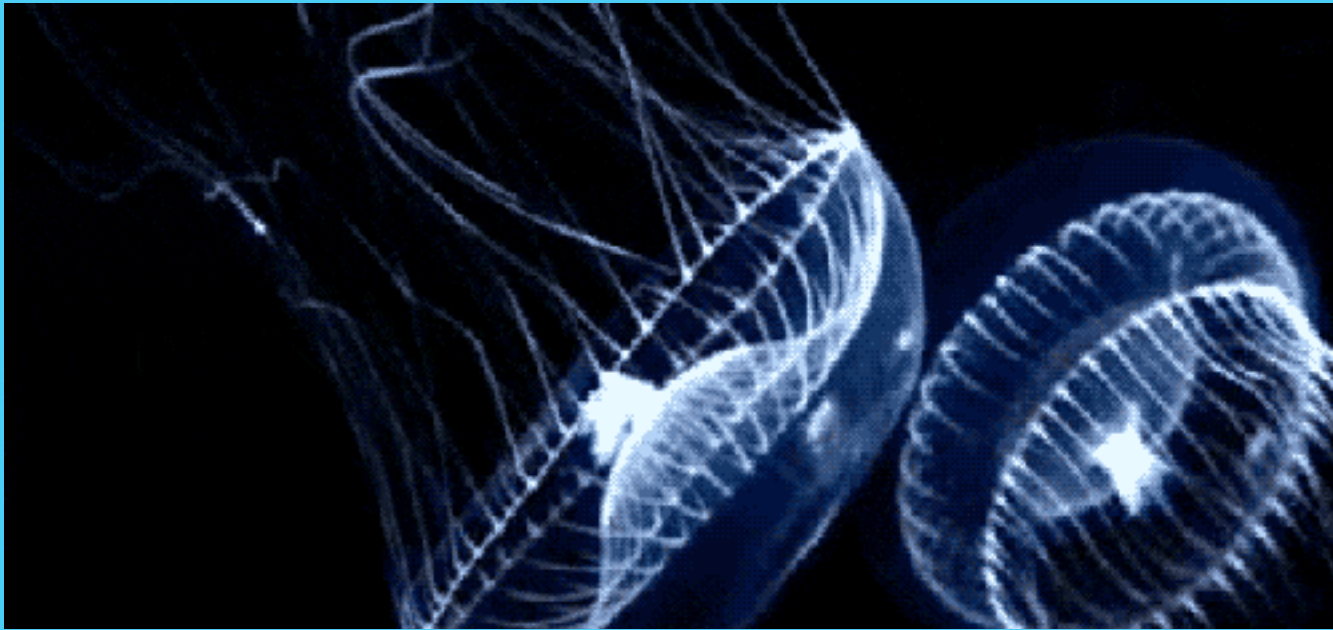

*Animation 11.2 : Biology
Source & Credit: popkey*

Molecular Biology

Molecular biology is a branch of biology which deals with the structure of organisms, the cells and their organelles at molecular level.

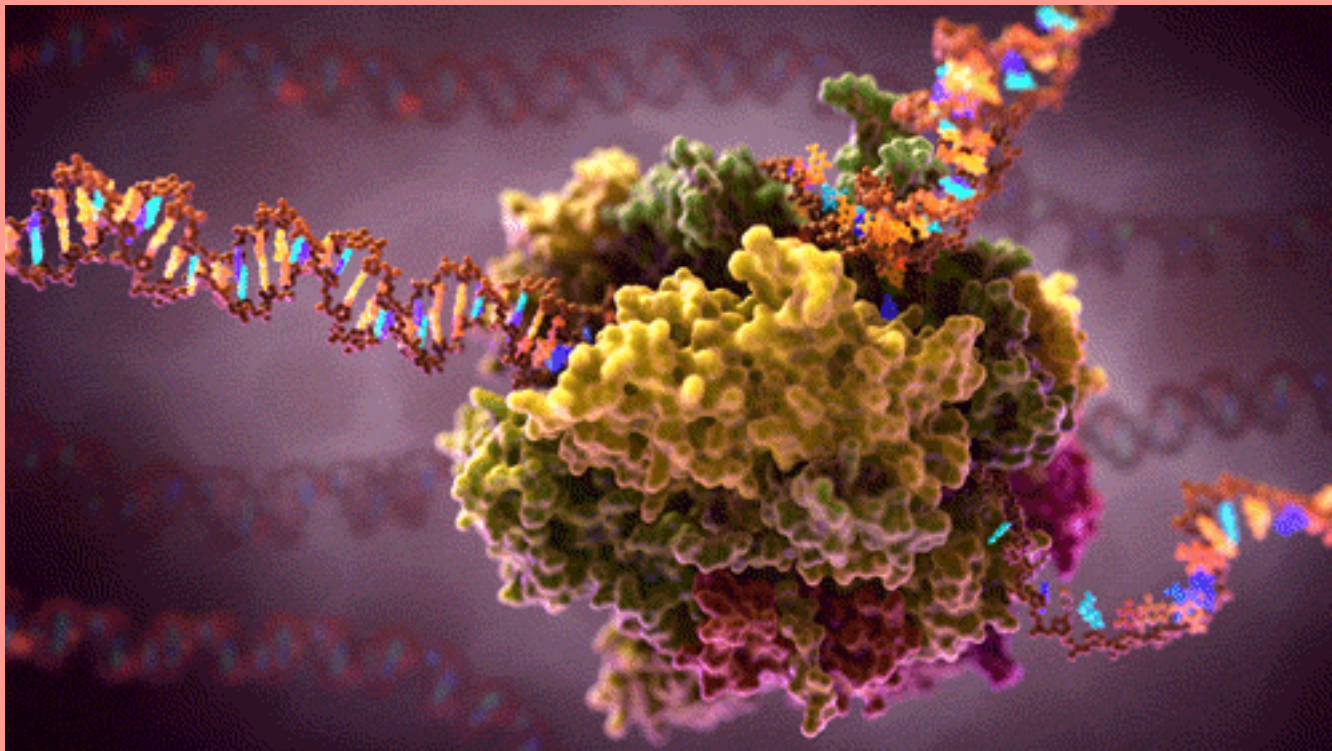

*Animation 11.3 : Molecular Biology
Source & Credit: wifflegif*

Environmental Biology

Environmental Biology is the study of organisms in relation to their environment. This includes interaction between the organism and their inorganic and organic environment, especially as it relates to human activities.

Microbiology

This is the study of microorganisms which include Bacteria, Viruses, Protozoa and microscopic algae and fungi..



Animation 11.4 : Microbiology
Source & Credit: giphy

Freshwater Biology

This branch of biology deals with the organisms living in freshwater bodies i.e., rivers, lakes etc and physical and chemical parameters of these water bodies.



Animation 11.5: Freshwater Biology
Source & Credit: primogif

Marine Biology

This is the study of life in seas and oceans. This includes the study of the marine life and the physical and chemical characteristics of the sea acting as factors for marine life.

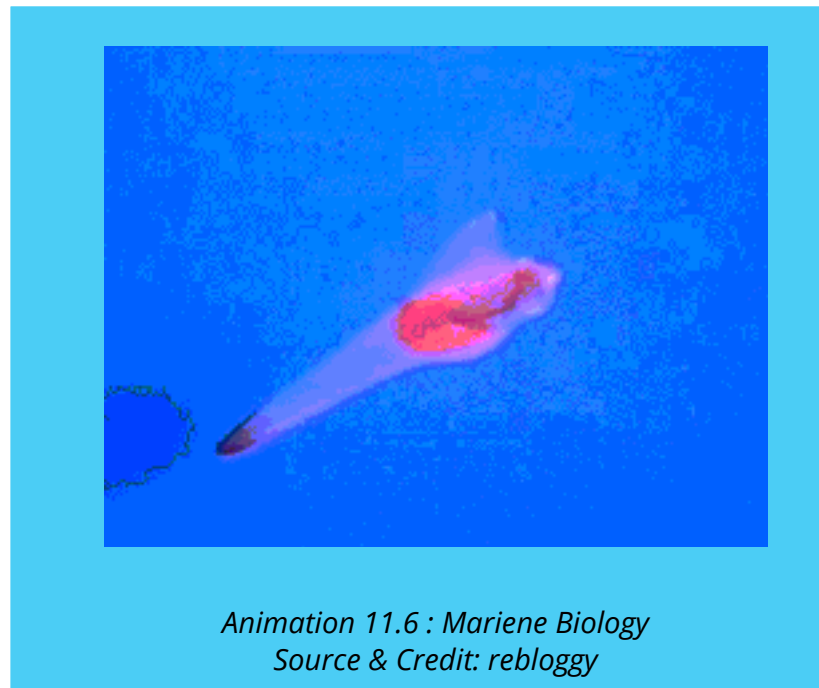

Parasitology

This is the branch of biology which deals with the study of parasites. The structure, mode of transmission, life histories and host - parasite relationships are studied in parasitology.

Human Biology

It deals with the study of man. This includes form and structure, function, histology, anatomy, morphology, evolution, genetics, cell biology and ecological studies etc. of human beings.

Social Biology

This is the branch of biology which deals with the study of social behaviour and communal life of human beings.

Biotechnology

It deals with the use of living organisms, systems or processes in manufacturing and service industries.

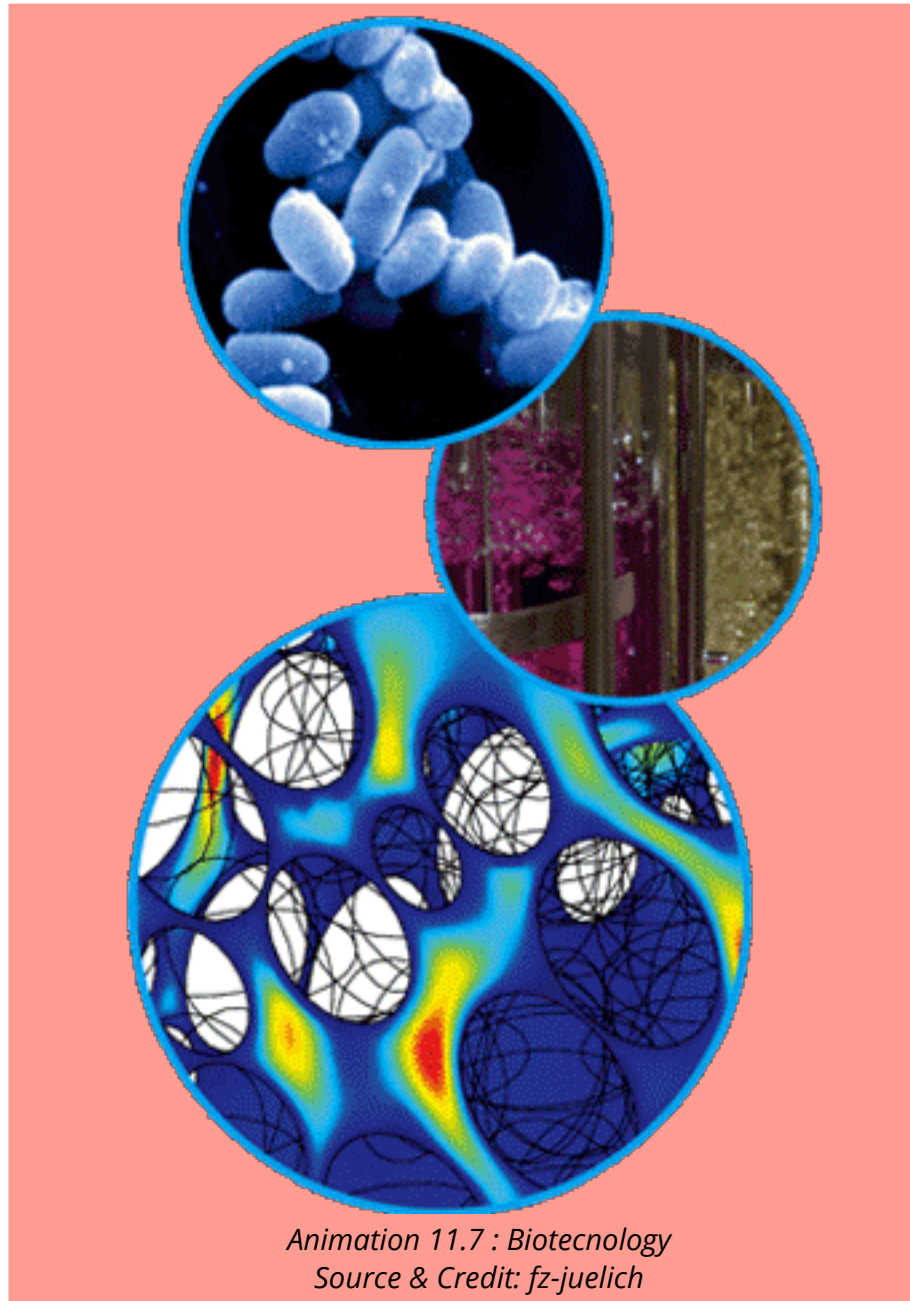

LEVELS OF BIOLOGICAL ORGANIZATION

Hundreds of chemical reactions are involved in maintaining life of even the simplest organism. In view of this, it is something of surprise to find that of the 92 naturally occurring chemical elements, only 16 are commonly used in forming the chemical compounds from which living organisms are made. These 16 elements and a few others which occur in a particular organism are called bioelements.

In the human body only six bio-elements account for 99% of the total mass.

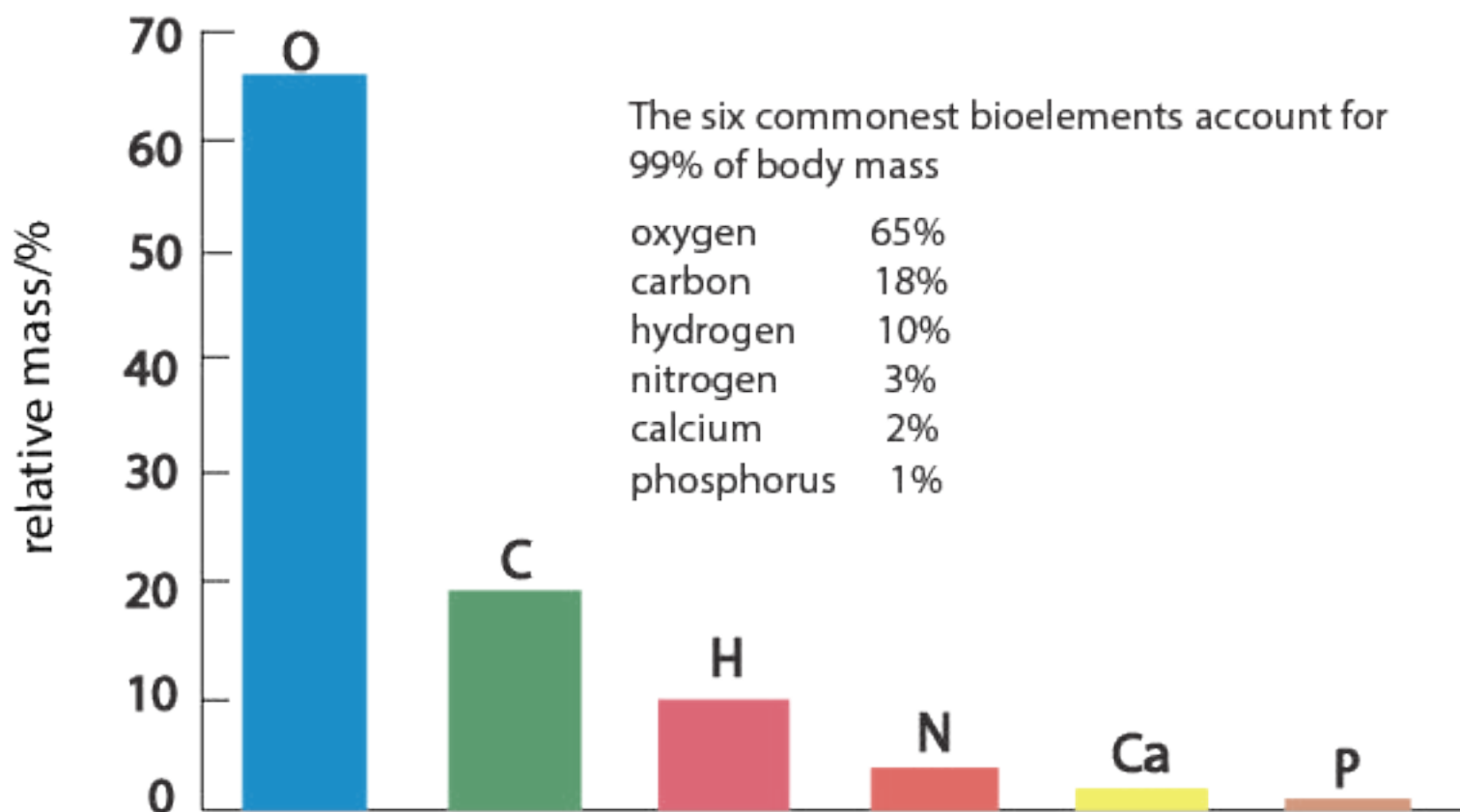

Other bioelements include (about 1%) - potassium (0.35%), sulphur (0.25%), chlorine (0.15%), sodium (0.15%), magnesium (0.05%), iron (0.004%), copper (trace), manganese (trace), zinc (trace), iodine (trace).

Fig 1.1 Percentage composition of bioelements by mass of a human being

The fact that the same 16 chemical elements occur in all organisms, and the fact that their properties differ from those in the non living world, shows that bioelements have special properties which make them particularly appropriate as basis for life.

Biological organization is not simple. It has high degree of complexity because of which the living organisms are able to carry out a number of processes (some very complicated) which distinguish them from the non living things. A living thing has built-in regulatory mechanisms which interact with the environment to sustain its structural and functional integrity.

A living thing is, therefore, composed of highly structured living substance or protoplasm. In order to understand the various phenomena of life, biologists for their convenience, study the biological organization at different levels starting from the very basic level of sub atomic and atomic particles to the organism itself and beyond which the study of community, population and entire world are included.

Biological organization can be divided into the following levels.













Biosphere	That part of earth inhabited by living organism; includes both the living and the nonliving components	
Ecosystem	A community together with its nonliving surroundings	
Community	Two or more populations of different speices living and interacting in the same area	
Population	Members of one species inhabiting the same area	
Species	Very similar, potentially interbreeding organisms	
Multicellular Organism	An individual living thing composed of many cellls	
Organ System	Two or more organs working together in the execution of a specific body function	
Organ	A structure normally composed of several tissue types that form a functional unit	
Tissue	A group of similar cells that perform a specific function	
Cell	The unit of life	
Organelle	A structure within a cell that performs a specific function	
Micro-molecules and Macro molecules	A combination of atoms	
Atom	The smallest particle of an element that retains the properties of that element	
Subatomic Particles	Particles that make up an atom	

Fig 1.2 . Levels of Organization

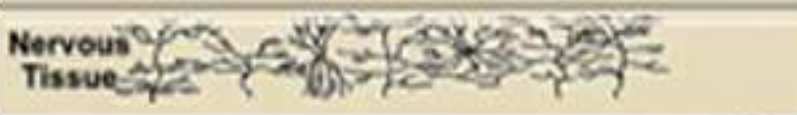
Atomic & Subatomic Levels

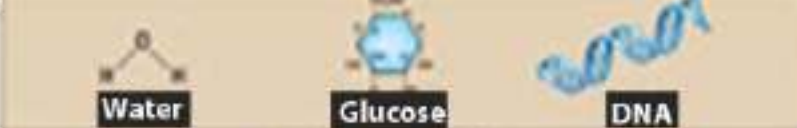
All living and nonliving matter is formed of simple units called atoms and sub atomic particles such as protons, electrons & neutrons.

Molecular Level

In organisms elements usually do not occur in isolated forms. The atoms of different elements combine with each other through ionic or covalent bonding to produce compounds. This stable form is called a molecule. Hydrogen, carbon, oxygen, nitrogen, phosphorous and Ca are the most common atoms found in biological molecules. The different types of bonding arrangement permit biological molecules to be constructed in great variety and complexity. These may be **micromolecules** with low molecular weight like CO_2 , H_2O etc. or **macromolecules** with high molecular weights e.g. starch, proteins etc.

Biological world has two types of molecules: organic and inorganic. An organic molecule is any molecule containing both carbon and hydrogen. Inorganic molecules do not include carbon and hydrogen together in a molecule.

An organism is usually formed by enormous number of **micro** and **macro molecules** of hundreds of different types. Some most important and abundant organic molecules in organisms are glucose, amino acids, fatty acids, glycerol, nucleotides like ATP, ADP, AMP etc.

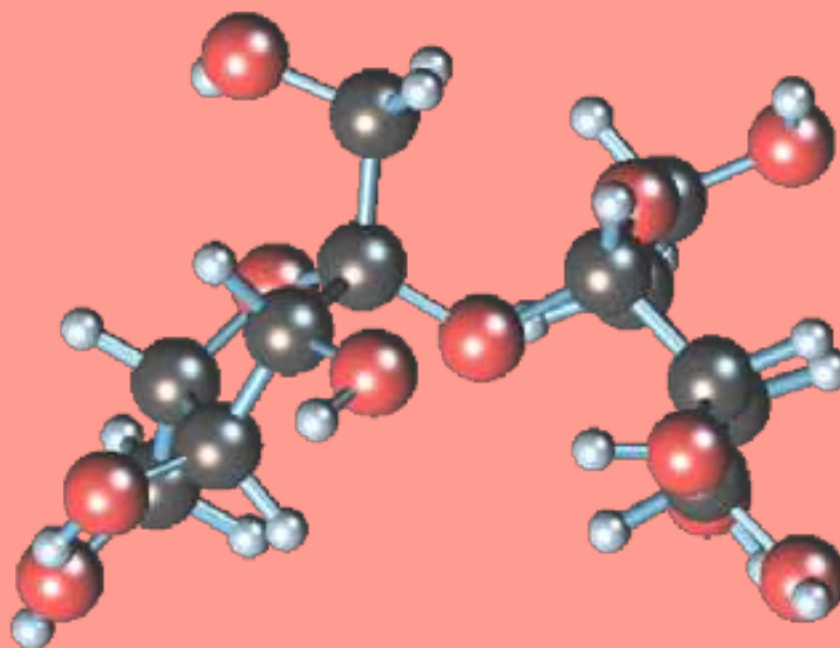

*Animation 11.8 : Molecular Level
Source & Credit: answers*

Organelles & Cell

Different and enormous number of micromolecules and macromolecules arrange themselves in a particular way to form cells and their organelles. In case of simple organisms like bacteria and most protists, the entire organism consists of a single cell. In most fungi, plants and animals, the organism may consist of up to trillions of cells.

Numerous sub-cellular structures like mitochondria, Golgi-complex, endoplasmic reticulum, ribosomes etc have been studied for their structure and function. It has become clear that functions of the cells are accomplished by these specialised structures comparable to the organs of the body. These structures are called **organelles**.

The arrangement of the organelles speaks of the division of labour within the cell. The prokaryotes have only a limited number and type of organelles in their cytoplasm. Eukaryotes are rich in number and kinds of membranous organelles. A cell membrane is however present in all cells whether prokaryotic or eukaryotic.



Tissue Level

In multicellular animals and plants, groups of similar cells are organized into loose sheets or bundles performing similar functions; these are called tissues. Each tissue has a particular function in the life of the organism e.g. muscle tissue, glandular tissue, xylem tissue, phloem tissue etc. They are specialized for contraction (movement), secretion, conducting water and for translocation of sugar, proteins etc.

Orga. & System

Different tissues having related functions, assemble together in a structure to carry out its function with great efficiency. Such structures are called organs and they are specialized to perform particular functions. For example stomach which is an organ has a function of food digestion (protein part), has a secretory epithelium which secretes the gastric juice, and a muscular tissue (smooth) for contracting the walls of the stomach and mixing the food with the enzyme thoroughly and moving the food to the posterior end. The formation of organs also has a selective value because this leads to an efficient accomplishment of their functions both qualitatively and quantitatively. In animals

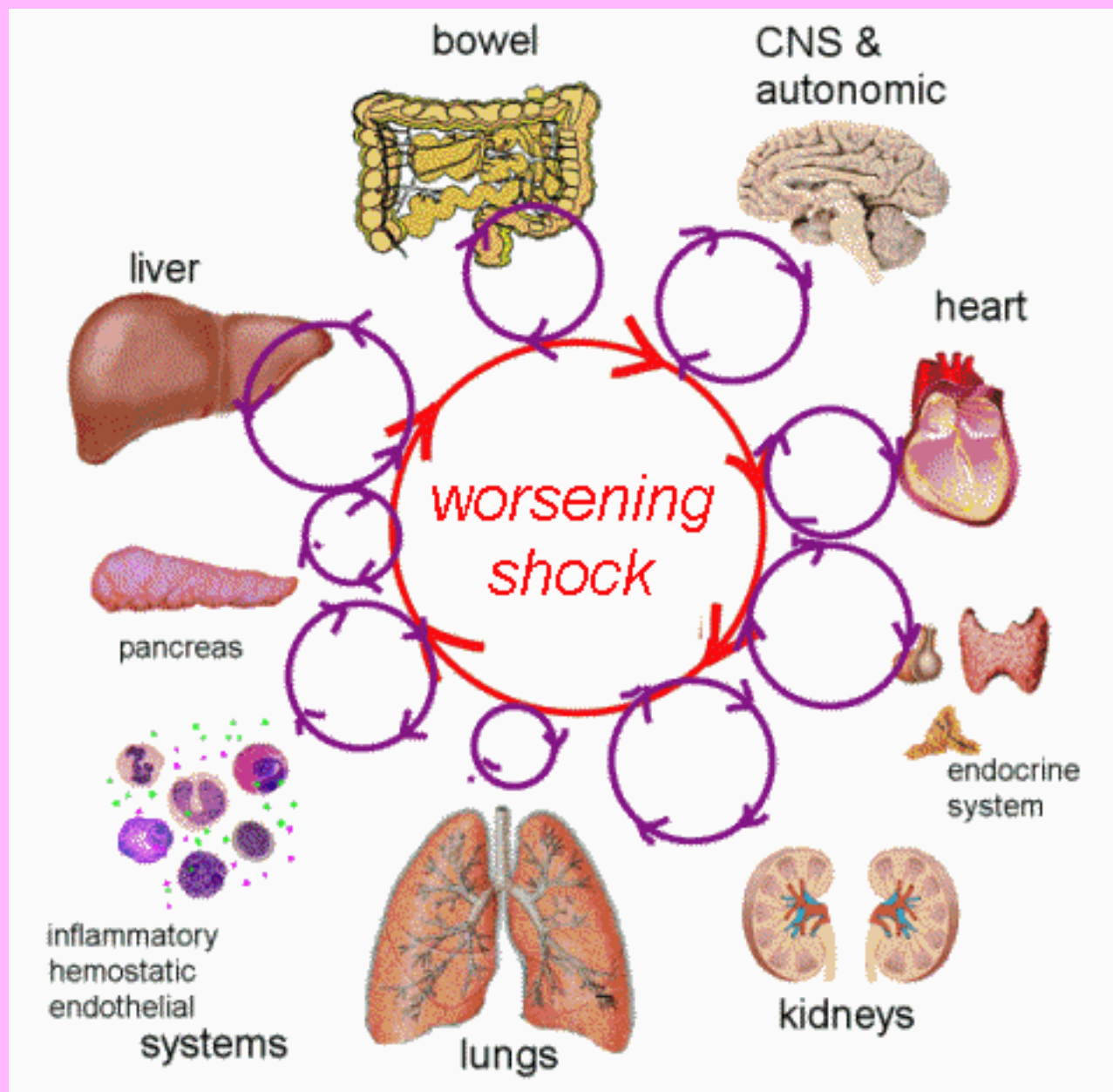

Animation 11.10: Cell Organelles
Source & Credit: answers

organ formation is far more complex and defined. Organs are part of organ systems where total functions involved in one process or phenomenon are carried out.

The organ level of organization is much less definite in plants than it is in animals. At the most, we might distinguish roots, stems, leaves and reproductive structures. Clear cut functions, the distinguishing features, can be assigned to each of these structures. Roots are involved in anchoring the plant, storage of food and procuring water and minerals. The shoot supports the entire plant while the leaves are primary organs for food manufacture. Flowers or other reproductive structures are involved in producing the next generation (reproduction).

The complexity of the organ systems of animals is associated with a far greater range of functions and activities than is found in plants.

I. Individual (Whole Organism)

Various organs in plants and various organ systems in animals are assembled together to form an individual - the whole organism. The whole organism has its individuality as far as its characteristics are concerned. It is different from other members of the same species in certain respects. The various functions, processes, activities of an organism are coordinated. In an animal all the systems work in coordination with each other. For instance if a man is engaged in continuous and hard exercise, not only his muscles are working but there is an increase in the rate of respiration and heart beat to supply the muscles with increased oxygen and food which they need for continuous exercise. In animals the coordination is achieved by means of nervous system and endocrine system, whereas in plants only long term regulation of activities is brought about by hormones.

Organism works as a whole and it interacts and responds to the environmental changes as a whole.

Population.

A population is a group of living organisms of the same species located in the same place at the same time. Examples are the number of rats in a field of rice, the number of students in your biology class, or human population in a city.

Population is a higher level of biological organization than organism (whole) because here a group of organisms of the same species is involved. This level of organization has its own attributes which come into being by living together of a group of organisms of the same species.

Some of these attributes are gene frequency, gene flow, age distribution, population density, population pressure etc. All these are new parameters which have appeared due to population of an organism. You will study them in detail in population ecology.

Community

Populations of different species (plants and animals) living in the same habitat form a community. Communities are dynamic collections of organisms, in which one population may increase and others may decrease due to fluctuation in abiotic factors. Some communities are complex and well interrelated, other communities may be simple. In a simple community any change can have drastic and long lasting effects.

The foregoing account makes it clear that an organism can be studied at different levels of organization. It can be studied at subatomic, atomic, molecular, macromolecular, organelle, cell, tissue, organ and organ system level. We can also look at it as an individual, as a part of population of similar individuals, as a part of a community that includes other populations and a part of community of an ecosystem which includes abiotic factors as well as living organisms, Fig. 1.2.

The organisms, interaction can take many shapes. It may be predation, parasitism, commensalism, mutualism and competition.

Living World in Space

Living world of today is enormous in size. It has been reproducing and evolving since the time of its origin on this planet. Today almost all parts of the world abounds in living organisms. The distribution of organisms in space can be studied through biomes.

A **biome** is a large regional community primarily determined by climate. It has been found that the major type of plant determines the other kind of plants and animals. These biomes have, therefore, been named after the type of major plants or major feature of the ecosystem. The major biomes of the world you will study in the chapter of ecology.

LIVING WORLD IN TIME

Since the time of origin of life on this planet, various organisms were evolved and dominated this planet during various periods of geological time chart. This has been found by the evidence obtained from the discovery and study of fossils which allows biologists to place organisms in a time sequence. As geological time passes and new layers of sediments are laid down, the older organisms should be in deeper layer, provided the sequence of the layers has not been disturbed.

In addition it is possible to date/age rocks by comparing the amounts of certain radioactive isotopes they contain. The older sediment layers have less of these specific radioactive isotopes than the younger layers. A comparison of the layers gives an indication of the relative age of the fossils found in the rocks. Therefore, the fossils found in the same layer must have been alive during the same geological period.

You can have an idea about the temporal distribution of various forms of life both plants and animals in the various geological periods (fig.1.3).

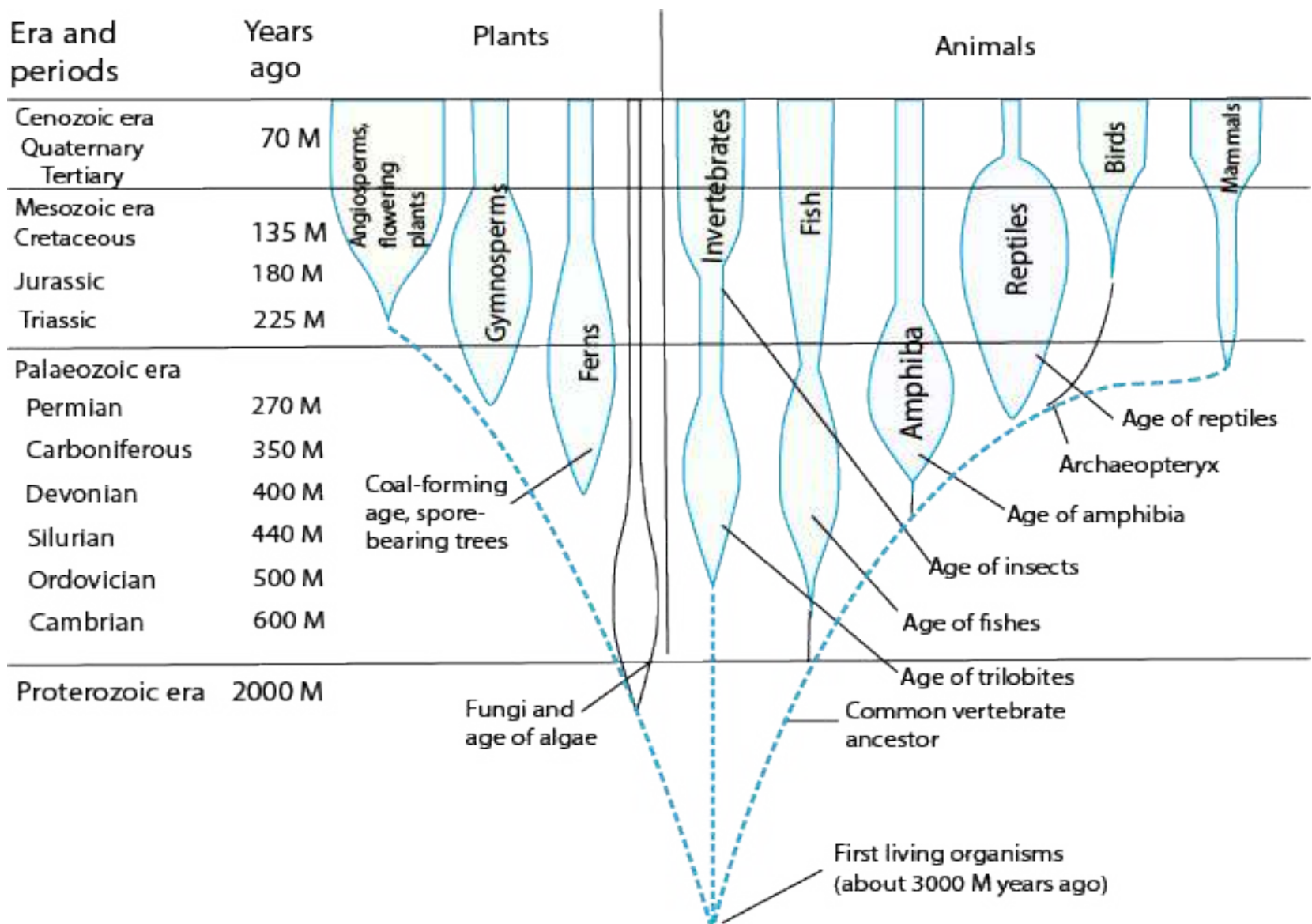

Fig 1.3. Fossil record of plants and animals shown in a geological time chart

Phyletic Lineage

When we look at the biodiversity (the number and variety of species in a place), we find that there are nearly 2,500,000 species of organisms, currently known to science. More than half of these are insects (53.1%) and another 17.6 % are vascular plants. Animals other than insects are 19.9 % (species) and 9.4 % are fungi, algae, protozoa, and various prokaryotes.

This list is far from being complete. Various careful estimates put the total number of species between 5 and 30 millions. Out of these only 2.5 million species have been identified so far.

The life today has come into existence through Phyletic lineages or evolving populations of the organisms living in the remote past. Evolutionary change often produces new species and then increases biodiversity. A phyletic lineage is an unbroken series of species arranged in ancestor to descendant sequence with each later species having evolved from one that immediately preceded it. If we had a complete record of the history of life on this planet, every lineage would extend back in time to the common origin of all early life. We lack that record because many soft bodied organisms of the past had not left their preserved record as fossils.

Biological Method

Science is a systematized knowledge. Like other sciences, biological sciences also have a set methodology. It is based on experimental inquiry. It always begins with chance observation. Observations are made with five senses viz, vision, hearing, smell, taste and touch, depending upon their functional ability. Observations can both be qualitative and quantitative. Quantitative observations have accuracy over qualitative as in the former variables are measurable and are recorded in terms of numbers. An observer organizes observations into data form and gives a statement as per experience and background knowledge of the event. This statement is the **hypothesis**, which is tentative explanation of observations.

At this stage you should look at the ways of devising hypothesis. There are two ways of formulating hypothesis. A hypothesis can be the result of deductive reasoning or it can be the consequence of inductive reasoning.

Deductive reasoning moves from the general to the specific. It involves drawing specific conclusion from some general principle/assumptions. Deductive logic of “if then” is frequently used to frame testable hypothesis. For example, if we accept that all birds have wings (premise #1), and that sparrows are birds (premise # 2), then we conclude that sparrows have wings. If all green plants

require sunlight for photosynthesis, then any green plant when placed in dark would not synthesize glucose, the end product of photosynthesis. The other way of reasoning used in the formulation of hypothesis is **inductive reasoning** which is reasoning from the specific to the general. It begins with specific observations, and leads to the formation of general principle. For instance, if we know that sparrows have wings and are birds, and we know that eagle, parrot, hawk, crow are birds, then we induce (draw conclusion) that all birds have wings. The science also, therefore, uses inductive methods to generalize from specific events.

In fact sometimes scientists also use other ways to form a hypothesis, which may include (1) intuition or imagination (2) esthetic preference (3) religious or philosophical ideas (4) comparison and analogy with other processes (5) discovery of one thing while looking for some other thing. These ways can also sometimes form basis for scientific hypothesis. Hypotheses as you already know, are subjected to rigorous testing.

Repeated exposure of a hypothesis to possible falsification increases scientist's confidence in the hypothesis when it is not falsified. Any hypothesis that is tested again and again without ever being falsified is considered well supported and is generally accepted. This may be used as the basis for formulating further hypothesis. So there is soon a series of hypotheses supported by the results of many tests which is then called a theory. A good theory is predictive and has explanatory power. One of the most important features of a good theory is that it may suggest new and different hypotheses. A theory of this kind is called productive.

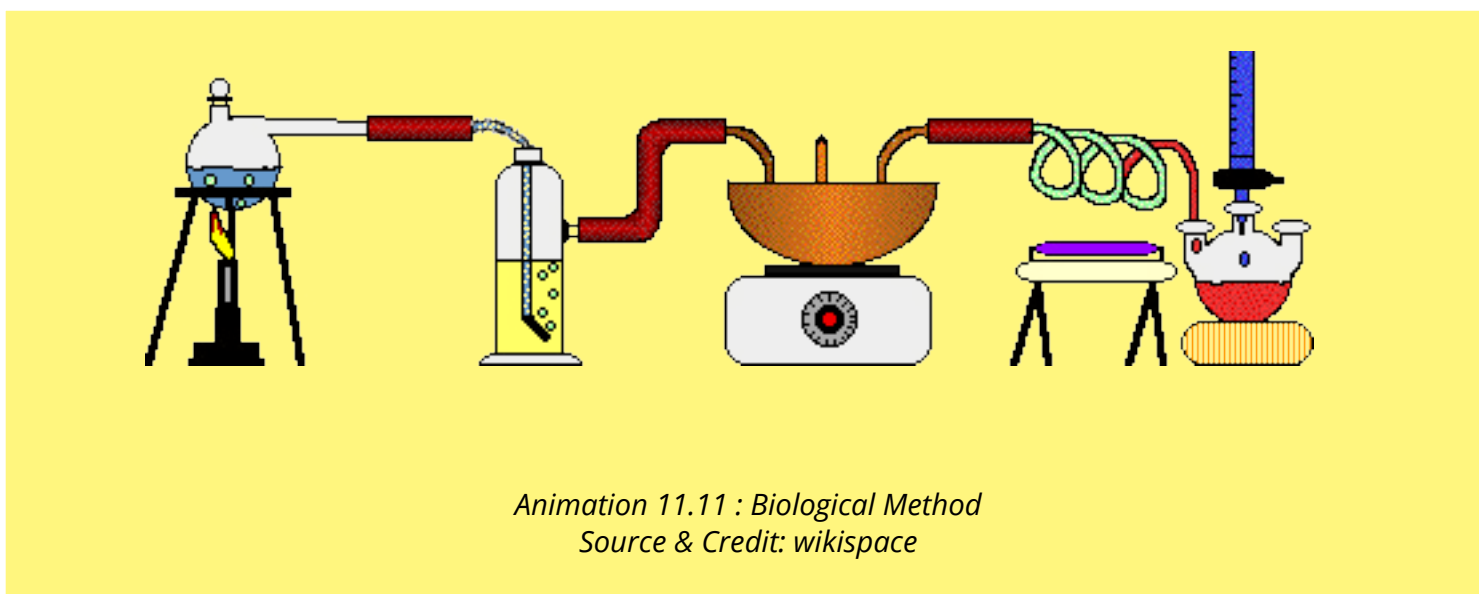

However even in the case of productive theory the testing goes on. In fact many scientists take it as a challenge and exert even greater efforts to disprove the theory. If a theory survives this skeptical approach and continues to be supported by experimental evidence, it becomes a scientific law. A **scientific law** is a uniform or constant fact of nature, it is virtually an irrefutable theory. Biology is short in laws because of elusive nature of life.

Examples of biological laws are Hardy-Weinberg law and Mendel's laws of inheritance. You will learn about them in later chapters. You can see that laws are even more general than theories and afford answers to even more complex questions, therefore there are relatively a few laws in biology.

BIOLOGY AND THE SERVICE OF MANKIND

The science of biology has been helping mankind in many ways in increasing food production; in combating diseases and in protecting and conserving environment. Biological advances in the field of food and health have resulted in high standard of living.

Plant production has been tremendously increased by improving existing varieties and developing new high-yield and disease - resistant varieties of plants and animals used as food.

Plant and animal breeders have developed, through selective breeding, using the principles of genetics, new better varieties of wheat, rice, corn, chicken, cow and sheep. Poultry breeders have developed broilers for getting quick and cheap white meat. Genes for disease resistance and other desirable characters are introduced into plant, using the techniques of **genetic engineering**. Such **transgenic plants** (plants having foreign DNA incorporated into their cells) can be propagated by **cloning** (production of genetically identical copies of organisms/cells by asexual reproduction) using special techniques such as **tissue culture techniques** etc. Plant pathogenic fungi and insect pests of crops which weaken the plants and reduce the yield had traditionally been controlled by using chemical fungicides and insecticides (pesticides). Use of these chemicals poses toxicity problems for human beings as well as environmental pollution. Moreover, there are chances of insects becoming resistant to the effect of these chemicals. **Biological control** (control by some living organisms) eliminates all such hazards. In biological control, pests are destroyed by using some living organisms that compete with or even eat them up. An aphid that attacks walnut tree is being controlled biologically by a wasp that parasitizes this aphid.

Even some bacteria are being used as bio-pesticides. Effective control of a particular disastrous disease, or all the common diseases of a plant can be achieved by using all relevant, appropriate methods of disease control. Such an approach of disease control is called “**integrated disease management**”.

Soil is a complex medium. It is almost impossible to conduct experiments on nutrient requirements of plants by growing them in soil. **Hydroponic culture technique** is used to test whether a certain nutrient is essential for plant or not. In this technique the plants are grown in aerated water to which nutrient mineral salts have been added. Hydroponic farming, however, is yet not feasible. Astronauts may use it for growing vegetables.

Different techniques of food preservation have been developed for protecting food from spoilage and for its use and transport over long distance without damaging its quality. One of these is **pasteurization**, developed by Louis Pasteur. It is being widely used for preservation of milk and milk products.

Disease Control

There has been fantastic progress in the area of health and disease control. Three pronged actions are usually taken against various diseases.

1. Preventive measures
2. Vaccination/Immunization
3. Drug treatment/Gene therapy

Preventive measures

The advances in biological sciences have provided us information about the causative agents of the diseases and their mode of transmission. For instance the AIDS (Acquired Immune Deficiency Syndrome) is caused by HIV (human immuno deficiency virus) and it spreads through free sexual contact, through blood transfusion, by using contaminated syringes or surgical instruments etc. Therefore, doctors advise us to take precautions on these fronts so that we do not contract the disease, which is at present incurable. Similarly hepatitis is caused by H.virus which is spread through blood transfusion by using contaminated syringes and surgical instruments etc. In this case also doctors advise us to be careful and avoid the point of contact.

Vaccination / Immunization

Many diseases such as polio, whooping cough, measles, mumps etc can easily be controlled by vaccination or “shots”.

Edward Jenner first developed the technique of vaccination in 1796, cowpox pus is known as vacca (from latin vacca=cow). From this word evolved the present term vaccination and vaccine. You will learn more about vaccination in chapter 6.

Since then, inoculation or vaccination is carried out to make the people immune from viral or bacterial epidemics or, for some diseases the individuals are vaccinated in their early life to make them immune to those diseases.

It is claimed that small pox has been totally eliminated from the world by using this method. Scientists are making continuous efforts to develop vaccine against other diseases. Even vaccine against AIDS is being administered in humans on experimental basis.

Drug treatment / Gene therapy

If a person becomes sick with disease, he is subjected to the action of **antibiotics** which can kill bacteria. The antibiotics are, however, useful in bacterial disease and that only when bacteria have not developed resistance to antibiotics. In cancer, **radiotherapy** and **chemotherapy** are also used. In radiotherapy, the cancerous part is exposed to short wave radiations from the radioactive material repeatedly at regular intervals. In Pakistan there are several centres which are carrying out radiotherapy to control cancer. Chemotherapy consists of administering certain anticancer chemicals to the patients at regular intervals. These chemicals may kill both cancerous and normal cells.

Recently a new technique has been developed to repair defective genes. This consists of isolating the normal gene and inserting it into the host through bone marrow cells. This is called **gene therapy**.

Combating disease utilizing all methods as and when required and ensuring a participation of community in this programme is known as **integrated disease management**. This requires awareness of the community about the severity of the problem, its causes and its remedies. This is a very effective programme for elimination and control of dangerous diseases from the human society.

Besides its contribution to food production and health of man, biology has discovered a number of means and developed technologies for the welfare of mankind as for example cloning, protection and conservation of environment etc.

Cloning: Cloning is a technology for achieving **eugenic aims**. A **clone** is defined as a cell or individual and all its asexually produced offspring. All members of a clone are genetically identical except when a mutation occurs.

Generally no normal animal reproduces naturally by cloning. Several insects and many plants do, in some circumstances whereas few do so regularly.

In 1997 scientists in Scotland succeeded in cloning a sheep. Other mammalian species (mice and cows) have since been cloned. In this procedure the nucleus from a fertilized egg is removed and a nucleus from a cell of a fully developed individual is inserted in its place. The altered zygote is then implanted in a suitable womb where it completes its development. The new individual formed in this way is a genetically identical clone of the individual whose nucleus was used. Thus cloning could make multiple copies of a desired genotype.

Another type of cloning is the division of a single egg or early embryo into one or more separate embryos. This is the same process that normally creates identical twins. Offspring from this type of cloning are genetically identical but carry chromosomes from each of the two parents. This type of cloning has already been used to produce genetically identical cattle and other farm animals.

Man is likely to adopt cloning techniques for commercial production of valuable animals of known pedigree such as horses etc.

At some places scientists are making attempts to clone human embryo which they believe can serve as transplant donor. There is a lot of controversy on this issue as to whether human cloning should be attempted or not.

PROTECTION AND CONSERVATION OF ENVIRONMENT

Industrialization has helped mankind to raise the standard of living. It has at the same time destroyed our environment. Tons of industrial waste, and effluents in solid, liquid or gas form are being injected into the environment by the industries. These effluents frequently contain sizeable amount of certain very toxic even carcinogenic materials. Heavy metals like lead from automobiles, chromium from tanneries, are playing havoc to human health. Environmental pollution has reached alarming level in some countries.

This problem, therefore, needs to be addressed or else it would soon be out of control in which case the biocomponents of the world ecosystem would suffer irreparable loss and this environment would no longer support life on this planet.

Biology has helped mankind in attracting attention to this problem and the biologists are striving to find the solution to set this environment right wherever it has deteriorated: Biologists have already asked for the treatment of industrial effluents to be made obligatory. Several ways of bioremediation (removal or degradation of environmental pollutants or toxic materials by living organisms) are also under investigation. For example algae have been found to reduce pollution of heavy metals by bioabsorption.

Biologists are also working out the list of **endangered species** of plants and animals which if not protected would soon be extinct. They have, therefore, stressed the needs for their protection.

The environmental pollution is a national problem in Pakistan. Our rivers, canals are highly polluted with the mixing of city sewage and industrial wastes. The life in fresh water of Pakistan is towards decline. Fish populations have been most adversely affected. We need to take protective measures as early as possible. In cities, particularly the exhaust from automobiles is enormously adding lead into the atmosphere. There is then a need for lead free petrol to reduce the pollution.

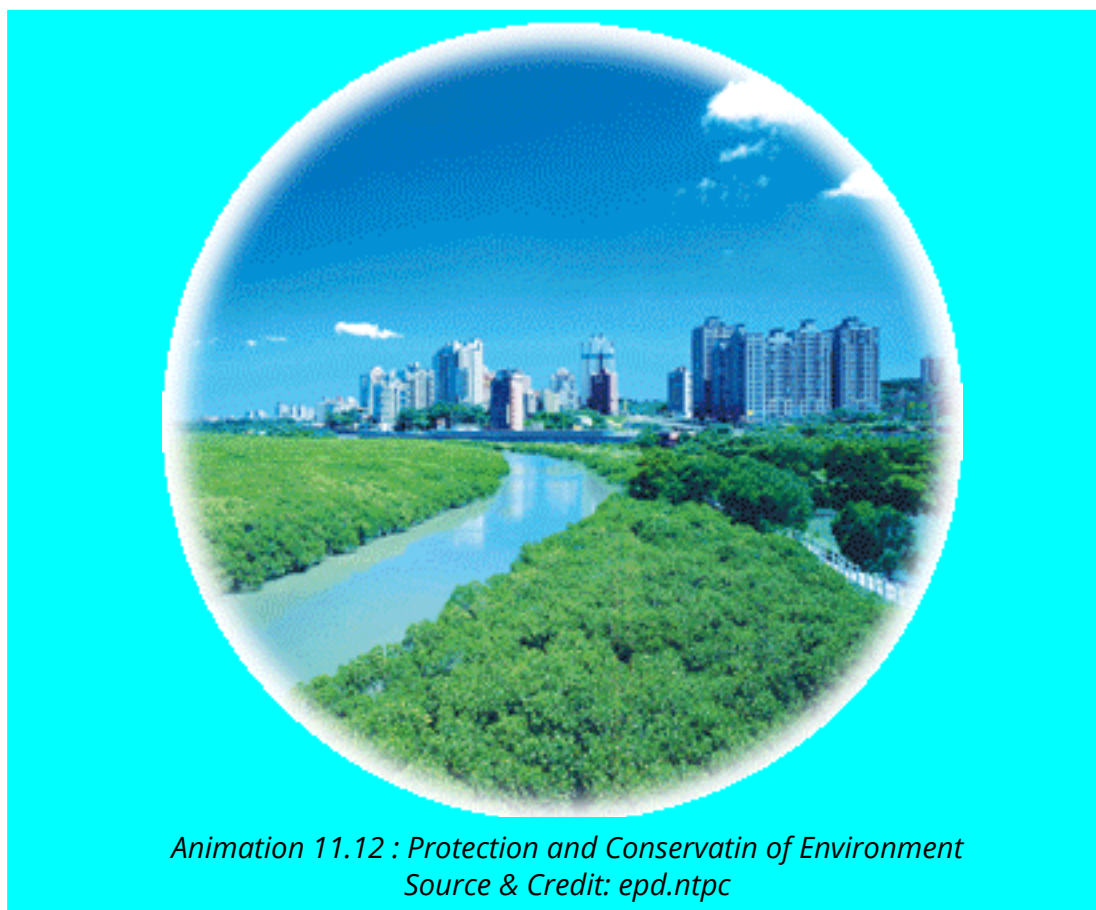

*Animation 11.12 : Protection and Conservatin of Environment
Source & Credit: epd.ntpc*

Exercise

Q.1. Fill in the blanks

- (i) _____ is the study of organisms in relation to their environment.
- (ii) The study of organisms living in fresh water bodies like rivers, lakes etc is called _____.
- (iii) _____ is the branch of biology which deals with the study of social behaviour and communal life of human beings.
- (iv) In the _____ body only six bio-elements accounts for 99% of the total mass.
- (v) All living things and nonliving things are formed of simple units called _____.
- (vi) Various organs in plants and various organ systems in animals are assembled together to form an _____.
- (vii) A _____ is a group of organisms of the same species located in the same place at the same time.
- (viii) A _____ is based upon observations.
- (ix) A hypothesis is a result of deductive reasoning or it can be the consequence of _____ reasoning.

Q.2. Write whether the statement is 'true' or 'false' and write the correct statement if it is false.

- (i) Penicillin was discovered by Edward Jenner from a fungus Penicillium.
- (ii) Many diseases such as polio, whooping cough, measles, mumps etc can be controlled by antibiotics.

- (iii) Exposure to the small pox virus allows the body to develop immunity against cowpox virus.
- (iv) AIDS is caused by HIV and it spreads through sexual contacts, blood transfusion, by contaminated syringe or surgical instruments.

Q.4. Short questions.

- (i) What do you mean by hypothesis?
- (ii) How does law differ from theory?
- (iii) What is deductive reasoning ?
- (iv) Define vaccination.
- (v) Write a short note on cloning.

Q.5. Extensive question.

- (i) Define the following branches of biology:
Molecular Biology, Microbiology, Marine Biology, Biotechnology
- (ii) Discuss briefly phyletic lineage in biological organization.
- (iii) Write notes on the following:
 - (a) Living world in space and time
 - (b) Population (c) Community
- (iv) Explain the biological method for solving a biological problem. How do deductive and inductive reasoning play an important role in it?
- (v) What is the role of the study of Biology in the welfare of mankind?

CHAPTER

2

Biological Molecules

Animation 2.1 : Molecular Biology
Source & Credit: godandscience

INTRODUCTION TO BIOCHEMISTRY

Biochemistry is a branch of Biology, which deals with the study of chemical components and the chemical processes in living organisms. A basic knowledge of Biochemistry is essential for understanding anatomy and physiology, because all of the structures of an organism have biochemical organization. For example, photosynthesis, respiration, digestion, muscle contraction can all be described in biochemical terms.

All living things are made of certain chemical compounds, which are generally classified as organic and inorganic. Most important organic compounds in living organisms are carbohydrates, proteins, lipids and nucleic acids. Among inorganic substances are water, carbon dioxide, acids, bases, and salts.

Typically an animal and a bacterial cell consists of chemicals as shown in the following table.

Table 2.1 Chemical composition of a Bacterial and a Mammalian cell.

Chemical components	% total cell weight	
	Bacterial cell	Mammalian cell
1 Water	70	17
2 Proteins	15	18
3 Carbohydrates	3	4
4 Lipids	2	3
5 DNA	1	0.25
6 RNA	6	1.1
7 Other organic molecules (Enzymes, hormones, metabolites)	2	2
8 Inorganic ions (Na ⁺ , K ⁺ , Ca ⁺⁺ , Mg ⁺⁺ Cl ⁻ , SO ₄ ⁻ etc)	1	1

The survival of an organism depends upon its ability to take some chemicals from its environment and use them to make chemicals of its living matter. For this reason, cells of every organism are

constantly taking in new substances and changing them chemically in various ways i.e. building new cellular materials and obtaining energy for their needs. Life of an organism depends upon the ceaseless chemical activities in its cells. This chemical activity is maintained with a high degree of organization. All the chemical reactions taking place within a cell are collectively called metabolism. Metabolic processes are characterized as anabolism and catabolism. Those reactions in which simpler substances are combined to form complex substances are called anabolic reactions. Anabolic reactions need energy. Energy is released by the break down of complex molecules into simpler ones, such reactions are called catabolic reactions. Anabolic and catabolic reactions go hand in hand in the living cells. Complex molecules are broken down and the resulting smaller molecules are reused to form new complex molecules. Interconversions of carbohydrates, proteins, and lipids that occur continuously in living cells are examples of co-ordinated catabolic and anabolic activities.

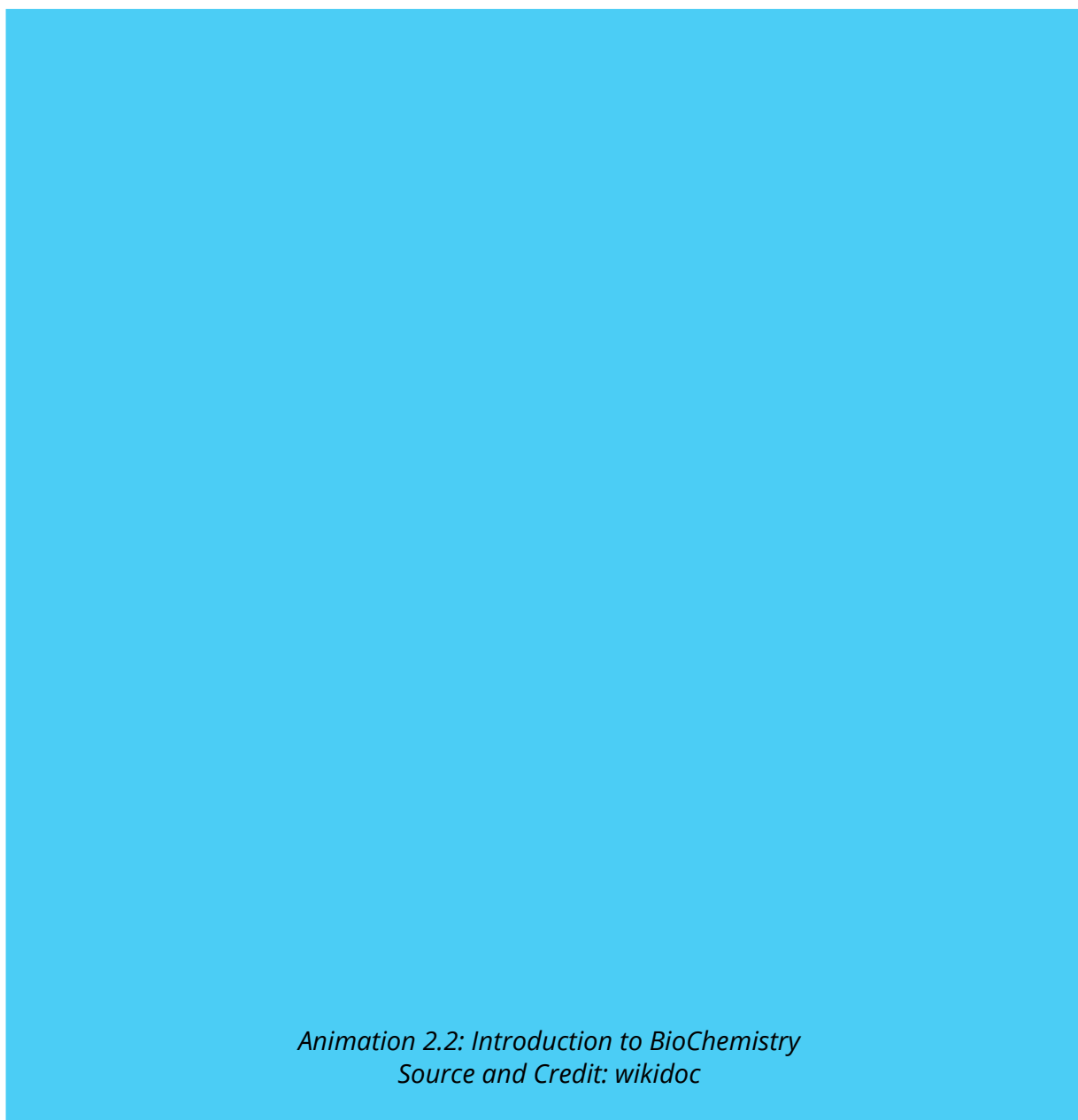

*Animation 2.2: Introduction to BioChemistry
Source and Credit: wikidoc*

IMPORTANCE OF CARBON

Carbon is the basic element of organic compounds. Due to its unique properties, carbon occupies the central position in the skeleton of life.

Carbon is tetravalent. It can react with many other known elements forming covalent bonds.

When a carbon atom combines with four atoms or radicals, the four bonds are arranged symmetrically in a tetrahedron, and result to give a stable configuration. The stability associated with the tetravalency of carbon atoms makes it a favourable element for the synthesis of complicated cellular structures. Carbon atoms can also combine mutually forming stable, branched or unbranched chains or rings. This ability of carbon is responsible for the vast variety of organic compounds. C - C bonds form a skeleton of organic molecules as shown in Fig. 2.1

Covalent bonds result when two or more atoms complete their electron shells by sharing electrons. When an electron pair is shared between two atoms, a single covalent bond results. An example is the bond between two hydrogen atoms to form a hydrogen molecule. Covalent bond stores large amount of energy.

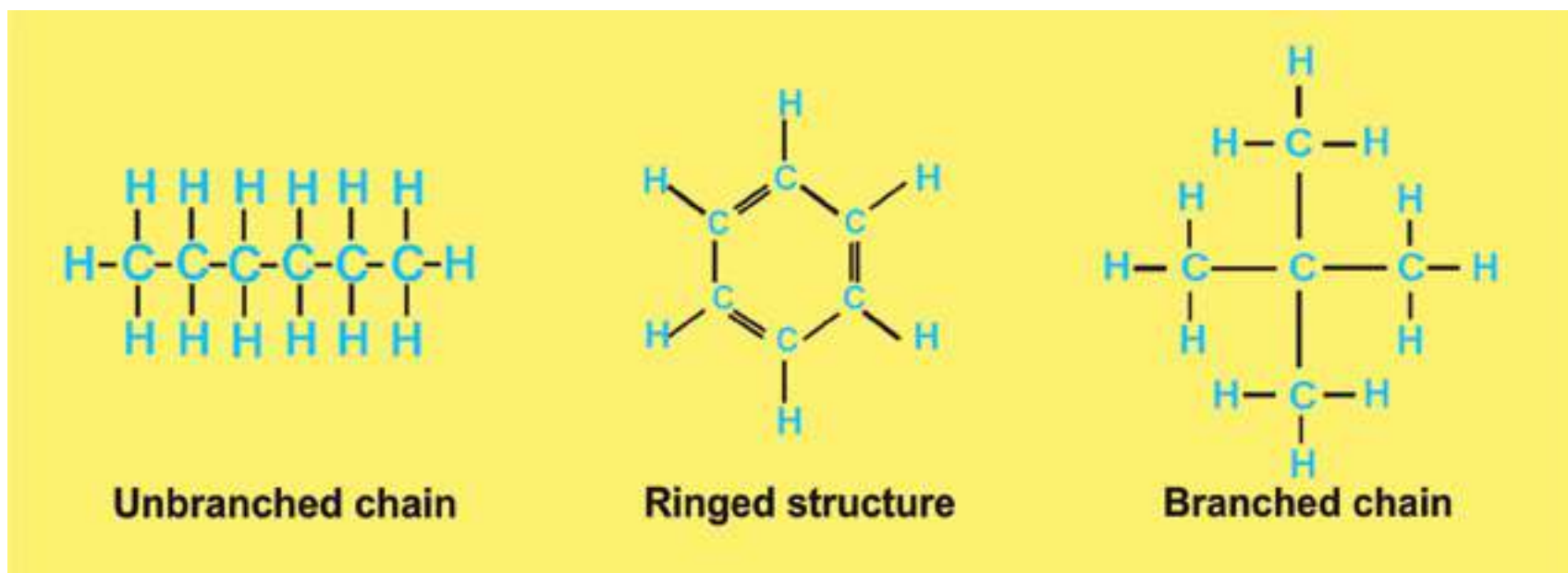
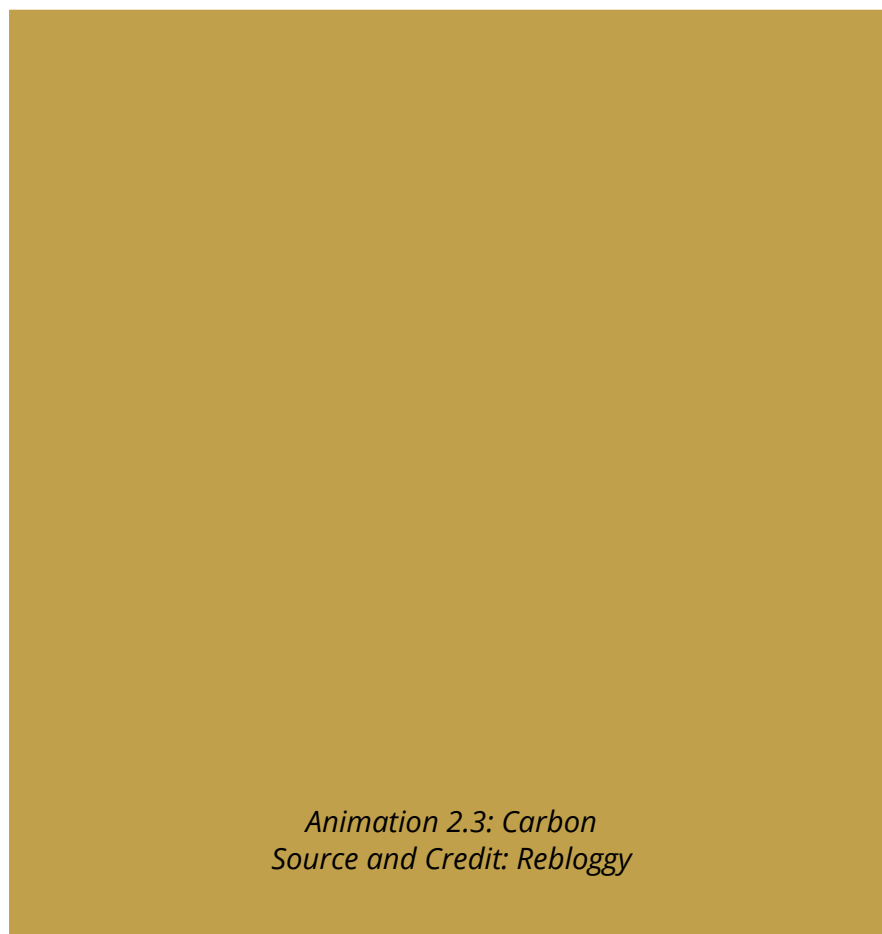

Fig. 2.1. : Unbranched and branched chains, and ring structure form and by C-C bonds.

Carbon combines commonly with H, O, N, P and S. Combinations with these and other elements contribute to the large variety of organic compounds. Carbon and hydrogen bond (C-H bond) is the potential source of chemical energy for cellular activities. Carbon-oxygen association in glycosidic linkages provides stability to the complex carbohydrate molecules. Carbon combines with nitrogen in amino acid linkages to form peptide bonds and forms proteins which are very important due to their diversity in structure and functions.

Large organic molecules (macromolecules) such as cellulose, fats, proteins, etc. are generally insoluble in water, hence they form structures of cells. They also serve as storage for smaller molecules like glucose, which in turn are responsible for providing energy to the body.

Small molecules, such as glucose, amino acids, fatty acids etc. serve either as a source of energy, or as subunits to build macromolecules. Some small molecules are so unstable that they are immediately broken down to release energy e.g. ATP. Such substances serve as immediate source of energy for cellular metabolism.



IMPORTANCE OF WATER

Water is the medium of life. It is the most abundant compound in all organisms. It varies from 65 to 89 percent in different organisms. Human tissues contain about 20 per cent water in bone cells and 85 percent in brain cells. Almost all reactions of a cell occur in the presence of water. It also takes part in many biochemical reactions such as hydrolysis of macromolecules. It is also used as a raw material in photosynthesis.

Solvent properties

Due to its polarity, water is an excellent solvent for polar substances. Ionic substances when dissolved in water, dissociate into positive and negative ions. Non-ionic substances having charged groups in their molecules are dispersed in water. When in solution, ions and molecules move randomly and are in a more favourable state to react with other molecules and ions. It is because of this property of water that almost all reactions in cells occur in aqueous media. In cells all chemical reactions are catalyzed by enzymes which work in aqueous environment. Nonpolar organic molecules, such as fats, are insoluble in water and help to maintain membranes which make compartments in the cell.

Heat capacity

Water has great ability of absorbing heat with minimum of change in its own temperature. The specific heat capacity of water - the number of calories required to raise the temperature of 1g of water from 15 to 16°C is 1.0. This is because much of the energy is used to break hydrogen bonds. Water thus works as temperature stabilizer for organisms in the environment and hence protects living material against sudden thermal changes.

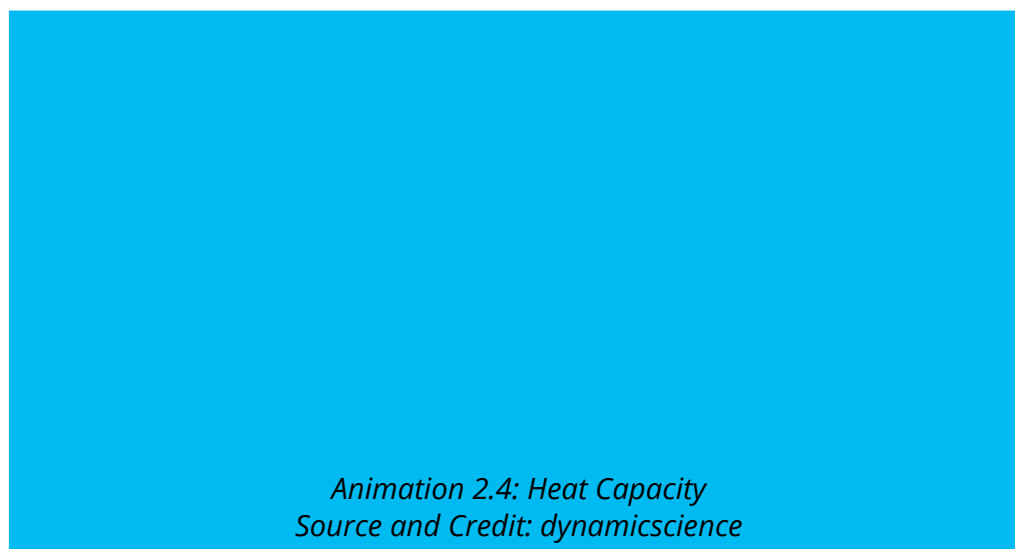

Heat of vaporization.

Water absorbs much heat as it changes from liquid to gas. Heat of vaporization is expressed as calories absorbed per gram vaporized. The specific heat of vaporization of water is 574 Kcal/kg, which plays an important role in the regulation of heat produced by oxidation. It also provides cooling effect to plants when water is transpired, or to animals when water is perspired. Evaporation of only two ml out of one liter of water, lowers the temperature of the remaining 998 ml by 1°C.

Ionization of water

The water molecules ionize to form H⁺ and OH⁻ ions:



This reaction is reversible but an equilibrium is maintained. At 25°C the concentration of each of H⁺ and OH⁻ ions in pure water is about 10⁻⁷ mole/litre. The H⁺ and OH⁻ ions affect, and take part in many of the reactions that occur in cells.

Protection.

Water is effective lubricant that provides protection against damage resulting from friction. For example, tears protect the surface of eye from the rubbing of eyelids, water also forms a fluid cushion around organs that helps to protect them from trauma.

CARBOHYDRATES

Carbohydrates occur abundantly in living organisms. They are found in all organisms and in almost all parts of the cell. Cellulose of wood, cotton and paper, starches present in cereals, root tubers, cane sugar and milk sugar are all examples of carbohydrates. Carbohydrates play both structural and functional roles. Simple carbohydrates are the main source of energy in cells. Some carbohydrates are the main constituents of cell walls in plants and micro-organisms.

The word carbohydrate literally means hydrated carbons. They are composed of carbon, hydrogen and oxygen and the ratio of hydrogen and oxygen is the same as in water. Their general formula is C_x(H₂O)_y where (x) is the whole number from three to many thousands whereas y may be the same or different whole number. Chemically, carbohydrates are defined as polyhydroxy aldehydes or ketones, or complex substances which on hydrolysis yield polyhydroxy aldehyde or ketone subunits. (Hydrolysis involves the break down of large molecules into smaller ones utilizing water molecules).

The sources of carbohydrates are green plants. These are the primary products of photosynthesis. Other compounds of plants are produced from carbohydrates by various chemical changes.

Carbohydrates in cell combine with proteins and lipids and the resultant compounds are called glycoproteins and glycolipids, respectively. Glycoproteins and glycolipids have structural role in the extracellular matrix of animals and bacterial cell wall. Both these conjugated molecules are components of biological membranes.

Classification of Carbohydrates

Carbohydrates are also called 'saccharides' (derived from Greek word 'sakcharon' meaning sugar) and are classified into three groups: (i) Monosaccharides (ii) Oligosaccharides, and (iii) Polysaccharides.

Monosaccharides: These are simple sugars. They are sweet in taste, are easily soluble in water, and cannot be hydrolysed into simpler sugars. Chemically they are either polyhydroxy aldehydes or ketones. All carbon atoms in a monosaccharide except one, have a hydroxyl group. The remaining carbon atom is either a part of an aldehyde group or a keto group. The sugar with aldehyde group is called aldo-sugar; and with the keto group as keto-sugar. These are indicated in the case of two trioses sketched below (Fig. 2.2).



Fig. 2.2: Structure of glyceraldehyde, a 3C Sugar (C₃H₆O₃). The aldehyde form is glyceraldehyde, whereas ketonic form is dihydroxyacetone.

In nature monosaccharides with 3 to 7 carbon atoms are found. They are called trioses (3C), tetroses (4C), pentoses (5C), hexoses (6C), and heptoses (7C). They have general formula $(\text{CH}_2\text{O})_n$, where n is the whole number from three to seven thousands.

Two trioses mentioned above are, intermediates in respiration and photosynthesis. Tetroses are rare in nature and occur in some bacteria. Pentoses and hexoses are most common. From the biological point of view the most important hexose is glucose. It is an aldose sugar. Structure of ribose and glucose is given below (Fig. 2.3).

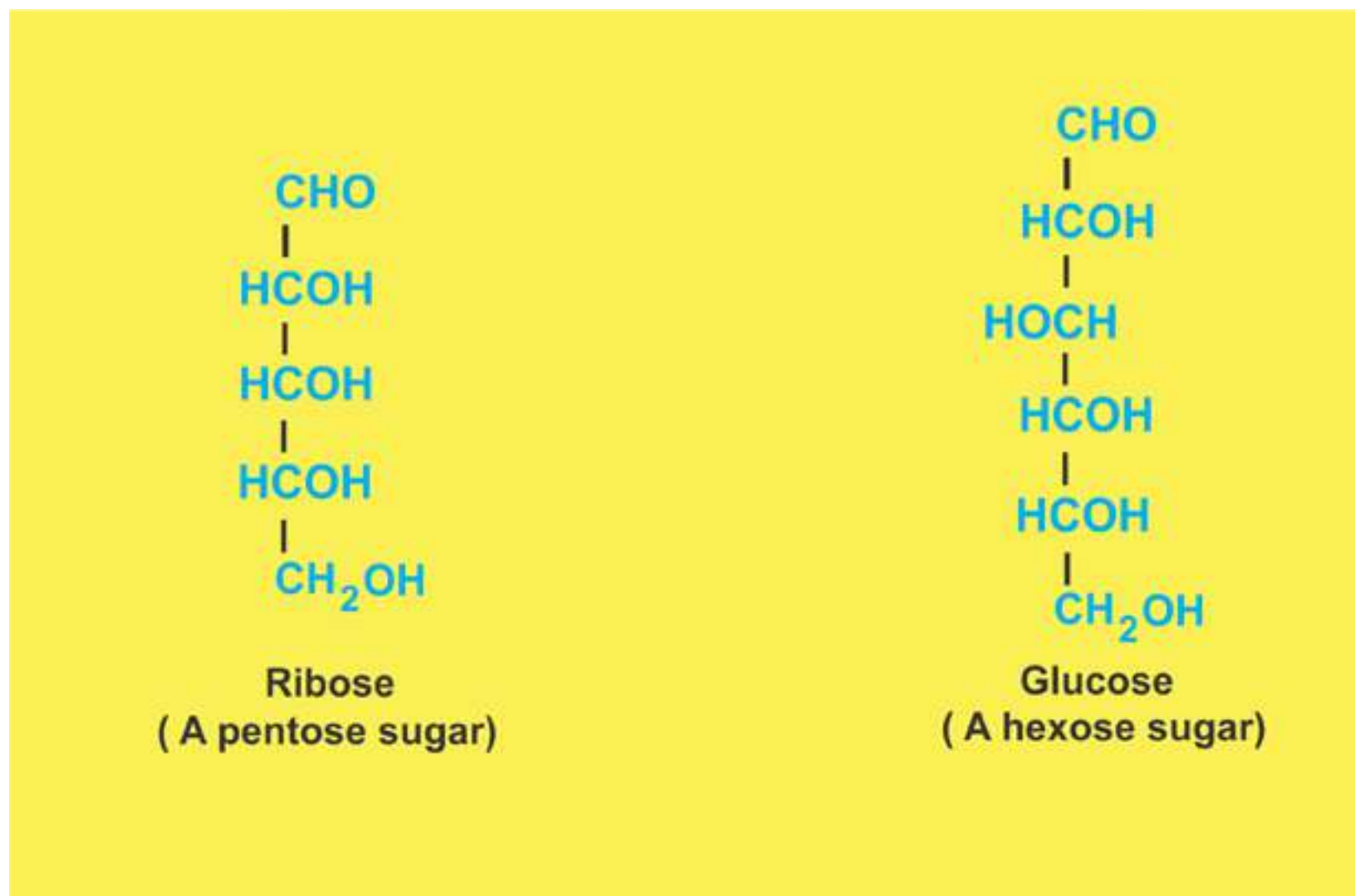

Fig. 2.3 Structure of Ribose and Glucose.

Most of the monosaccharides form a ring structure when in solution. For example ribose will form a five cornered ring known as ribofuranose, whereas glucose will form six cornered ring known as glucopyranose (Fig. 2.4).

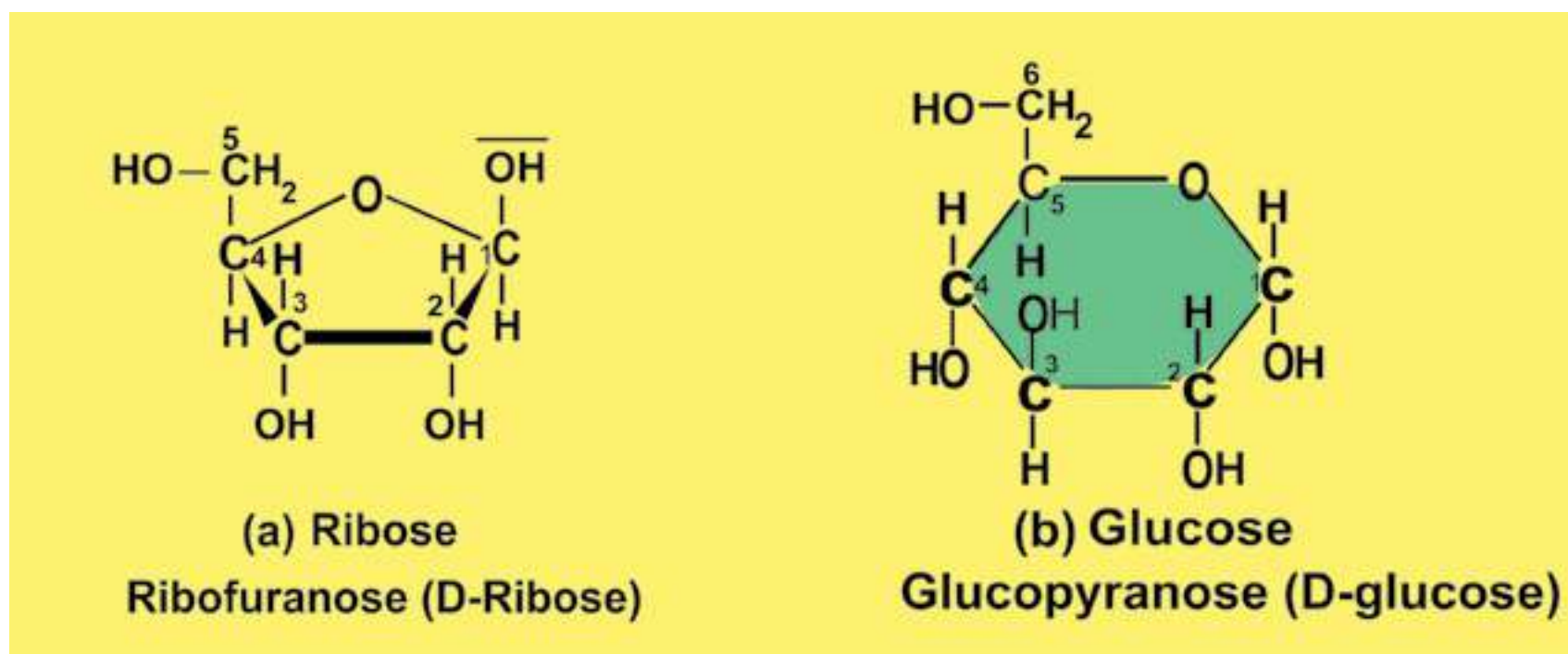
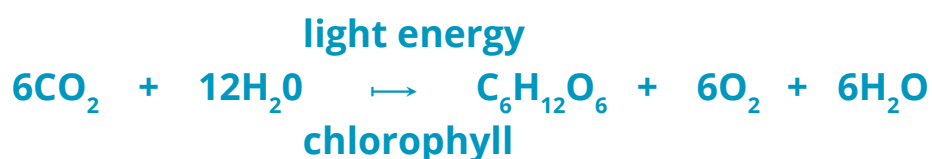

Fig. 2.4 Ribose and glucose form ring shaped structures.

In free state, glucose is present in all fruits, being abundant in grapes, figs, and dates. Our blood normally contains 0.08% glucose. In combined form, it is found in many disaccharides and polysaccharides. Starch, cellulose and glycogen yield glucose on complete hydrolysis. Glucose is naturally produced in green plants which take carbon dioxide from the air and water from the soil to synthesize glucose.



As indicated in the equation, energy is consumed in this process which is provided by sunlight. This is why the process is called Photosynthesis. It is noteworthy that for the synthesis of 10g of glucose 717.6 Kcal of solar energy is used. This energy is stored in the glucose molecules as chemical energy and becomes available in all organisms when it is oxidized in the body.

Oligosaccharides: These are comparatively less sweet in taste, and less soluble in water. On hydrolysis oligosaccharides yield from two to ten monosaccharides. The ones yielding two monosaccharides are known as disaccharides, those yielding three are known as trisaccharides and so on. The covalent bond between two monosaccharides is called **glycosidic bond**.

Physiologically important disaccharides are maltose, sucrose, and lactose (see Fig. 2.5). Most familiar disaccharide is sucrose (cane sugar) which on hydrolysis yields glucose and fructose, both of which are reducing sugars. Its molecular formula is $C_{12}H_{22}O_{11}$. Its structural formula is given in Fig. 2.5.

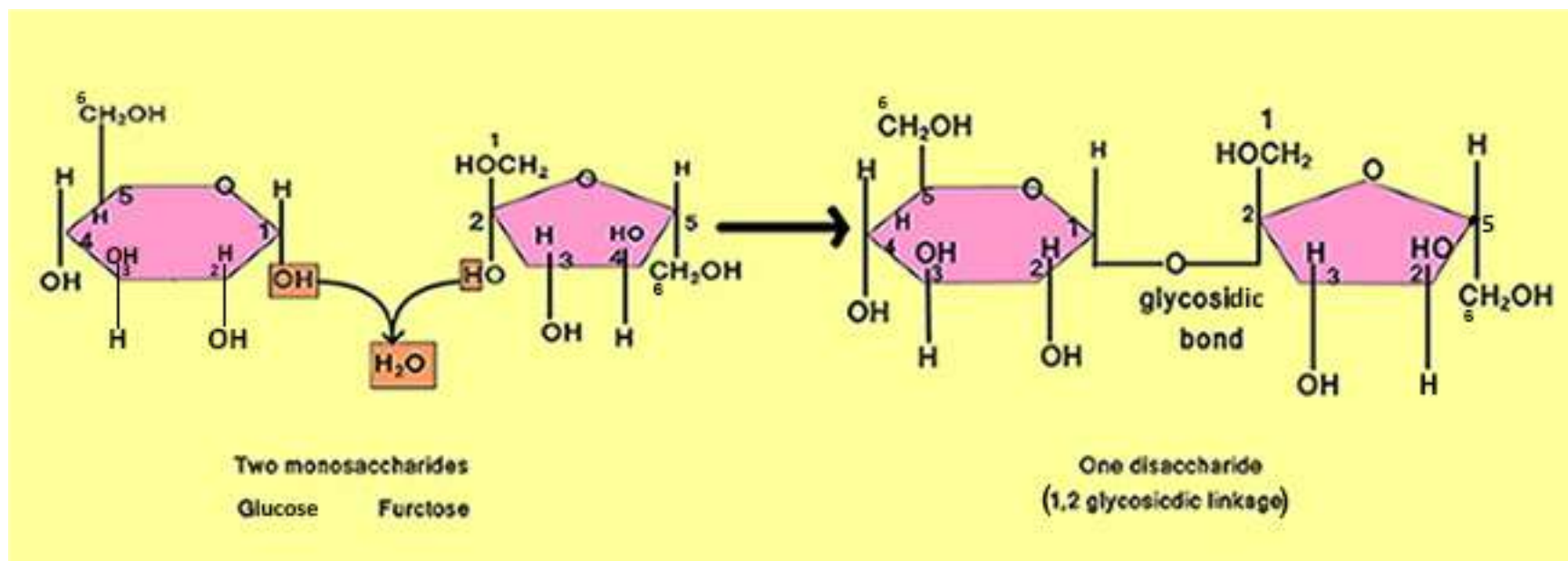
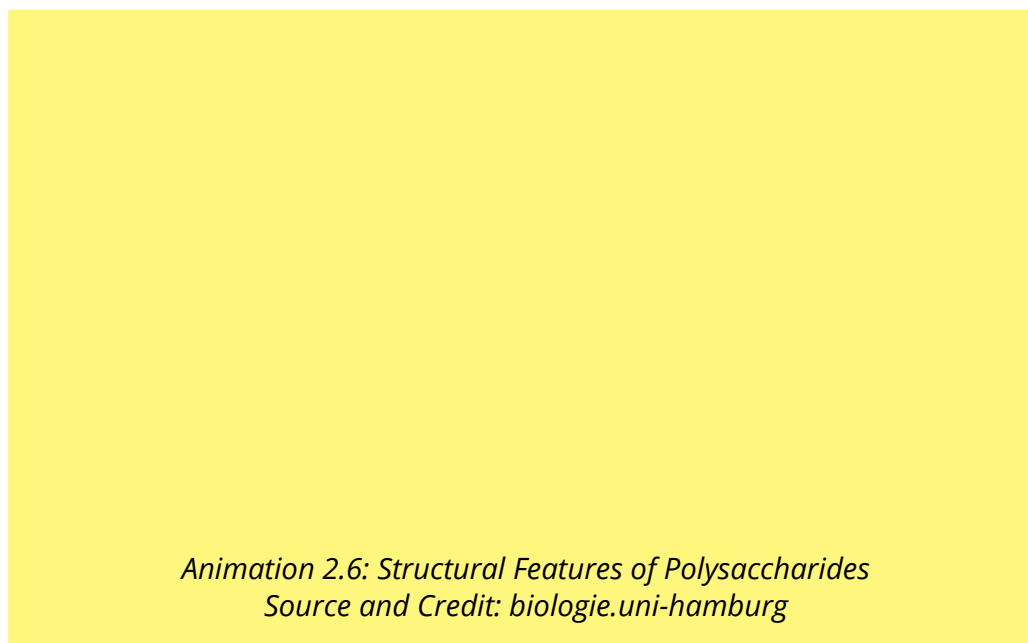

Fig. 2.5 A disaccharide. Note carefully the glycosidic linkage between the two monosaccharides.

Animation 2.5: Carbohydrates
Source and Credit: answers

Polysaccharides: Polysaccharides are the most complex and the most abundant carbohydrates in nature. They are usually branched and tasteless. They are formed by several monosaccharide units linked by glycosidic bonds (Fig. 216). Polysaccharides have high molecular weights and are only sparingly soluble in water. Some biologically important polysaccharides are starch, glycogen, cellulose, dextrans, agar, pectin, and chitin.



Animation 2.6: Structural Features of Polysaccharides
Source and Credit: biologie.uni-hamburg

Starch: It is found in fruits, grains, seeds, and tubers. It is the main source of carbohydrates for animals. On hydrolysis, it yields glucose molecules. Starches are of two types, amylose and amylopectin. Amylose starches have unbranched chains of glucose and are soluble in hot water. Amylopectin starches have branched chains and are insoluble in hot or cold water. Starches give blue colour with iodine.

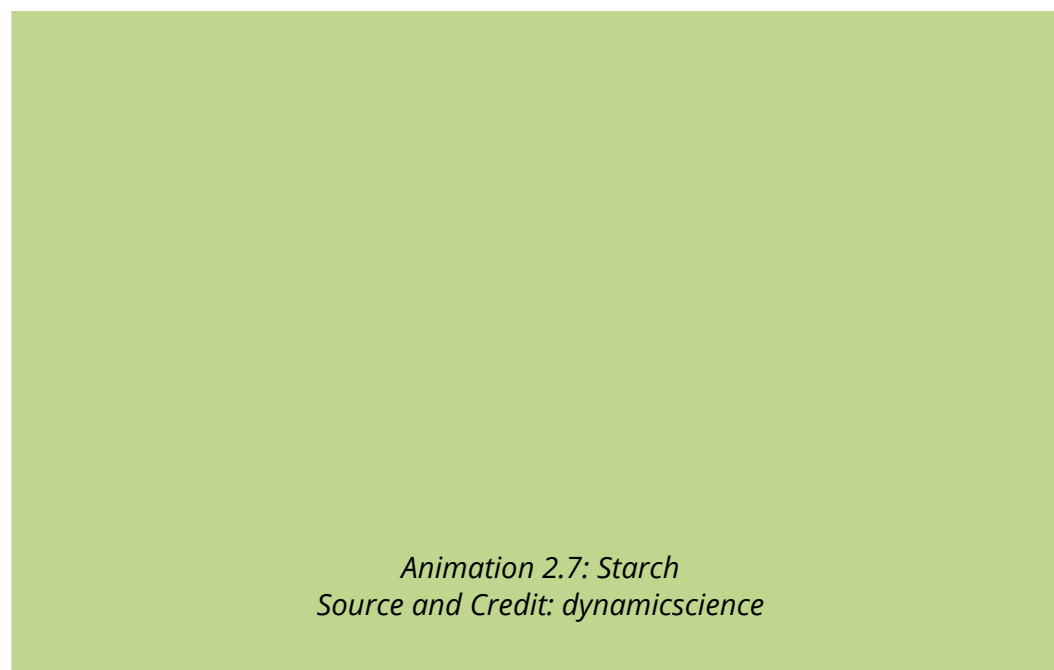

Animation 2.7: Starch
Source and Credit: dynamicscience

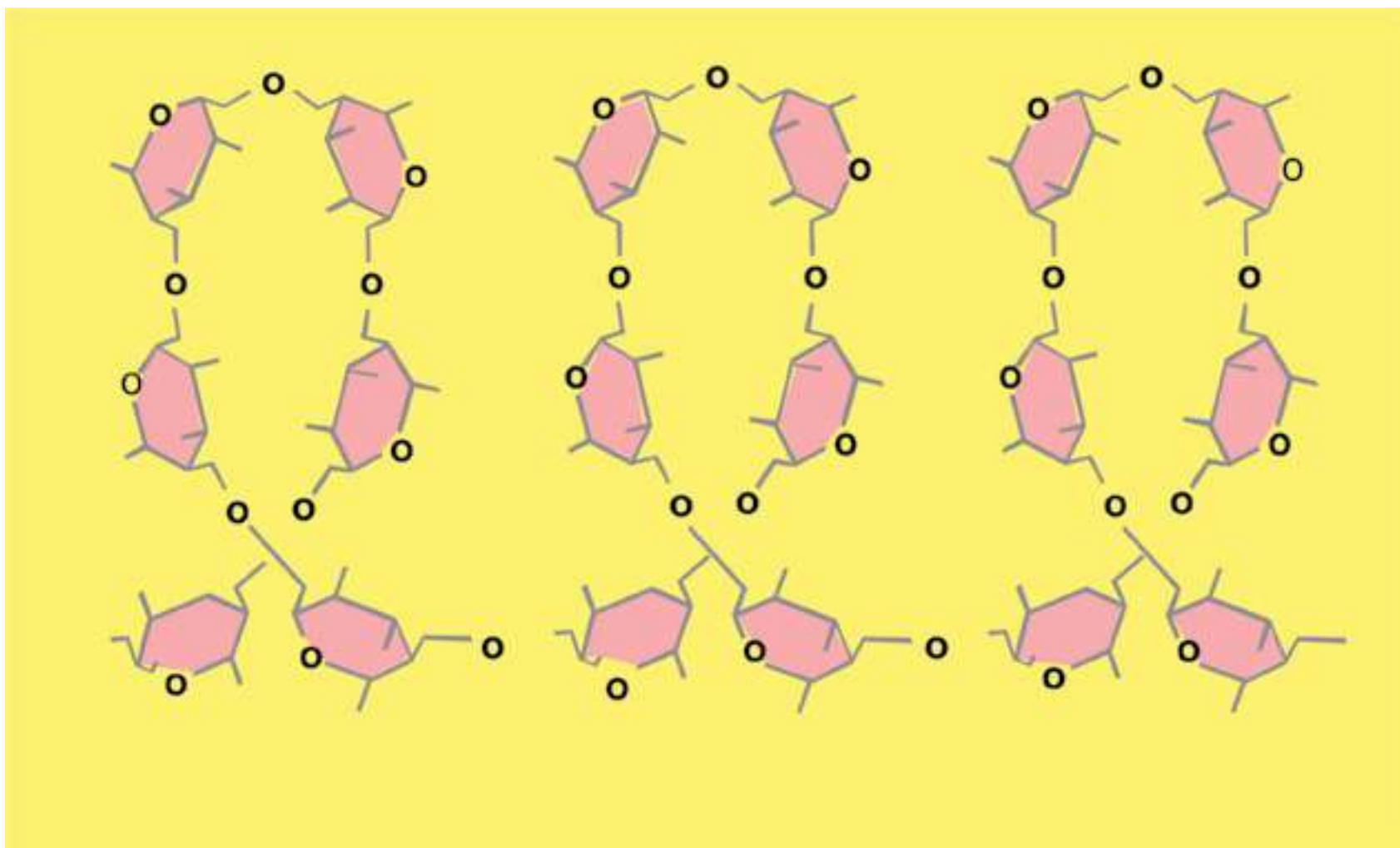

Fig 2.6.: Polysaccharides are polymers of monosaccharides.

Glycogen: It is also called animal starch. It is the chief form of carbohydrate stored in animal body. It is found abundantly in liver and muscles, though found in all animal cells. It is insoluble in water, and gives red colour with iodine. It also yields glucose on hydrolysis.

Cellulose: It is the most abundant carbohydrate in nature. Cotton is the pure form of cellulose. It is the main constituent of cell walls of plants and is highly insoluble in water. On hydrolysis it also yields glucose molecules. It is not digested in the human digestive tract. In the herbivores, it is digested because of micro-organisms (bacteria, yeasts, protozoa) in their digestive tract. These micro-organisms secrete an enzyme called cellulase for its digestion. Cellulose gives no colour with iodine.

LIPIDS

The lipids are a heterogeneous group of compounds related to fatty acids. They are insoluble in water but soluble in organic solvents such as ether, alcohol, chloroform and benzene. Lipids include fats, oils, waxes, cholesterol, and related compounds.

Lipids as hydrophobic compounds, are components of cellular membranes. Lipids are also used to store energy. Because of higher proportion of C-H bonds and very low proportion of oxygen, lipids store double the amount of energy as compared to the same amount of any carbohydrate. Some lipids provide insulation against atmospheric heat and cold and also act as water proof material. Waxes, in the exoskeleton of insects, and cutin, an additional protective layer on the cuticle of epidermis of some plant organs e.g. leaves, fruits, seeds etc., are some of the main examples.

Lipids have been classified as acylglycerols, waxes, phospholipids, sphingolipids, glycolipids and terpenoid lipids including carotenoids and steroids. The structure of some of these lipids is given below.

Acylglycerols

Acylglycerols are composed of glycerol and fatty acids (Fig. 2.7). The most widely spread acyl glycerol is triacyl glycerol, also called triglycerides or neutral lipids. Chemically, acylglycerols can be defined as esters of fatty acids and alcohol. An ester is the compound produced as the result of a chemical reaction of an alcohol with an acid and a water molecule is released as shown below:



As indicated by dotted squares, OH is released from alcohol and H from an acid.

H and OH combine and form a water molecule. Fatty acids are one of the most important components of triglycerides.

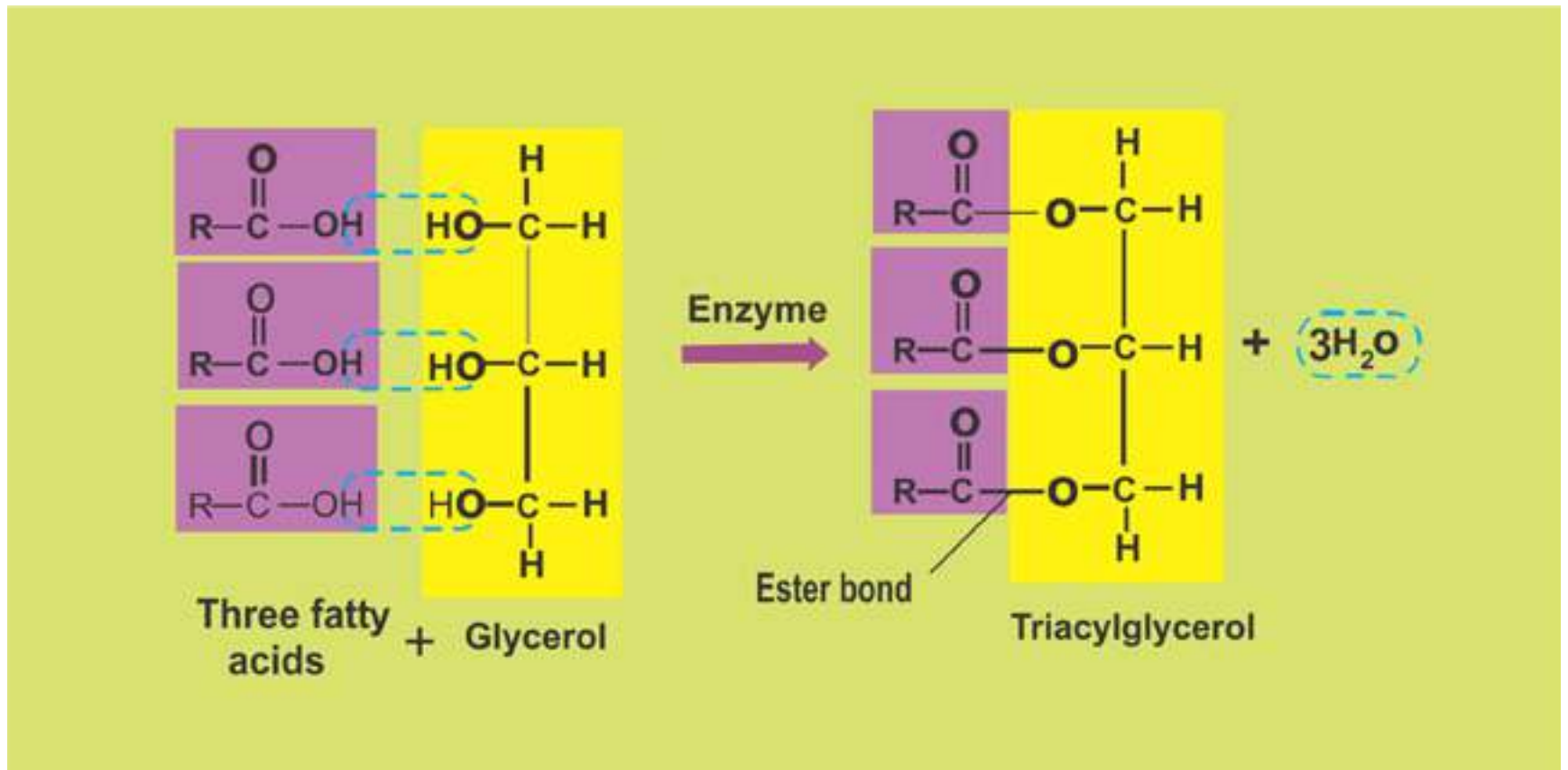

Fig. 2.7: Triacylglycerol is composed of one glycerol and three fatty acid molecules.

Animation 2.8: Triglyceride
Source and Credit: i-biology

Fatty acids contain even numbers (2-30) of carbon atoms in straight chain attached with hydrogen and having an acidic group COOH (carboxylic group). They may contain no double bond (saturated fatty acids) or up to 6 double bonds (unsaturated fatty acids). In animals the fatty acids are straight chains (Fig. 2.8.), while in plants these may be branched or ringed. Solubility of fatty acids in organic solvents and their melting points increase with increasing number of carbon atoms in chain. Palmitic acid (C₁₆) is much more soluble in organic solvent than butyric acid (C₄). The melting point of palmitic acid is 63.1°C as against -8°C for butyric acid.

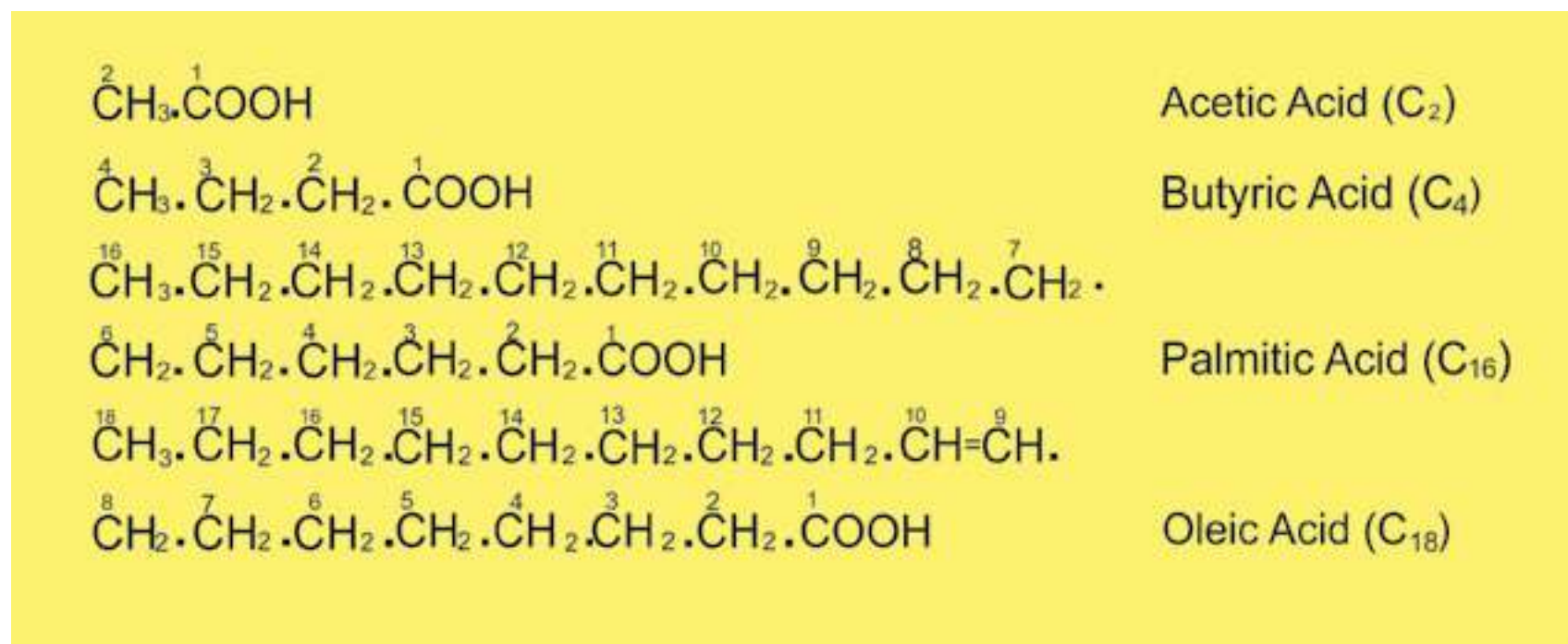

Fig. 2.8: Some fatty acids with carbon numbers 2-18 are shown. Oleic acid is an unsaturated fatty acid (note a double bond between C₉ and C₁₀). Other fatty acids are saturated.

Fats containing unsaturated fatty acids are usually liquid at room temperature and are said to be oils. Fats containing saturated fatty acids are solids. Animal fats are solid at room temperature, whereas most of the plant fats are liquids. Fats and oils are lighter than water and have a specific gravity of about 0.8. They are not crystalline but some can be crystallized under specific conditions.

Waxes

Waxes are widespread as protective coatings on fruits and leaves. Some insects also secrete wax. Chemically, waxes are mixtures of long chain alkanes (with odd number of carbons atoms ranging from C₂₅ to C₃₅) and alcohols, ketones and esters of long chain fatty acids. Waxes protect plants from water loss and abrasive damage. They also provide water barrier for insects, birds and animals such as sheep.

Phospholipids

Phospholipids are derivatives of phosphatidic acid (Fig.2.9.), which are composed of glycerol, fatty acids and phosphoric acid. Nitrogenous bases such as choline, ethanolamine and serine are important components of phospholipids. They are widespread in bacteria, animal and plant cells and are frequently associated with membranes. Phosphatidylcholine is one of the common phospholipids.

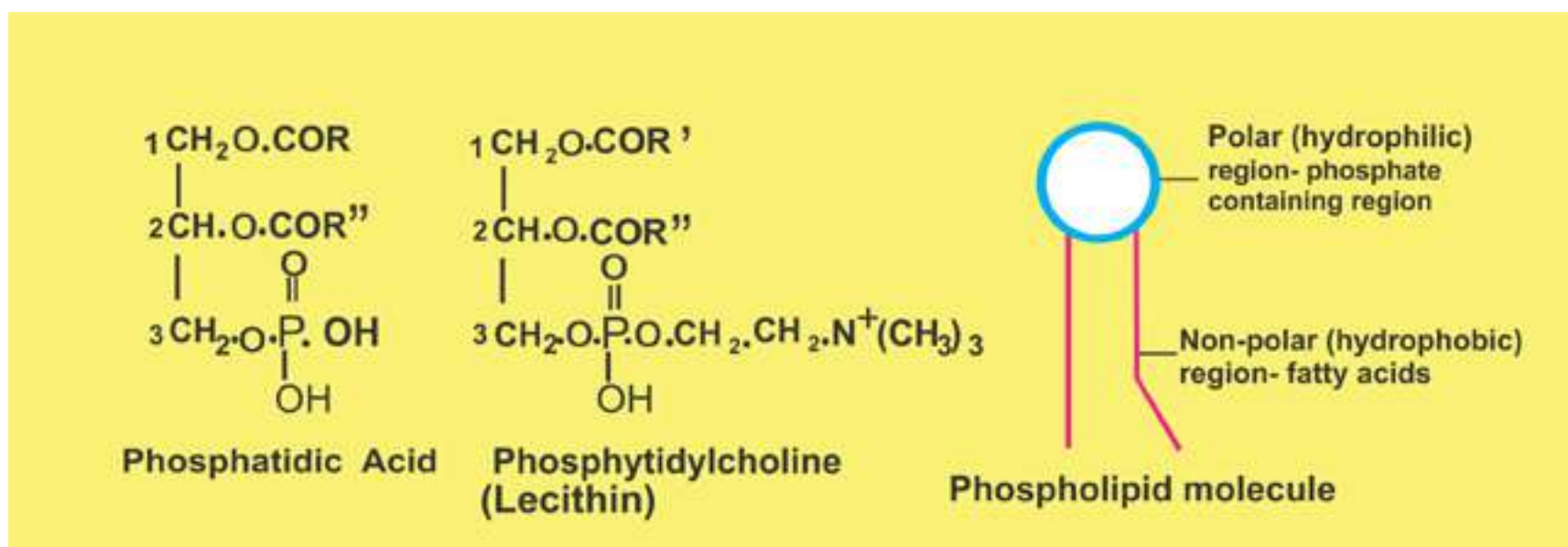

Fig. 2.9.: Phosphatidic acid is composed of glycerol, 2 fatty acids (on C1 and C2), and a phosphoric acid on C3 of glycerol. In phospholipid a nitrogenous base (e.g. choline) is attached to phosphoric acid in phosphatidic acid.

Terpenoids

Terpenoids are a very large and important group of compounds which are made up of simple repeating units, isoprenoid units. This unit by condensation in different ways gives rise to compounds such as rubber, carotenoids, steroids, terpenes etc. Lipids constitute major source of energy, and play an important role in the structure of membranes of the cell and of organelles found in the cell. They also provide insulation, mechanical protection and protection from water loss and abrasive damage.

PROTEINS

Proteins are the most abundant organic compounds to be found in cells and comprise over 50% of their total dry weight. They are present in all types of cells and in all parts of the cell.

Proteins perform many functions. They build many structures of the cell. All enzymes are proteins and in this way they control the whole metabolism of the cell. As hormones, proteins regulate metabolic processes. Some proteins (e.g. hemoglobin) work as carriers and transport specific substances such as oxygen, lipids, metal ions, etc. Some proteins called antibodies, defend the body against pathogens. Blood clotting proteins prevent the loss of blood from the body after an injury. Movement of organs and organisms, and movement of chromosomes during anaphase of cell division, are caused by proteins.

Proteins are polymers of amino acids, the compounds containing carbon, nitrogen, oxygen and hydrogen. The number of amino acids varies from a few to 3000 or even more in different proteins.

Amino acids: About 170 types of amino acids have been found to occur in cells and tissues. Of these, about 25 are constituents of proteins. Most of the proteins are however, made of 20 types of amino acids.

All the amino acids have an amino group ($-NH_2$) and a carboxyl group ($-COOH$) attached to the same carbon atom, also known as alpha carbon. They have the general formula as:

*Animation 2.9: Amino Acid
Source and Credit: wikipedia*

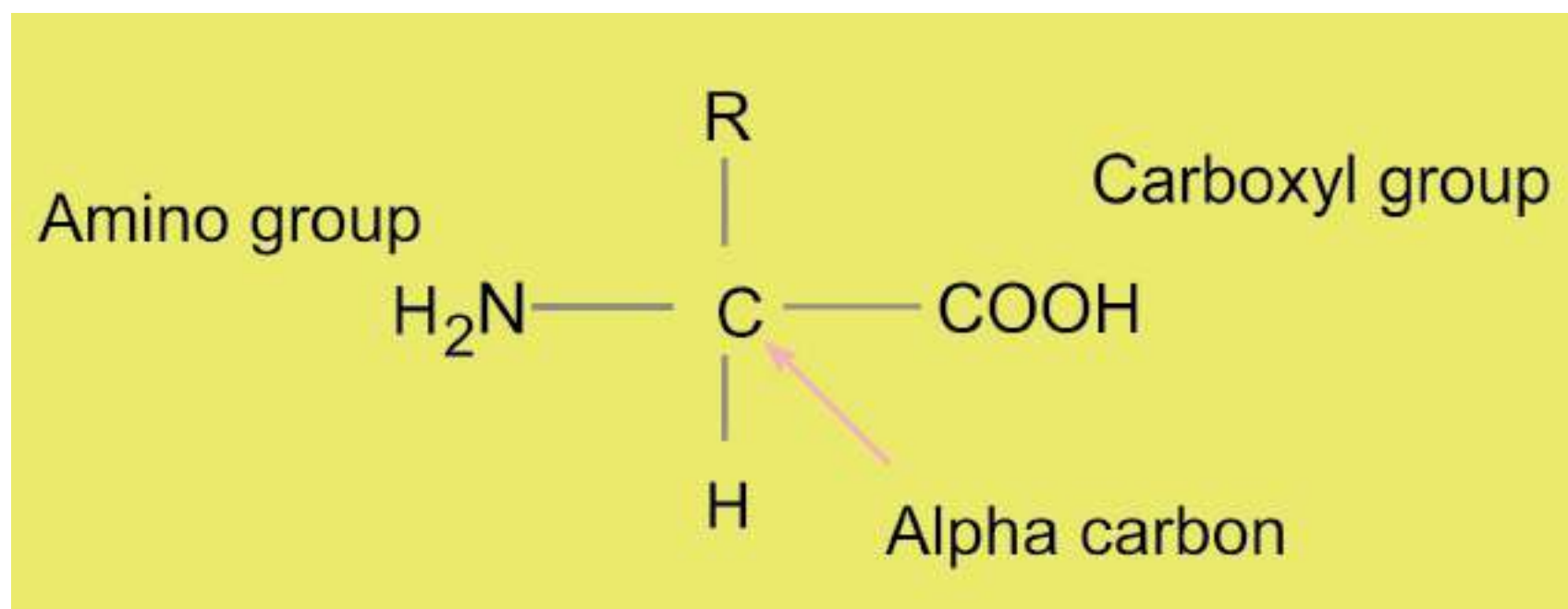

R may be a hydrogen atom as in glycine, or CH_3 as in alanine, or any other group. So amino acids mainly differ due to the type or nature of R group.

Amino acids are linked together to form polypeptides **proteins**. The amino group of one amino acid may react with the carboxyl group of another releasing a molecule of water. For example, glycine and alanine may combine as shown in Fig.2.10.

The linkage between the hydroxyl group of carboxyl group of one amino acid and the hydrogen of amino group of another amino acid release H_2O and C - N link, to form a bond called **peptide bond**. The resultant compound glycylalanine, has two amino acid subunits and is a dipeptide. A dipeptide has an amino group at one end and a carboxyl group at the other end of the molecule. So both reactive parts are again available for further peptide bonds to produce tripeptides, tetrapeptides, and pentapeptides etc, leading to polypeptide chains.

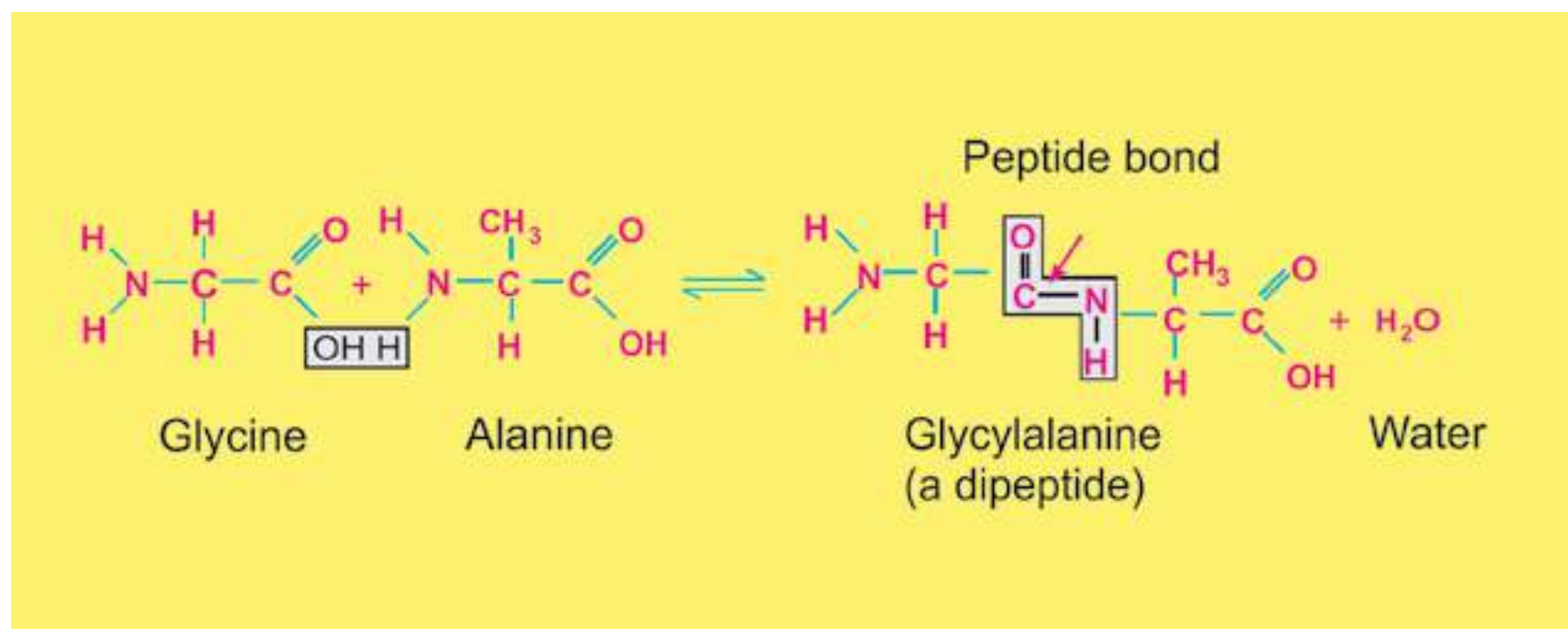

Fig. 2.10 Peptide linkage - formation of peptide bond

STRUCTURE OF PROTEINS

Each protein has specific properties which are determined by the number and the specific sequence of amino acids in a molecule, and upon the shape which the molecule assumes as the chain folds into its final, compact form. There are four levels of organization which are described below.

Primary structure: The primary structure comprises the number and sequence of amino acids in a protein molecule. F. Sanger was the first scientist who determined the sequence of amino acids in a protein molecule. After ten years of careful work, he concluded, that insulin is composed of 51 amino acids in two chains.

One of the chains had 21 amino acids and the other had 30 amino acids and they were held together by disulphide bridges. Haemoglobin is composed of four chains, two alpha and two beta chains. Each alpha chain contains 141 amino acids, while each beta chain contains 146 amino acids (Fig. 2.11). The size of a protein molecule is determined by the type of amino acids and the number of amino acids comprising that particular protein molecule.

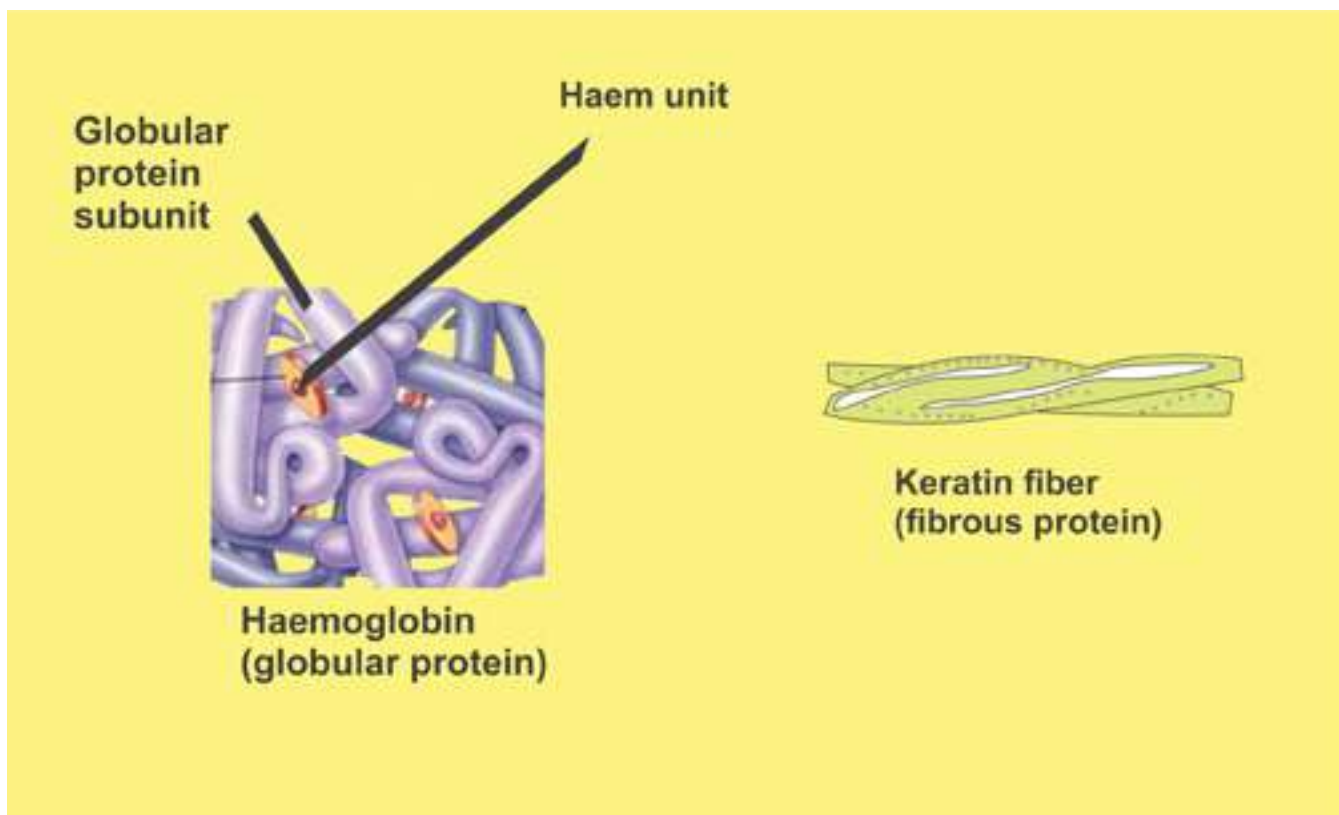

Fig. 2.11. Polypeptide chains in keratin (fibrous protein) and in haemoglobin (globular protein) are held together to form respective functional proteins.

Now we know that there are over 10,000 proteins in the human body which are composed of unique and specific arrangements of 20 types of amino acids. The sequence is determined by the order of nucleotides in the DNA. The arrangement of amino acids in a protein molecule is highly specific for its proper functioning. If any amino acid is not in its normal place, the protein fails to carry on its normal function. The best example is the sickle cell hemoglobin of human beings. In this case only one amino acid in each beta chain out of the 574 amino acids do not occupy the normal place in the proteins (in fact this particular amino acid is replaced by some other amino acid), and the hemoglobin fails to carry any or sufficient oxygen, hence leading to death of the patient.

Secondary structure: The polypeptide chains in a protein molecule usually do not lie flat. They usually coil into a helix, or into some other regular configuration. One of the common secondary structures is the α -helix. It involves a spiral formation of the basic polypeptide chain. The α -helix is a very uniform geometric structure with 3.6 amino acids in each turn of the helix. The helical structure is kept by the formation of hydrogen bonds among amino acid molecules in successive turns of the spiral. β -pleated sheet is formed by folding back of the polypeptide.

Tertiary structure: Usually a polypeptide chain bends and folds upon itself forming a globular shape. This is the proteins' tertiary conformation. It is maintained by three types of bonds, namely ionic, hydrogen, and disulfide (-S-S-). For example, in aqueous environment the most stable tertiary conformation is that in which hydrophobic amino acids are buried inside while the hydrophilic amino acids are on the surface of the molecule.

Quaternary structure: In many highly complex proteins, polypeptide tertiary chains are aggregated and held together by hydrophobic interactions, hydrogen and ionic bonds. This specific arrangement is the quaternary structure. Haemoglobin, the oxygen carrying protein of red blood cells, exhibits such a structure.

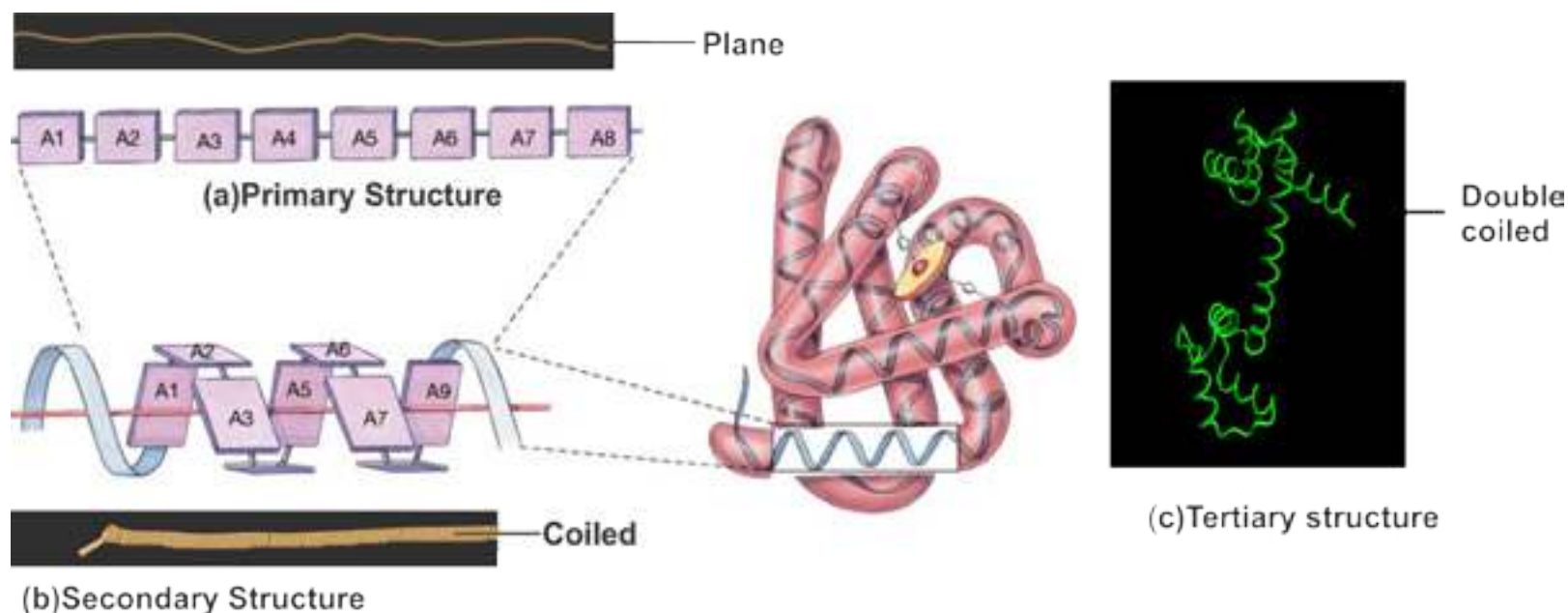

Fig 2.12 Three levels of protein structures compared with a telephone wire

Classification of proteins

Because of the complexity of structure and diversity in their function, it is very difficult to classify proteins in a single well defined fashion. However, according to their structure, proteins are classified as follows:

Fibrous proteins: They consist of molecules having one or more polypeptide chains in the form of fibrils. Secondary structure is most important in them. They are insoluble in aqueous media. They are non-crystalline and are elastic in nature. They perform structural roles in cells and organisms. Examples are silk fiber (from silk worm, and spiders' web) myosin (in muscle cells), fibrin (of blood clot), and keratin (of nails and hair).

Globular proteins: These are spherical or ellipsoidal due to multiple folding of polypeptide chains. Tertiary structure is most important in them. They are soluble in aqueous media such as salt solution, solution of acids or bases, or aqueous alcohol. They can be crystallized. They disorganize with changes in the physical and physiological environment. Examples are enzymes, antibodies, hormones and hemoglobin.

NUCLEIC ACIDS (DNA AND RNA)

Nucleic acids were first isolated in 1869 by F. Miescher from the nuclei of pus cells. Due to their isolation from nuclei and their acidic nature, they were named nucleic acids. Nucleic acids are of two types, deoxyribonucleic acid or DNA and ribonucleic acid or RNA. DNA occurs in chromosomes, in the nuclei of the cells and in much lesser amounts in mitochondria and chloroplasts. RNA is present in the nucleolus, in the ribosomes, in the cytosol and in smaller amounts in other parts of the cell.

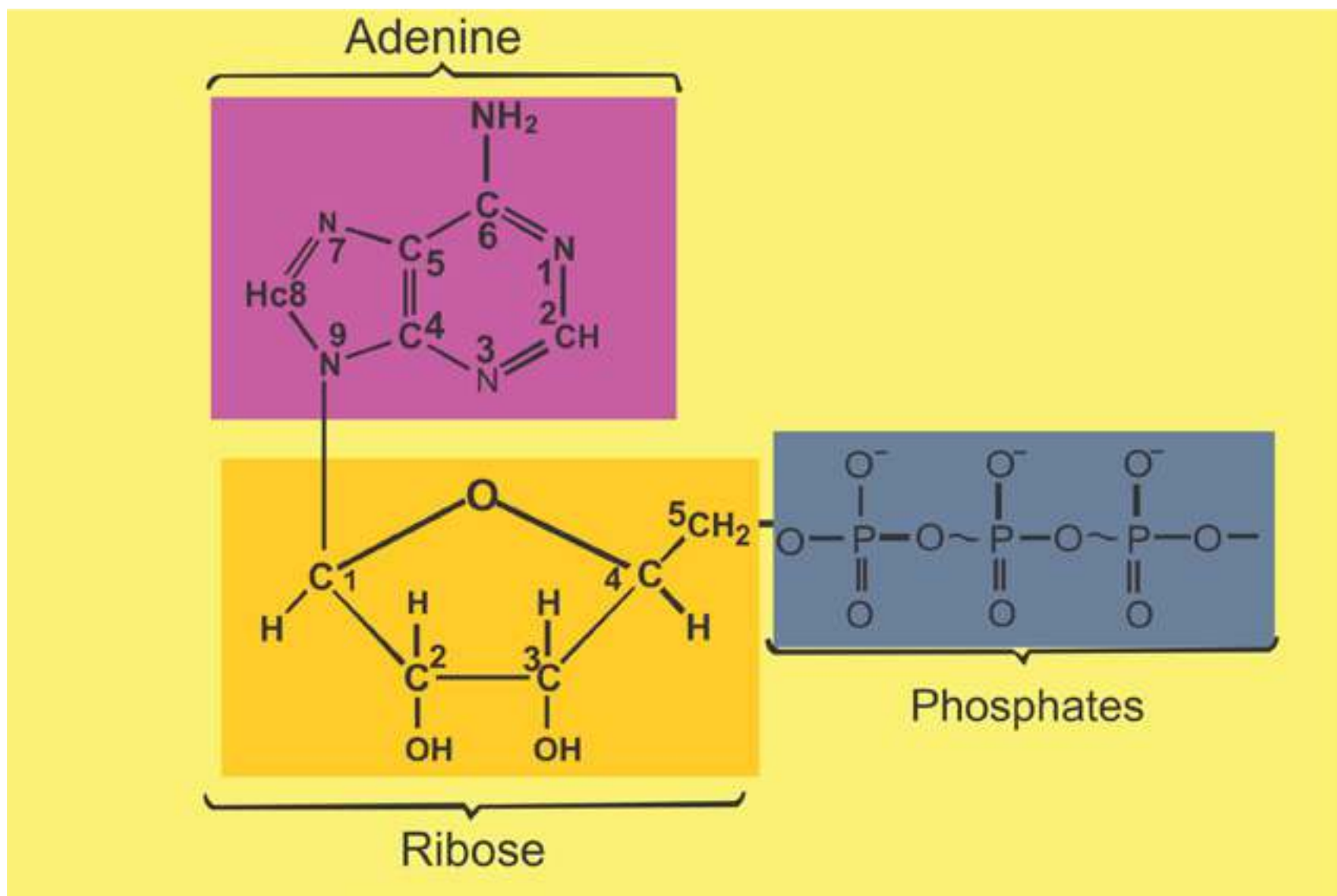

Fig. 2.13. Structural formula of ATP (a nucleotide)

Nucleic acids are complex substances. They are polymers of units called nucleotides. DNA is made up of deoxyribonucleotides, while RNA is composed of ribonucleotides. Each nucleotide is made of three subunits, a 5-carbon monosaccharide (a pentose sugar), a nitrogen containing base, and a phosphoric acid. Pentose sugar in ribonucleotide is ribose, while in deoxyribonucleotide it is deoxyribose. Nitrogenous bases are of two types, single-ringed pyrimidines, and double-ringed Purines. Pyrimidines are cytosine (abbreviated as C), thymine (abbreviated as T), and uracil (abbreviated as U). Purines are adenine (abbreviated as A) and guanine (abbreviated as G). Phosphoric acid (H_3PO_4) has the ability to develop ester linkage with OH group of Pentose sugar. In a typical nucleotide the nitrogenous base is attached to position 1 of pentose sugar, while phosphoric acid is attached to carbon at position 5 of pentose sugar (Fig 2.13).

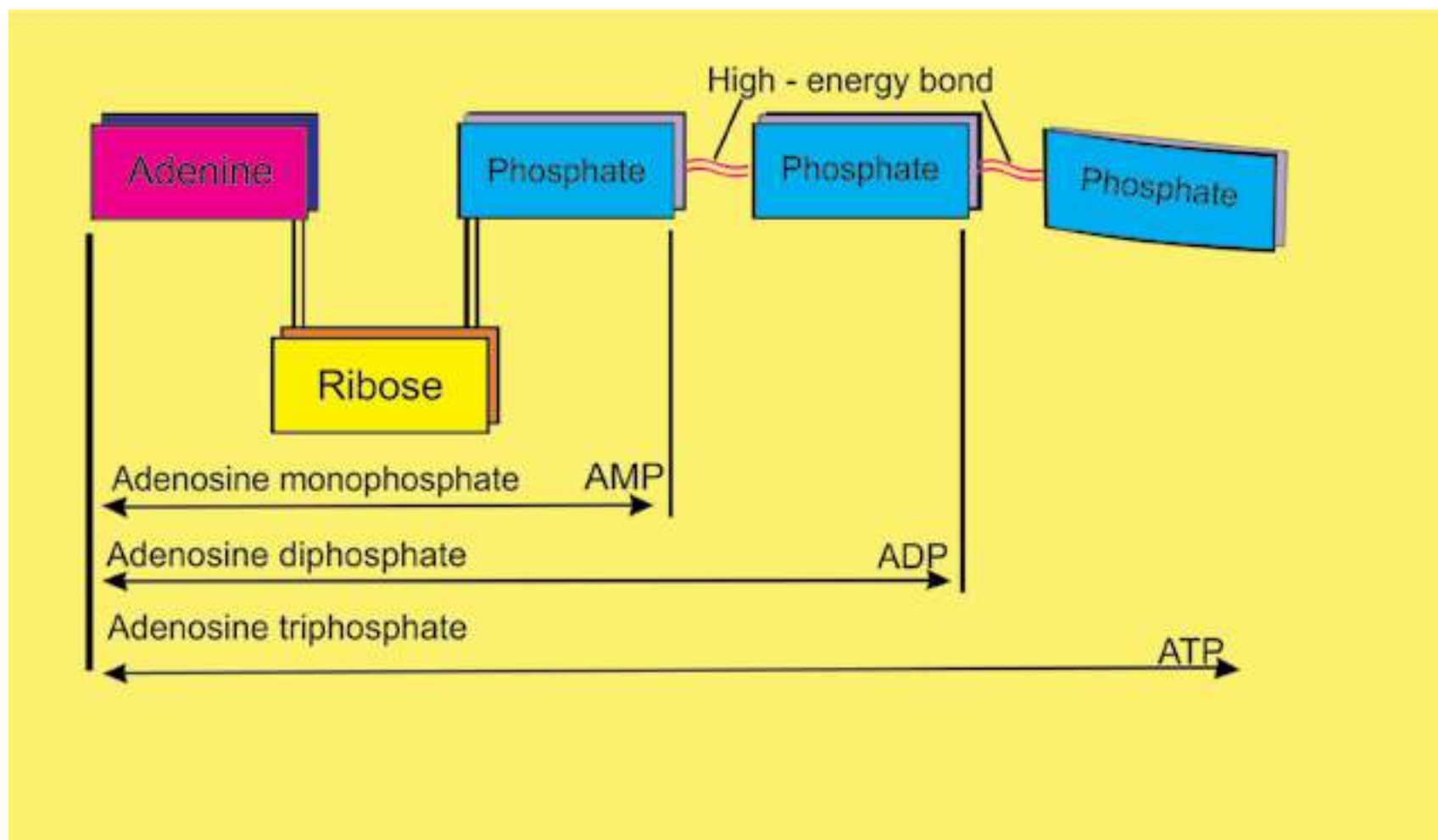
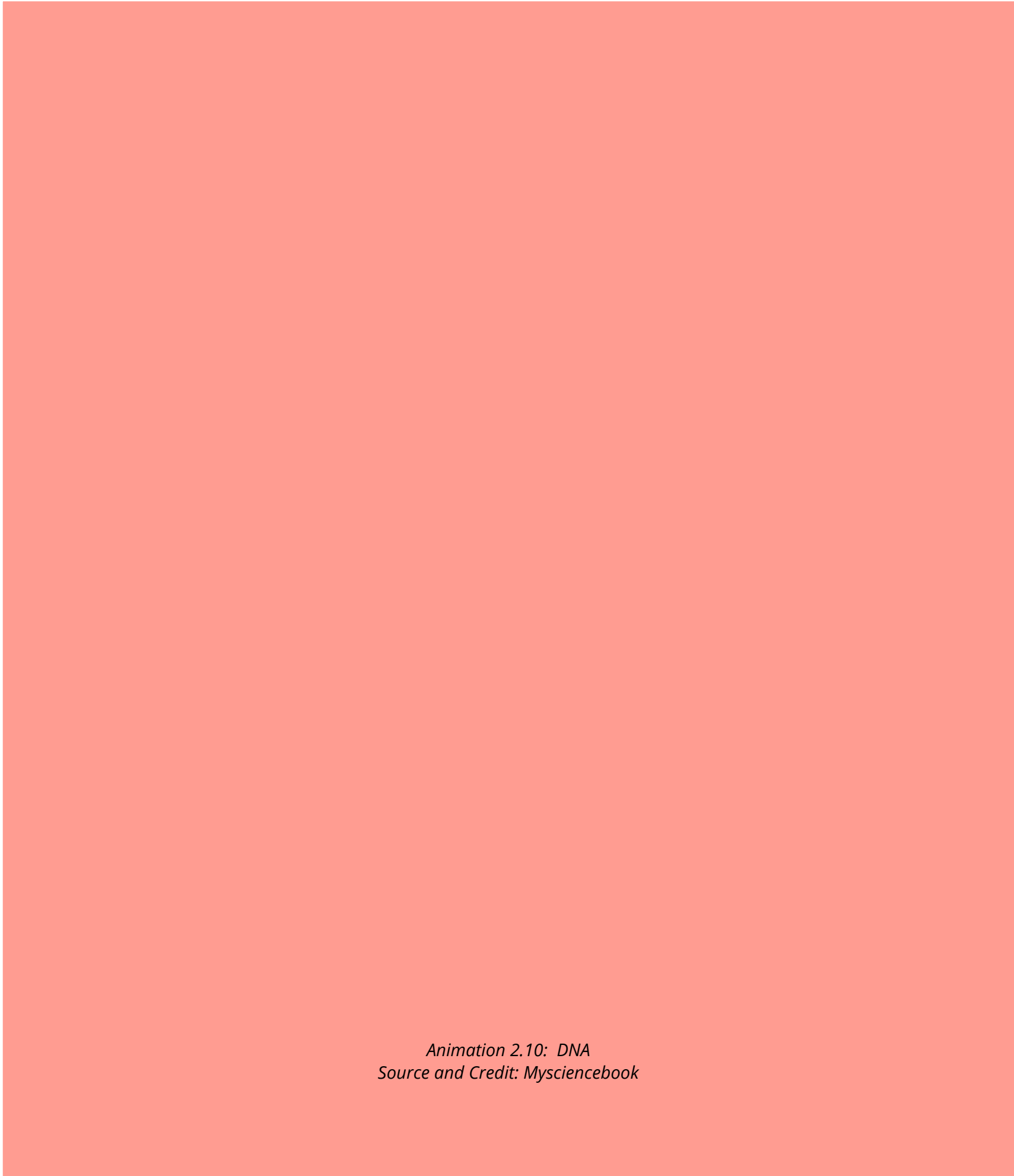

Fig. 2.14 : Components of ATP, a nucleotide.

The compound formed by combination of a base and a pentose sugar is called nucleoside. A nucleoside and a phosphoric acid combine to form a nucleotide. Each nucleotide of RNA contains ribose sugar, whereas sugar in each nucleotide of DNA is deoxyribose (one oxygen removed from OH group at carbon number 2). ATP is also an important nucleotide used as an energy currency by the cell (Fig.2.14.)

DNA (Deoxyribonucleic acid)

DNA is the heredity material. It controls the properties and potential activities of a cell. It is made of four kinds of nucleotides namely d-adenosine monophosphate (d-AMP), d-guanosine monophosphate (d-GMP), d-cytidine monophosphate (d-CMP), and d-thymidine monophosphate (d-TMP). These nucleotides are united with one another through phosphodiester linkages in a specific sequence to form long chains known as polynucleotide chains (Fig.2.15). Two nucleotides join together to form dinucleotide whereas three join together to form trinucleotide. Nicotinamide adenine dinucleotide, abbreviated as NAD, is an example of dinucleotide. It is an important coenzyme in several oxidation-reduction reactions in the cell.



Animation 2.10: DNA
Source and Credit: Mysciencebook

List of ribonucleotides and deoxyribonucleotides

RNA		DNA		
Nitrogenous base	Nucleosides (ribose + nitrogenous base)	Nucleotides (ribose + nitrogenous base + phosphoric acid)	Nucleosides (deoxyribose + nitrogenous base)	Nucleotides (deoxyribose + nitrogenous base + phosphoric acid)
Adenine	Adenosine	AMP, ADP, ATP	d-Adenosine	dAMP, dADP, dATP
Uracil	Uridine	UMP, UDP, UTP		
Guanine	Guanosine	GMP, GDP, GTP	d-Guanosine	dGMP, dGDP, dGTP
Cytosine	Cytidine	CMP, CDP, CTP	d-Cytidine	dCMP, dCDP, dCTP
Thymine			d-Thymidine	dTMP, dTDP, dTTP

In 1951 Erwin Chargaff provided data about the ratios of different bases present in this molecule. This data suggested that adenine and thymine are equal in ratio and so are guanine and cytosine as shown below in Table 2.2.

Table 2.2: Relative amounts of bases in DNA from various organisms (on percentage basis).

Source of DNA	Adenine	Guanine	Thymine	Cytosine
Man	30.9	19.9	29.4	19.8
Sheep	29.3	21.4	28.3	21.0
Wheat	27.3	22.7	27.1	22.8
Yeast	31.3	18.7	32.9	17.1

Maurice Wilkins and Rosalind Franklin used the technique of X-ray diffraction to determine the structure of DNA. At the same time James D. Watson and Francis Crick built the scale model of DNA. All the data thus obtained strongly suggested that DNA is made of two polynucleotide chains or strands. The two strands are coiled round each other in the form of a double helix. Coiling of two strands is opposite i.e. they are coiled antiparallel to each other. The two chains are held together by weak bonds (hydrogen bonds). Adenine (A) is always opposite to thymine (T), and guanine (G) and cytosine (C) are opposite to each other. There are two hydrogen bonds between A and T pair, and three hydrogen bonds between G and C pair. The two strands are wound around each other so that there are 10 base pairs in each turn of about 34 Angstrom units (one Angstrom = one 100-millionth of a centimeter) (Fig.2.15).

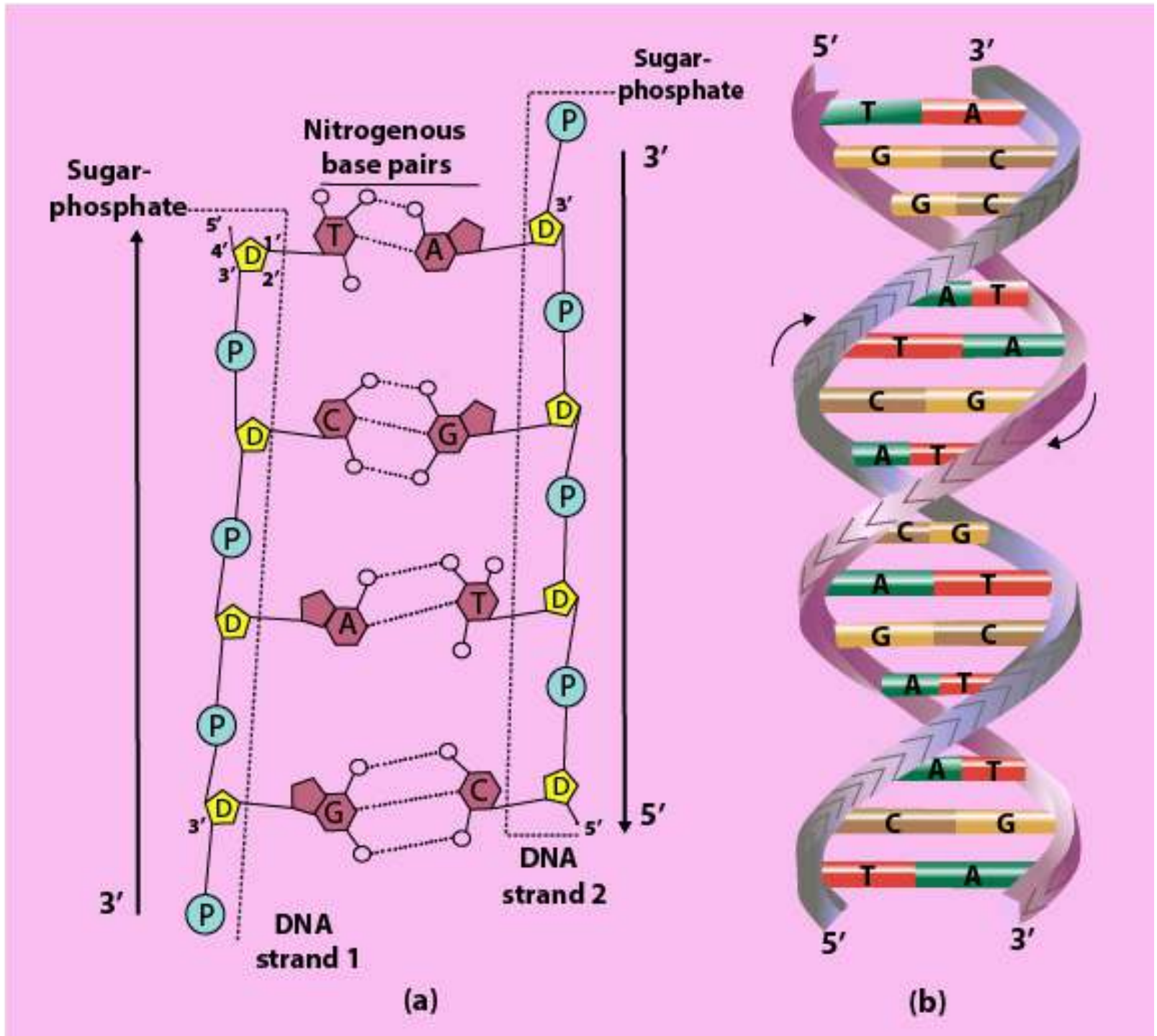

Fig. 2.15 Model of DNA. Double helical structure of DNA proposed by Watson & Crick (b). A hypothetical sequence of nucleotides (on the left side) shows hydrogen bonding between the complementary bases. Note a double bond between A and T, and triple bond between C and G (a).

The amount of DNA is fixed for a particular species, as it depends upon the number of chromosomes. The amount of DNA in germ cells (sperms and ova) is one half to that of somatic cells (Table 2.3).

Table 2.3 Amount of DNA/nucleus in different types of cells of a chicken (bird) and a carp (fish).

Type of cell	Amount of DNA/nucleus(in picogram)	
	Chicken	Crap
Red Blood Cells	2.3	3.3
Liver cells	2.4	3.3
Kidney cells	2.4	3.3
Sperm cells	1.3	1.6

All the information for the structure and functioning of a cell is stored in DNA. For example in the chromosome of the bacterium *E.coli*, each of the paired strand of DNA contains about 5 million bases arranged in a particular linear order, the information in those bases is divided into units of several hundred bases each. Each unit is a gene, a unit of biological inheritance. The *E.coli* genome consists of 4,639,221 base pairs, which code for at least 4288 proteins.

Haemophilus influenzae is the first microbe to have the genome completely sequenced and this was published on July 28, 1995.

RNA (Ribonucleic Acid)

Like DNA, RNA is a polymer of ribonucleotides. The RNA molecules occur as single strand, which may be folded back on itself, to give double helical characteristics. The nitrogenous bases form the usual complementary pairing viz. cytosine (C) with guanine (G) and uracil (U) with adenine (A). RNA is synthesized by DNA in a process known as **transcription**.

Types of RNA

Three main types of RNAs — messenger RNA (abbreviated as mRNA), transfer RNA (abbreviated as tRNA), and ribosomal RNA (abbreviated as rRNA) are recognized. All these three types of RNAs are synthesized from DNA in the nucleus and then are moved out in the cytoplasm to perform their specific functions.

Messenger RNA (mRNA): As the name indicates it takes the genetic message from the nucleus to the ribosomes in the cytoplasm to form particular proteins. Messenger RNA carries the genetic information from DNA to ribosomes, where amino acids are arranged according to the information in mRNA to form specific protein molecule. This type of RNA consists of a single strand of variable length. Its length depends upon the size of the gene as well as the protein for which it is taking the message. For example, for a protein molecule of 1,000 amino acids, mRNA will have the length of 3,000 nucleotides. mRNA is about 3 to 4% of the total RNA in the cell.

Transfer RNA (tRNA): It comprises about 10 to 20% of the cellular RNA. Transfer RNA molecules are small, each with a chain length of 75 to 90 nucleotides. It transfers amino acid molecules to the site where peptide chains are being synthesized. There is one specific tRNA for each amino acid. So the cell will have at least 20 kinds of tRNA molecules. Transfer RNA picks up amino acids and transfers them to ribosomes, where they are linked to each other to form proteins.

Ribosomal RNA (rRNA): It is the major portion of RNA in the cell, and may be up to 80% of the total RNA. It is strongly associated with the ribosomal protein where 40 to 50% of it is present. It acts as a machinery for the synthesis of proteins. On the surface of the ribosome the mRNA and tRNA molecules interact to translate the information from genes into a specific protein.



Animation 2.12: RNA
Source and Credit: Shapiro Group

CONJUGATED MOLECULES

Two different molecules, belonging to different categories, usually combine together to form conjugated molecules. Carbohydrates may combine with proteins to form glycoprotein or with lipids to form glycolipids. Most of the cellular secretions are glycoprotein in nature. Both glycoproteins and glycolipids are integral structural components of plasma membranes. Lipoprotein formed by combination of lipids and proteins are basic structural framework of all types of membranes in the cells.

Nucleic acids have special affinity for basic proteins. They are combined together to form nucleoproteins. The nucleohistones are present in chromosomes. These conjugated proteins are not only of structural, but also are of functional significance. They play an important role in regulation of gene expression.

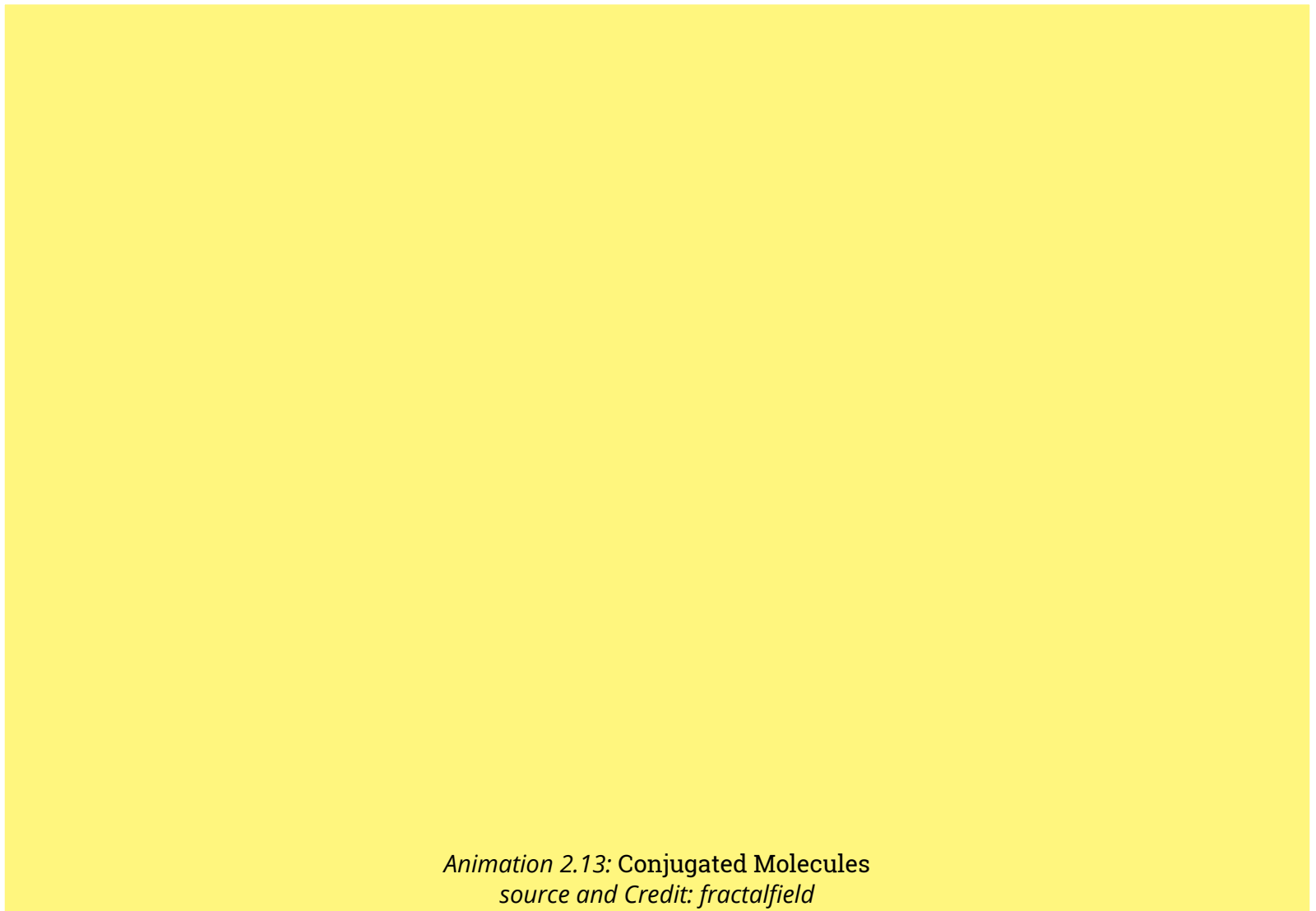

Exercise**1. Fill in the blanks.**

- i. The sum of all the chemical reactions taking place within a cell is called _____.
- ii. _____ is the basic element of organic compounds.
- iii. All the amino acids have an amino group and a carboxyl group attached to the same _____ atom.
- iv. _____ is the most abundant carbohydrate in nature.
- v. Adenine and guanine are double ringed bases and are called _____.

2. Write whether the statement is 'true' or 'false' and write the correct statement if it is false.

- i. A small proportion of water molecules are in ionized form
- ii. The covalent bond among two monosaccharides is called a peptide bond.
- iii. Glycogen is also called plant starch.
- iv. Adenine is always opposite to guanine, cytosine and thymine are opposite to each other in DNA molecule.
- v. DNA molecule is made of two polynucleotide strands

3. Short questions.

- i. Name the carbohydrates suitable as food for man.
- ii. Why are fats considered as high energy compounds?
- iii. What is the function of mRNA?
- iv. What is the general formula for amino acids?
- v. What is the percentage of water in brain cells of man?

4. Extensive questions.

- i. Describe the importance of water for life.
- ii. Describe what do you know about polysaccharides.
- iii. Write a short note on amino acids.

CHAPTER

3

Enzymes

Animation 3.1: Enzyme
Source & Credit: pharmaexchange

Enzymes are the most important group of proteins which are biologically active. They tremendously increase the efficiency of a biochemical reaction and are specific for each type of reaction. Without these enzymes the reaction would proceed at a very slow speed making life impossible.

Enzymes are composed of hundreds of amino acids joined together and coiled upon themselves to form a globular structure. The catalytic activity is restricted to a small portion of the structure known as the active site. The reactant called substrate is attached to the active site consisting of only a few amino acids, while rest of the bulk of the amino acids maintains the globular structure of the enzyme.

Some enzymes consist solely of proteins. Others also have a non-protein part known as a **co-factor**, which is essential for the proper functioning of the enzymes. The cofactor usually acts as “bridge” between the enzyme and its substrate, often it contributes directly to the chemical reactions which bring about catalysis. Sometimes the co-factor provides a source of chemical energy, helping to drive reactions which would otherwise be difficult or impossible. Some enzymes use metal ions as co-factors like Mg^{2+} , Fe^{2+} , Cu^{2+} , Zn^{2+} etc. The detachable co-factor is known as an activator if it is an inorganic ion (Fig. 3.1).

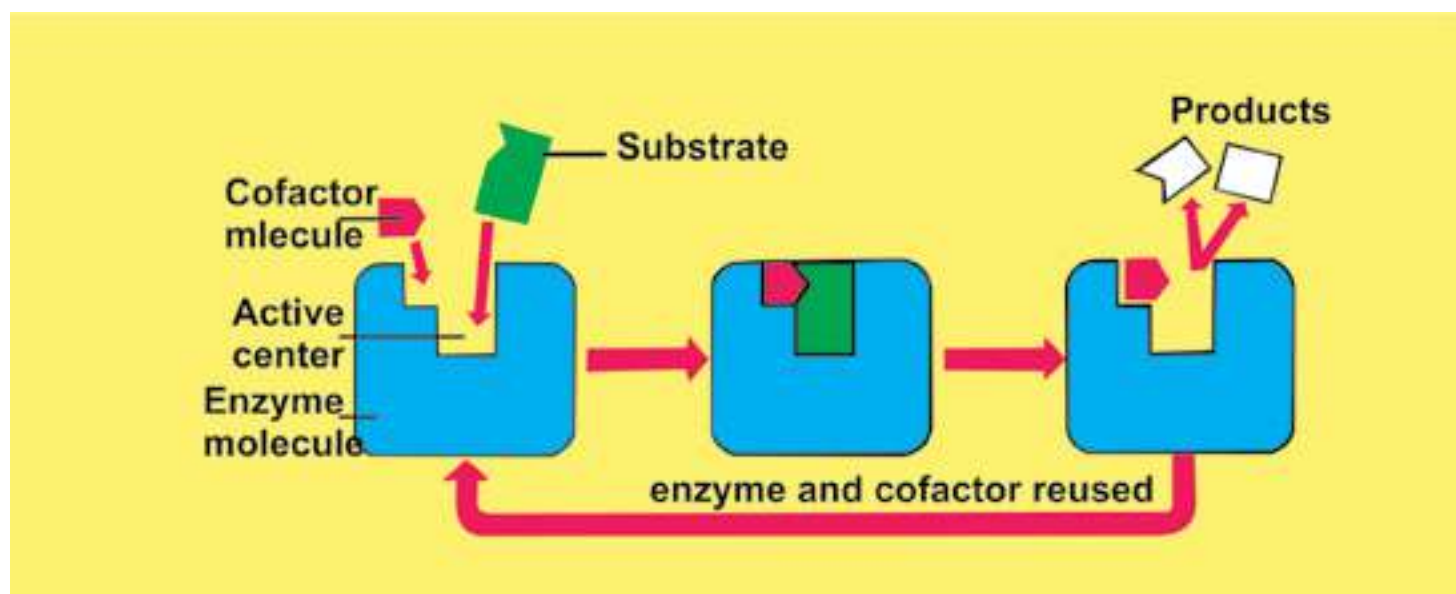
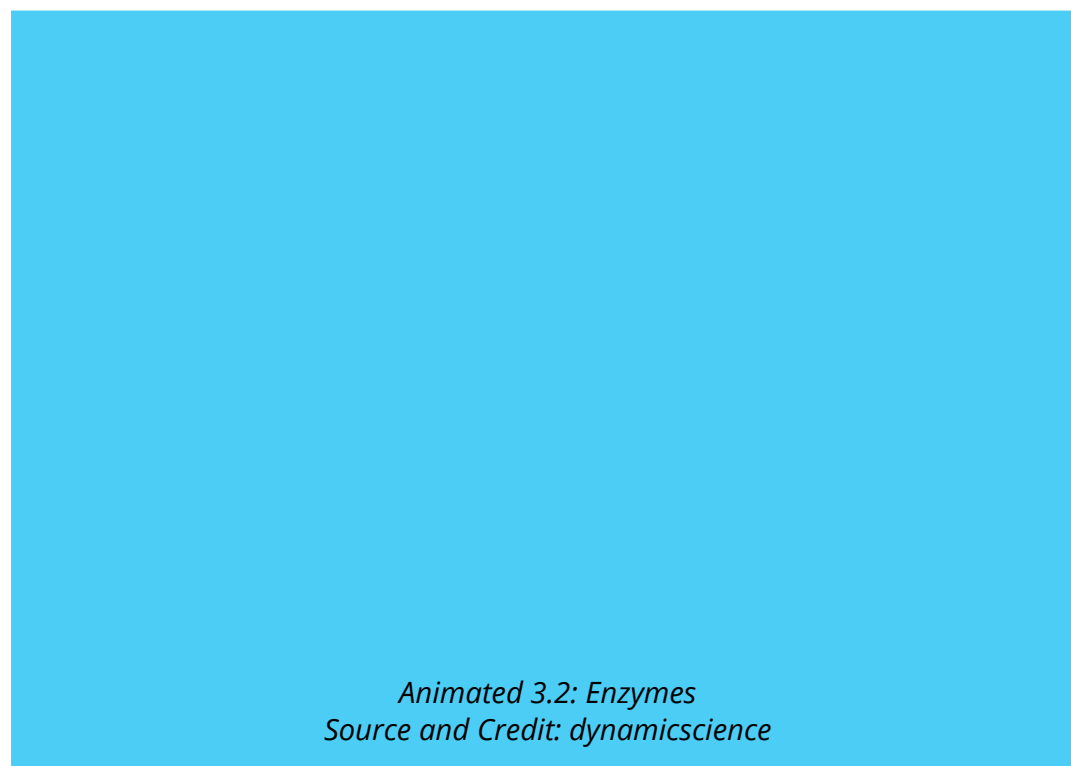

Fig. 3.1 Substrate molecules will not fit correctly at the active centre and there will be no catalytic action unless the cofactor molecule is also present

If the non-protein part is covalently bonded, it is known as a **prosthetic group**. If it is loosely attached to the protein part, it is known as **coenzyme**. It is closely related to vitamins, which represent the essential raw materials from which coenzymes are made. Only small quantities of vitamins are

needed because, like enzymes, co-enzyme can be used again and again. An enzyme with its coenzyme, or prosthetic group, removed is designated as **apoenzyme**. Adding the correct concentrated coenzyme to the apoenzyme will restore enzyme activity. An activated enzyme consisting of polypeptide chain and a cofactor is known as **holoenzyme**.

Many enzymes are simply dissolved in the cytoplasm. Other enzymes are tightly bound to certain subcellular organelles. They are produced by living cells for use in or near the site of their production. The enzymes important in photosynthesis are found in the chloroplasts and enzymes involved in cellular respiration are found in the mitochondria. Some of the enzymes which are involved in the synthesis of proteins are integral part of ribosomes.



CHARACTERISTICS OF ENZYMES

Enzymes, the biochemical catalysts possess the following important characteristics.

1. All enzymes are globular proteins.
2. They increase the rate of reaction without themselves being used up.
3. Their presence does not affect the nature or properties of end products.
4. Small amounts of an enzyme can accelerate chemical reactions.

5. They are very specific in their action; a single enzyme catalyzes only a single chemical reaction or a group of related reactions.
6. They are sensitive to even a minor change in pH, temperature and substrate concentration.
7. Some enzymes require a co-factor for their proper functioning.
8. They lower the activation energy of the reactions.

Some enzymes are potentially damaging if they are manufactured in their active form. For example, **pepsin** is a powerful protein - digesting enzyme and is quite capable of destroying cell's internal structure and thus is produced in inactive **pepsinogen** form by the cell. It is converted in its active form only in the digestive tract where it is required to be active.

MECHANISM OF ENZYME ACTION (CATALYSIS)

An enzyme is a three dimensional globular protein that has specific chemical composition due to its component amino acids and a specific shape. Every enzyme by virtue of its specificity recognizes and reacts with a special chemical substance called substrate. Any enzyme, therefore, reacts only with its specific substrate and transforms it into product(s). It is then released unaltered and thus can be used again and again.

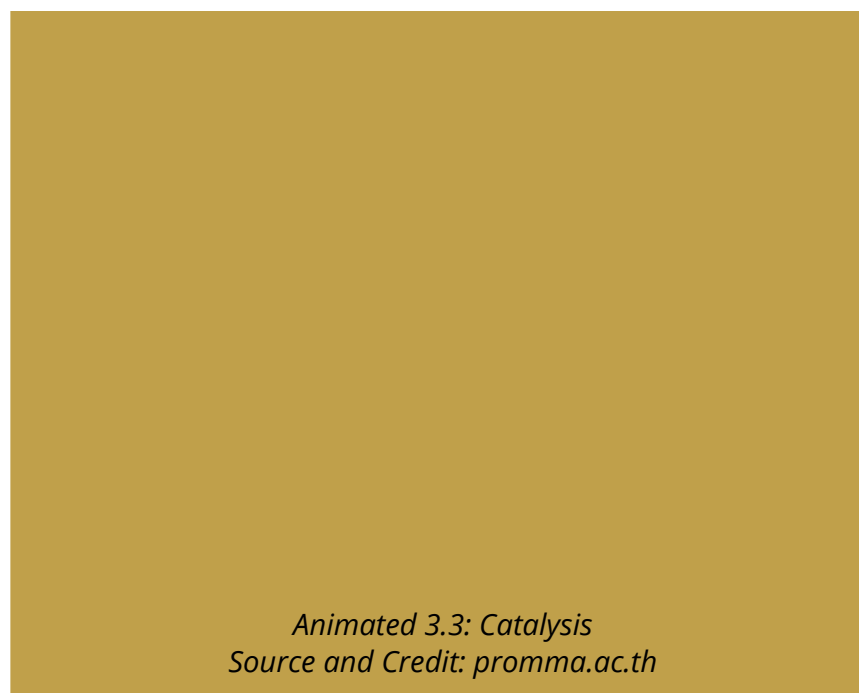
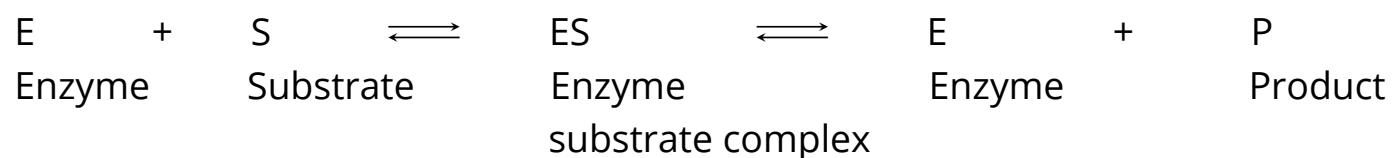

In certain cases enzymes act in a series of chemical reactions in a particular order to complete a metabolic pathway such as respiration or photosynthesis. The successive enzymes containing these reactions are normally present together in a precise order of reaction such that substrate molecules can be literally handed on from one enzyme to another forming an enzyme to enzyme chain. In this way, the products from one step in pathway are transferred to the enzyme catalyzing the next step.

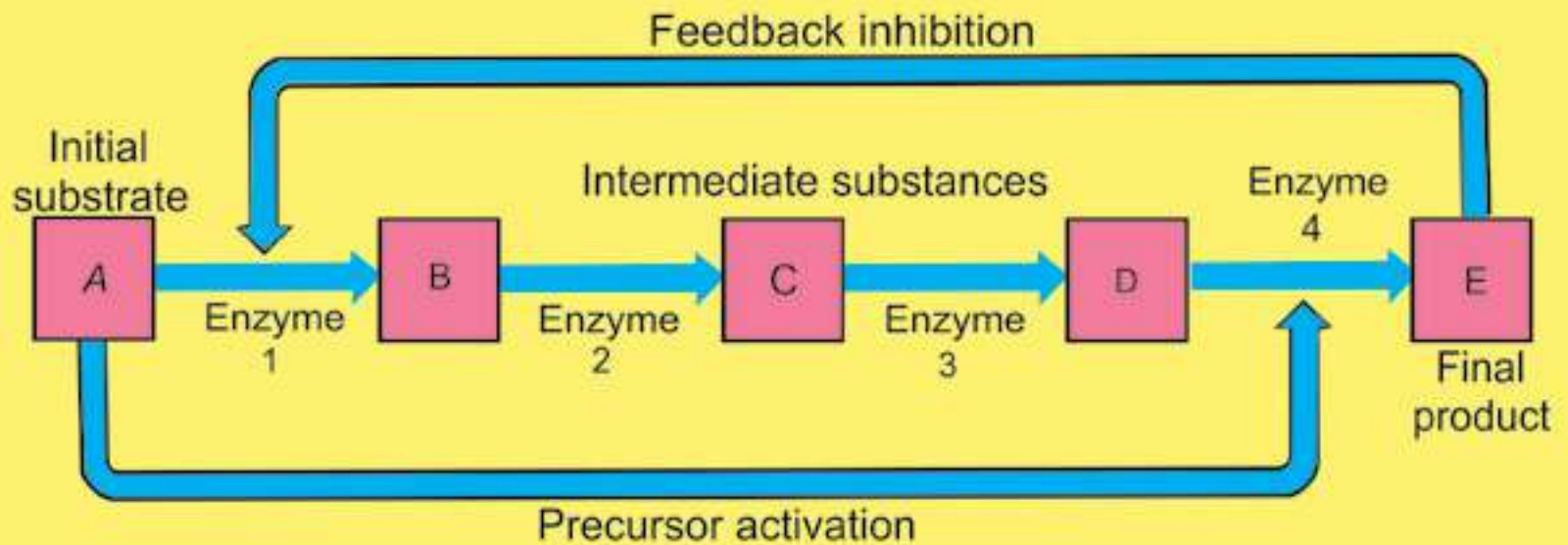

Fig. 3.2 Enzyme to enzyme chain (association)

Animated 3.4: Enzyme to enzyme chain
(association)
Source and Credit: faculty.ccbcmd

An enzyme and its substrate react with each other through a definite charge-bearing site of an enzyme called active site. The charge and shape of the active site is formed by some amino acids present in the polypeptide chain of the active site of the enzyme. These amino acids are brought closer and are arranged in a specific way by coiling and folding of the polypeptide chain within the globular symmetry of the enzyme (Fig. 3.3).

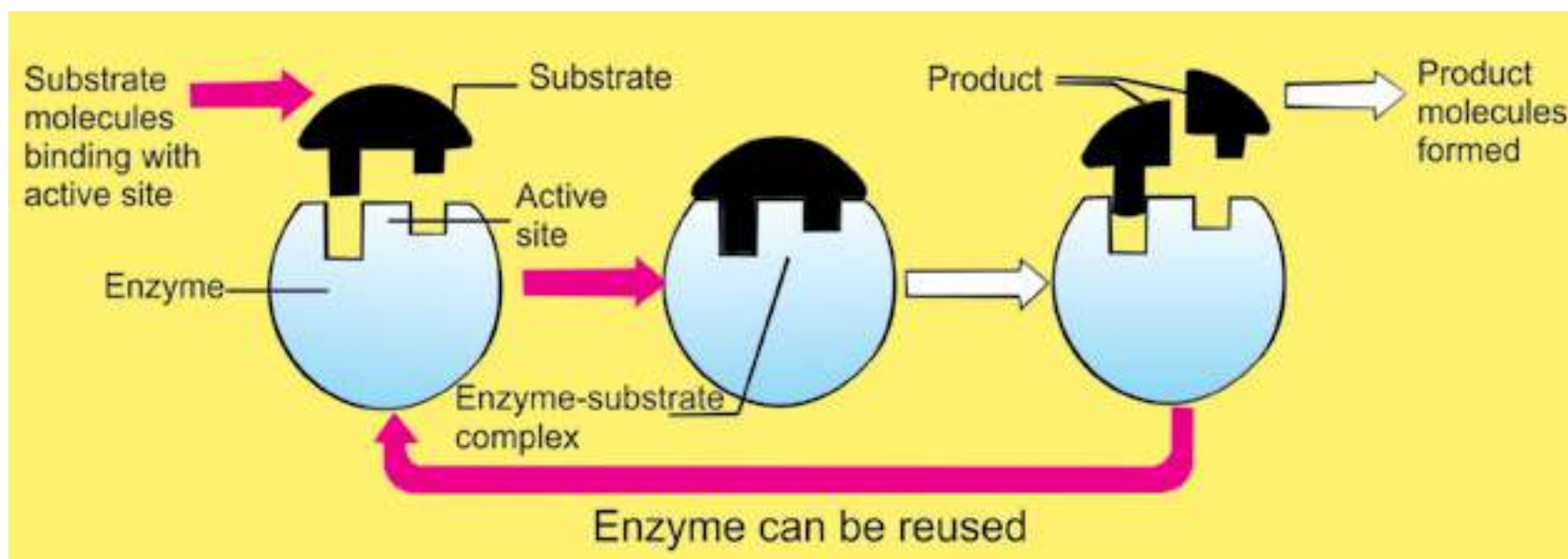

Fig. 3.3 Diagrammatic representation of an enzyme-substrate reaction (Lock and Key Model)

The active site of the enzyme is made up of two definite regions i.e the binding site and the catalytic site. The binding site helps the enzyme in the recognition and binding of a proper substrate to produce an ES complex. This reaction activates the catalytic site. Activated catalytic site catalyzes the transformation of the substrate into product(s). Thus the enzyme after catalysis detaches itself from the products unchanged. Enzyme requires aqueous medium for its activity.

Most enzymes do not float about in a kind of cytoplasmic soup' but are attached to membrane systems inside the cell in specific and orderly arrangements. Mitochondria and chloroplasts are good examples of this.

Emil Fischer (1890) proposed a Lock and Key model to visualize substrate and enzyme interaction. According to this model, as one specific key can open only a specific lock, in the same manner a specific enzyme can transform only one substrate into products(s).

According to Lock and Key Model the active site is a rigid structure. There is no modification or flexibility in the active site before, during or after the enzyme action and it is used only as a template. Later studies did not support this model in all reactions.

On the basis of new evidences Koshland (1959) proposed its modified form. This is known as Induce Fit Model.

He argued that when a substrate combines with an enzyme, it induces changes in the enzyme structure. The change in structure enables the enzyme to perform its catalytic activity more effectively.

FACTORS AFFECTING THE RATE OF ENZYME ACTION

The functional specificity of every enzyme is the consequence of its specific chemistry and configuration. Any factor that can alter the chemistry and shape of an enzyme can affect its rate of catalysis. Some of the important factors that can affect the rate of enzyme action are: concentration of enzyme, concentration of substrate, temperature, and pH of the medium.

1. Enzyme Concentration

The rate of reaction depends directly on the amount of enzyme present at a specific time at unlimited substrate concentration. If the amount of enzyme is increased by two fold the reaction rate is doubled.

By increasing the enzyme molecules an increase in the number of active sites takes place. More active sites will convert the substrate molecules into product(s), in the given period of time. After a certain limiting concentration, the rate of reaction will no longer depend upon this increase.

2. Substrate Concentration

At low concentration of substrate the reaction rate is directly proportional to the substrate available.

If the enzyme concentration is kept constant and the amount of substrate is increased, a point is reached when a further increase in the substrate does not increase the rate of the reaction any more (Fig.3.4). This is because at high substrate level all the active sites of the enzyme are occupied and further increase in the substrate does not increase the reaction rate.

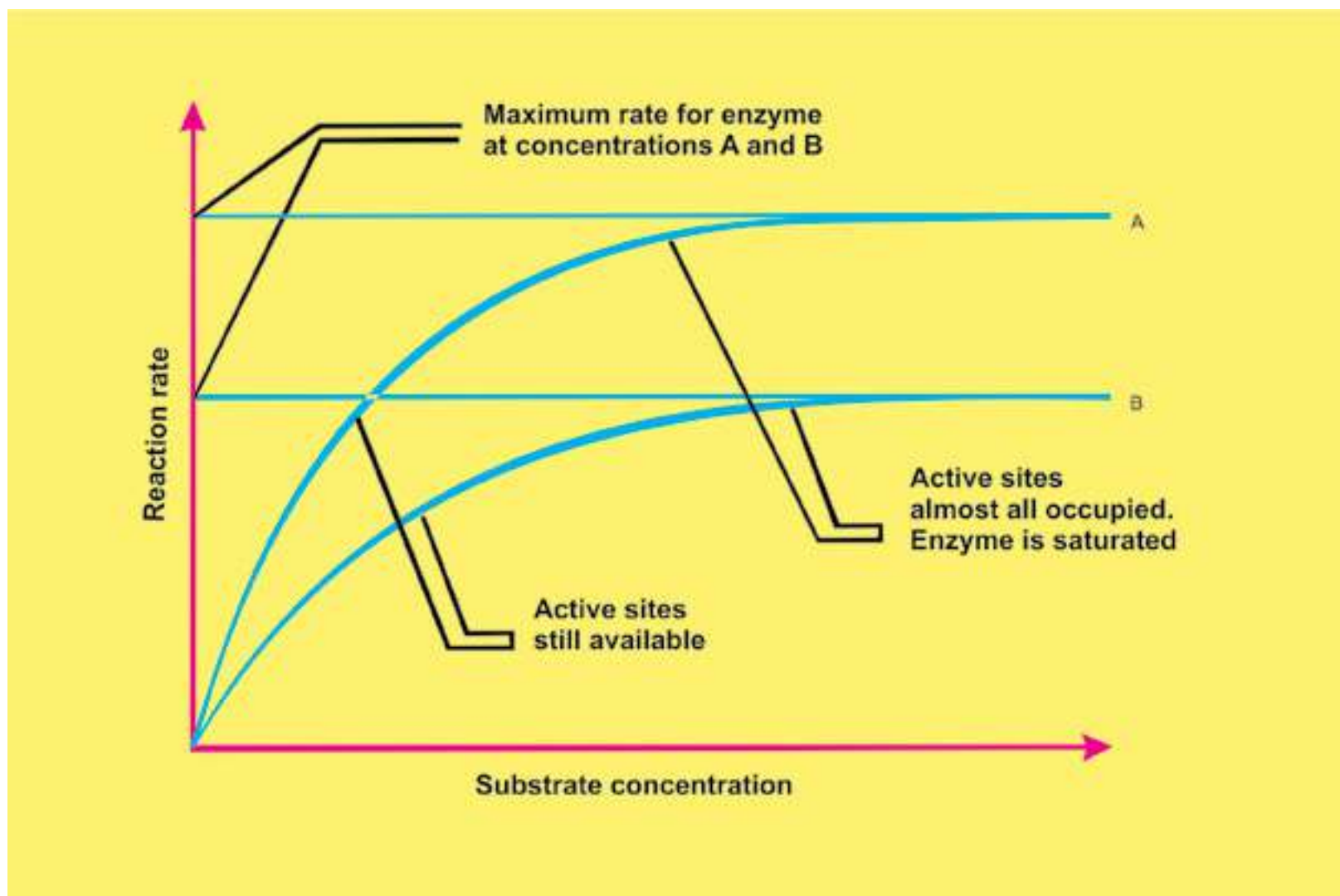

Fig. 3.4.1 Effect of substrate concentration on the rate of an enzyme catalyzed reaction.

3. Temperature

The rate of enzyme controlled reaction may increase with increase in temperature but up to a certain limit. All enzymes can work at their maximum rate at a specific temperature called as optimum temperature. For enzymes of human body 37°C is the optimum temperature (Fig.3.5).

Heat provides activation energy and therefore, chemical reactions are accelerated at high temperatures. Heat also supplies kinetic energy to the reacting molecules, causing them to move rapidly. Thus the reactants move more quickly and chances of their collision with each other are increased. However, further increase in heat energy also increases the vibrations of atoms which make up the enzyme molecule. If the vibrations become too violent, globular structure essential for enzyme activity is lost and the enzyme is said to be denatured.

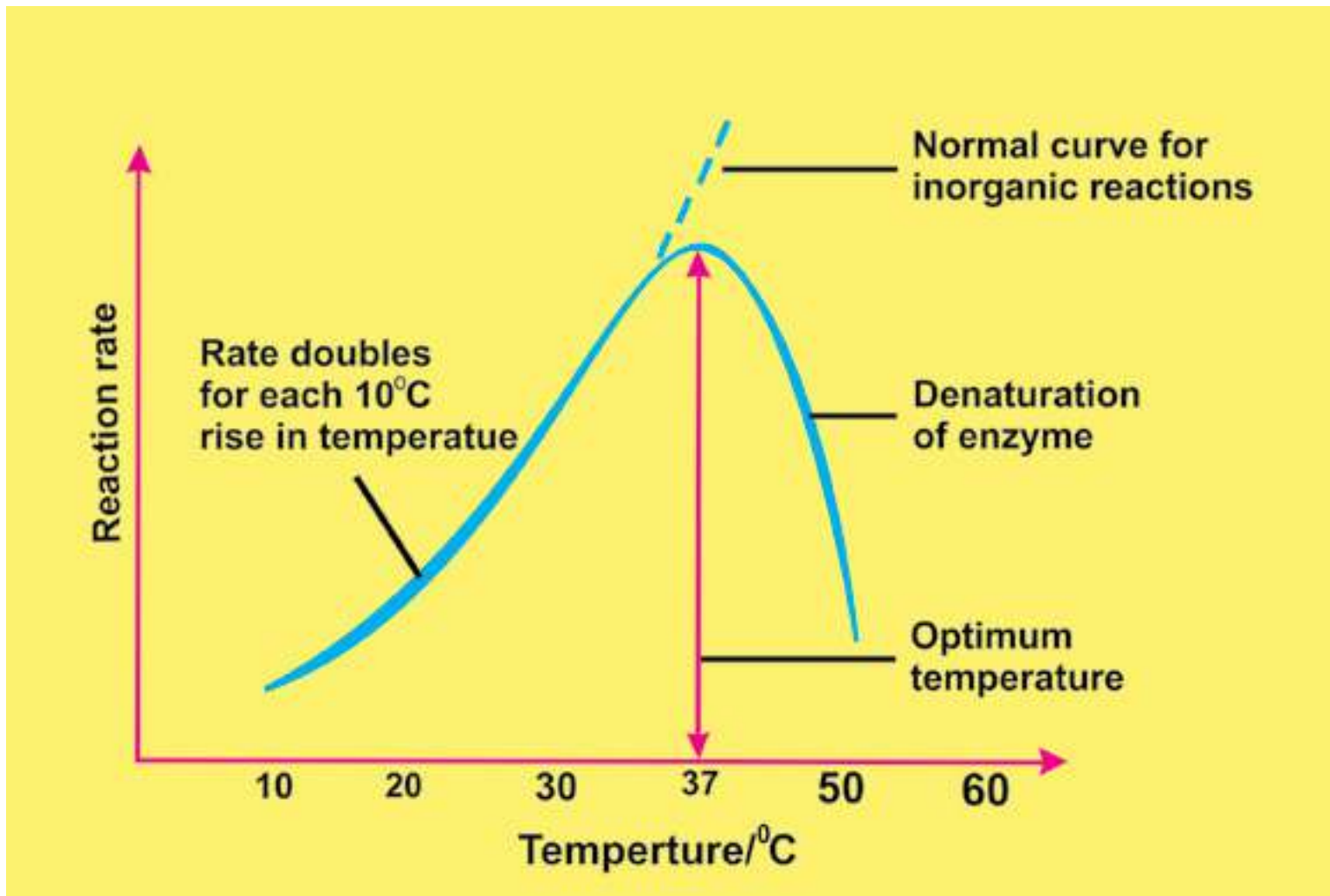

fig.3.5. Effect of temperature on the rate of an enzyme catalyzed reaction

4. pH Value

Every enzyme functions most effectively over a narrow range of pH known as the **optimum pH** as shown in Table 4.1.

A slight change in pH can change the ionization of the amino acids at the active site. Moreover, it may affect the ionization of the substrates. Under these changed conditions enzyme activity is either retarded or blocked completely.

Extreme changes in pH cause the bonds in the enzyme to break, resulting in the enzyme denaturation.

Table 4.1 Optimum pH values for some enzymes

Enzyme	Optimum pH
Pepsin	2.00
Sucrase	4.50
Enterokinase	5.50
Salivary amylase	6.80
Catalase	7.60
Chymotrypsin	7.00-8.00
Pancreatic lipase	9.00
Arginase	9.70

I. Inhibitors

An inhibitor is a chemical substance which can react (in place of substrate) with the enzyme but is not transformed into product(s) and thus blocks the active site temporarily or permanently, for example poisons, like cyanide;, antibiotics, anti-metabolites and some drugs.

Inhibitors can be divided into two types: (i) Irreversible (ii) Reversible

Irreversible Inhibitors

They check the reaction rate by occupying the active sites or destroying the globular structure. They occupy the active sites by forming covalent bonds or they may physically block the active sites.

Reversible Inhibitors

They form weak linkages with the enzyme. Their effect can be neutralized completely or partly by an increase in the concentration of the substrate.

They are further divided into two major types: A. Competitive B. Non-competitive

A. Competitive Inhibitors

Because of the structural similarity with the substrate they may be selected by the binding sites, but are not able to activate the catalytic sites. Thus product(s) are not formed (Fig.3.6).

B. Non-competitive Inhibitors

They form enzyme inhibitor complex at a point other than the active site. They alter the structure of the enzyme in such a way that even if genuine substrate binds the active site, catalysis fails to take place.

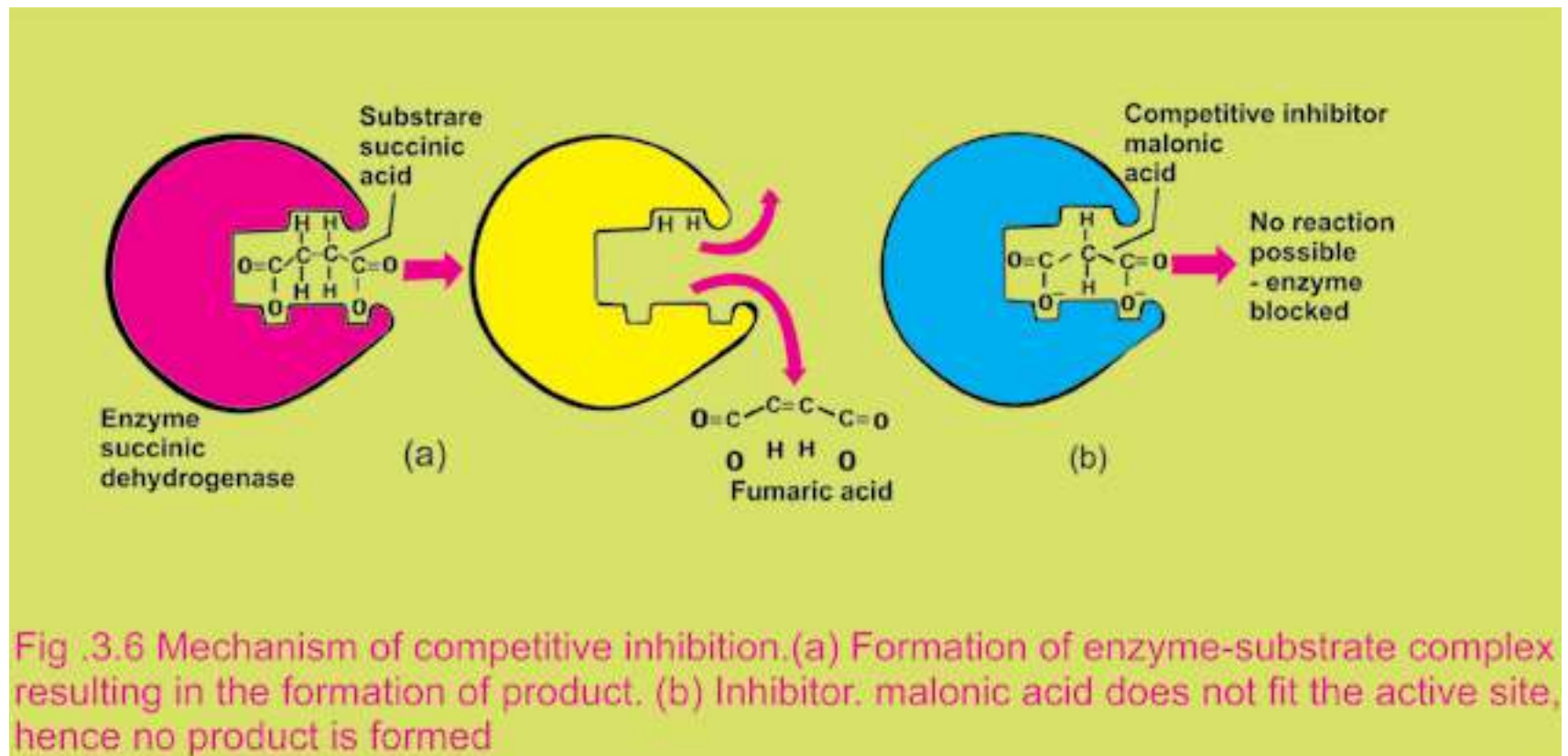

Fig .3.6 Mechanism of competitive inhibition. (a) Formation of enzyme-substrate complex resulting in the formation of product. (b) Inhibitor, malonic acid does not fit the active site, hence no product is formed

Animated 3.5: Non-competitive Inhibitors
Source and Credit: academic.brooklyn

Exercise**Q.1. Fill in the blank.**

- (i) Enzymes are composed of hundreds of _____
- (ii) Some enzymes consist of a non-protein part known as a _____
- (iii) Many enzymes require non-protein component called _____ for their proper functioning.
- (iv) Enzymes are highly _____ in nature.
- (v) The enzymes which carry out the synthesis of _____ are integral parts of ribosomes.

Q.2. Write whether the statement is 'true' or 'false' and write the correct statement if it is false.

- (i) The enzymes important in photosynthesis are found in tire mitochondria
- (ii) Large amounts-of an enzyme can accelerate chemical reactions.
- (iii) Calvin Malvin proposed Lock and Key model for enzyme action.
- (iv) The active site of an enzyme is composed of four regions.
- (v) Structure of an enzyme has no specific importance.

Q.3. Short Questions

- (i) List two conditions that destroy enzymatic activity by disrupting bonds between the atoms in an enzyme.
- (ii) How do low and high temperature, affect an enzyme activity?
- (iii) What is a prosthetic group?
- (iv) Define inhibitors of enzyme.
- (v) How does an enzyme accelerate a metabolic reaction?

Q.4. Extensive questions.

1. Describe in detail the mechanism of enzyme action.
2. Give the effect of pH and temperature on the efficiency of an enzyme action.
3. Write a note on inhibitors of enzymes.
4. What is the importance of enzymes in life?

CHAPTER

4

The Cell

Animation 4.1: Plant cell
Source & Credit: Wiki.gcc

The cell can be defined as the structural and functional unit of life. It is the smallest unit that can carry out all activities of life. Cells are building blocks of complex multicellular organisms.

EMERGENCE AND IMPLICATION OF CELL THEORY

Study of cell (cell biology) began with the discovery of cell by Robert Hooke (1665), who reported his work in his famous publication **Micrographia**. He prepared and studied thin sections of cork (of dead plant material) under his self-made compound microscope.

He observed that the cork is composed of minute honey comb like compartments which he termed as Cells (Fig.4.1). According to Hooke, cell is an empty space bounded by thick walls. Very little information was added to this idea in the following century. The work again started in the beginning of 19th century.

Lorenz Oken (1805) a German scientist, believed that "all living beings originate from or consist of vesicles or cells". Jean Baptist de-Lamarck (1809) expressed similar idea and said "no body can have life if its constituent parts are not cellular tissue or are not formed by cellular tissue".

In 1831 Robert Brown reported the presence of nucleus in the cell. Due to this discovery Hooke's idea about the cell as an empty space was changed. It was later established that cell is not an empty space. A German zoologist Theodor Schwann (1839) and a German botanist Schleiden (1838), working independently, came out with a theory called the Cell Theory.

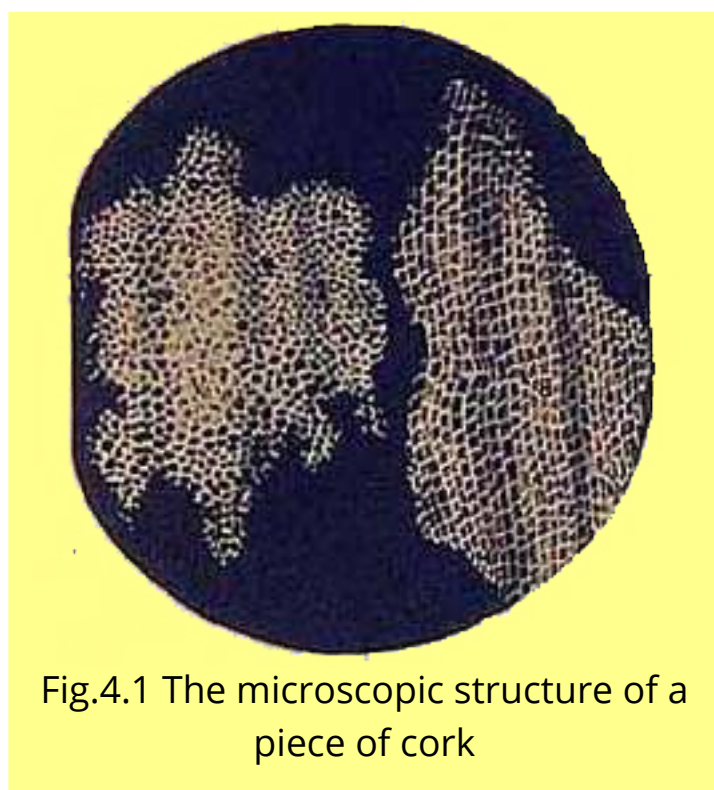

Fig.4.1 The microscopic structure of a piece of cork

They found that the cell consisted of 3 basic parts, viz nucleus, the fluid (cytoplasm) surrounding the nucleus, and an outer thin covering or membrane (plasma membrane). The cell wall, they said, was an additional structure, present only in plant cell. Keeping in view this definition of cell, the cells could be observed in plant as well as in animal; according to cell theory, all living organisms are composed of cells and cell products.

The cell theory is one of the most fundamental generalizations in Biology. It has wide ranging effect in all fields of biological sciences. After the cell theory was presented, many details of cell were studied, as a result of which the cell theory was extended.

Rudolph Virchow (1855), a German physician, hypothesized that new cells were formed only by the division of previously existing living cells (to put it in Virchow's words : "omnis cellula e cellula"). It was contrary to the idea of "abiogenesis" (living things arise spontaneously from non-living things), one of the prevailing but controversial ideas about origin of life, at that time. Louis Pasteur (1862), one of the greatest scientists of all times, supplied experimental proof for Virchow's hypothesis by demonstrating that microorganisms (bacteria) could be formed only from existing bacteria. Original cell theory and Virchow's hypothesis gave us the basis for working definition of living things: living things are chemical organizations composed of cells and capable of reproducing themselves'. August Weismann (1880) said 'all presently living cells have a common origin because they have basic similarities in structure and molecules etc. It was shown that there are fundamental similarities in the chemical composition, metabolic activities and structure, although they differ in many respects. Cells are basically similar but extraordinarily versatile. Cell is not only the structural but also the functional unit of living organisms. So cell theory is a very important unifying concept

The human naked eye can differentiate between two points, which are at least 1.0 mm apart. This is known as resolution of the eye. This resolution can be increased with the aid of lenses. In a typical compound microscope the resolution is 2.0 μm , which is about 500X that of naked eye. A compound microscope is a typical laboratory microscope with at least different magnification powers. The typical ocular lenses could be 5X and 10X, but others also exist. Likewise different types of objective lenses viz. 20X, 40X, 100X etc exist. The magnification power of microscope is determined by multiplying X values of ocular lense and X value of objective lense. Therefore, a microscope with 10X ocular lens and 40X objective lense will have (10X40 = 400X) 400X magnifying power. The resolution will, however, remain the same, which is 500X that of the naked eye. The source of illumination in such microscopes is visible light. In electron microscope the source of illumination is a beam of electrons and the resolution of microscope ranges between 2-4 Angstrom, which make it 500X greater than that of the compound microscope and 250,000X greater than that of the naked eye. This means that two points which are 2-4 Angstrom apart can be differentiated with the help of electron microscope. The revelation of complexity of structure of various cellular organelles is closely linked with the development of microscopy and improvement in the resolution power of the microscope.

The salient features of Cell Theory in its present form are:

- (1) All organisms are composed of one or more cells.
- (2) All cells arise from pre-existing cells.
- (3) Cell is the basic structural as well as functional unit for all organisms.

Cell as a unit of structure and function

A cell is a unit of structure and function in living organisms. In multicellular organisms there is a division of labour among cells. Different cells are specialized for different functions. The function of the organism as a whole is the result of the sum of activities and interactions of different cells and of different components of the cell. In animals e.g., muscle cells contract and relax, nerve cells transmit impulses, gland cells secrete, red blood cells carry oxygen and some stomach cells secrete gastric juice. Similarly in plants xylem cells conduct water and mineral salts from soil to the aerial parts of the plant. Phloem cells translocate food, sclerenchymatous cells give support to the plants, chlorenchymatous cells carry out photosynthesis, parenchymatous cells store surplus food and meristematic cells produce new cells for growth and development of the plant. As they perform different functions they show great variation in shape and size. Despite the structural and functional diversity, the plant cells as well as animal cells have a common plan of organization.

STRUCTURE OF A GENERALIZED CELL

Structure of a cell can be studied under light microscope as well as electron microscope. The modern technology enables us to isolate various components of cells including its organelles by a process of cell fractionation and study their structure and function in detail. During cell fractionation the tissues are homogenized or disrupted with special instruments and the various parts of the cells are separated by density gradient centrifugation. This separation is achieved by spinning the homogenized or disrupted cells in a special medium in a centrifuge at medium speed. The various cellular parts separate out in different layers depending upon their size and weight, and density of the medium. Some cellular components require very high speeds for separation from other parts of the cells. This is achieved through ultracentrifugation.

A cell consists of the following basic components:

1. Plasma membrane, also a cell wall in plant cell.
2. Cytoplasm, containing cell organelles.
3. Nucleus, with nuclear or chromatin material.

In the traditional system of classification all organisms are divided into plants and animals. The cells of plants and animals can be distinguished by the presence or absence of cell wall. Cells of

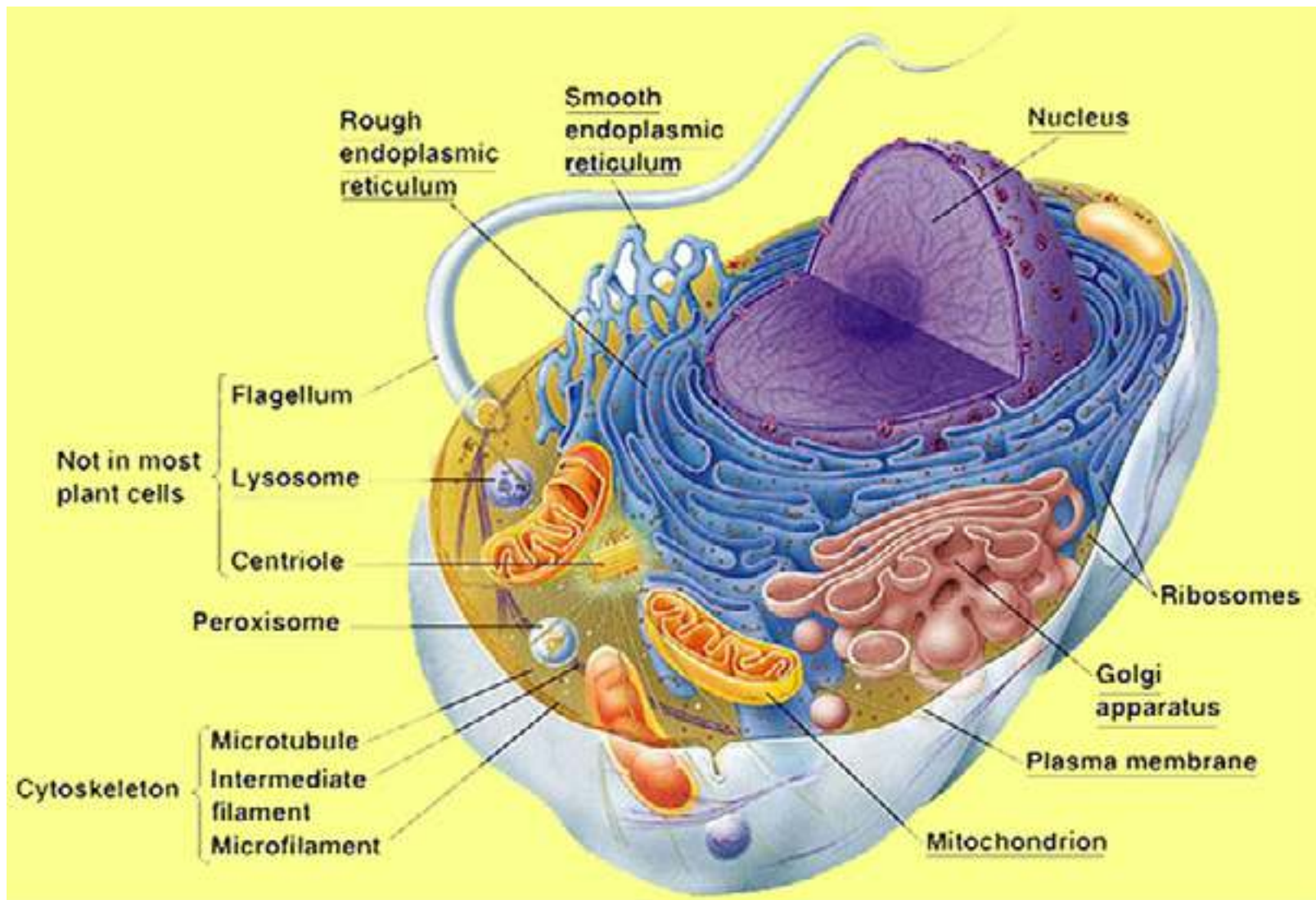

Fig.4.2: Electron microscope structure of a animal cell.



Image 4.2: Structure of Animal Cell
Source and Credit: wikipedia

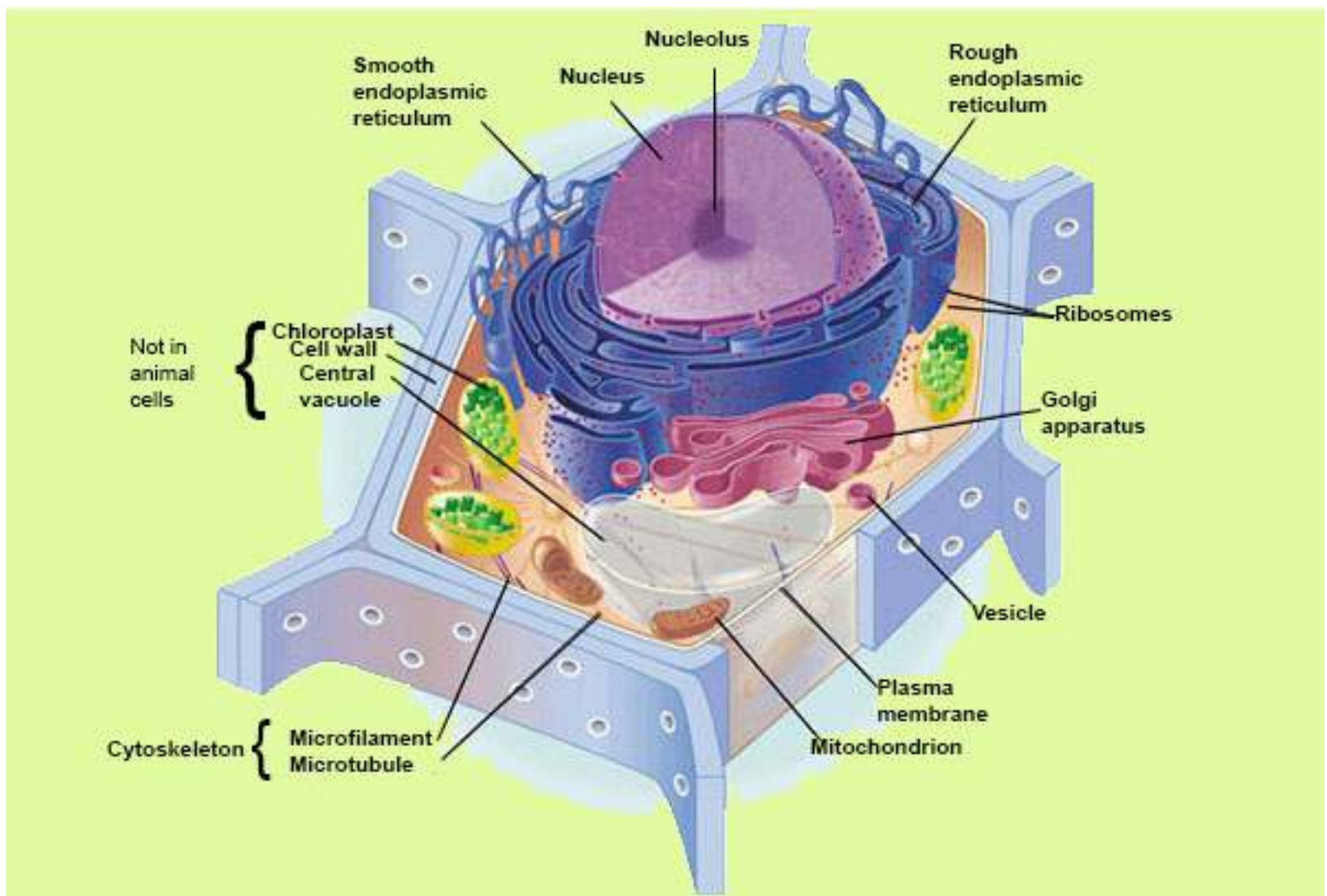

Fig. 4.3 Electron microscopic structure of a plant cell



Image 4.3: Animal Plant Cell
Source and Credit: thegreatestgarden

animals and plants absence of cell wall. Cells of animals and plants are complex and have a distinct nucleus (chromatin material is bounded by a membrane) and are called Eukaryotic. On the other hand, the primitive type of cells, such as bacteria, lack a definite nucleus and are said to be Prokaryotic. In Prokaryotes the nuclear material is directly submerged in the cytoplasm and is not separated from it by membranes.

The eukaryotic cells vary greatly in size. They could be as big as an Ostrich's egg. Most of the cells are microscopic and are not visible to the naked eye. Their size is measured in micrometer (μm). One μm is 0.000,001 meter or 1×10^{-6} of a metre.

The use of modern technology has made it possible to study the following components of the cell in detail (Fig.4.2 and 4.3).

Plasma Membrane

Plasma membrane or cell membrane is the outer most boundary of the cell. However, in most plant cells, it is covered by a cell wall. Cell membrane is chemically composed of lipids and proteins; 60 - 80% are proteins, while 20-40% are lipids. In addition there is a small quantity of carbohydrates.

Many biologists contributed to establish the structural organization of cell membrane. It was proposed earlier that cell membrane is composed of lipid bilayer sandwiched between inner and outer layers of protein (Fig.4.4). This, basic structure is called the **unit membrane** and is present in all the cellular organelles. The modern technology has revealed that lipid bilayers are not sandwiched between two protein layers.

The protein layers are not continuous and are not confined to the surface of the membrane but are embedded in lipid layers in a mosaic manner (Fig.4.5). This discovery led to the proposal of **Fluid Mosaic Model**. This model at present is the most accepted one. Cell membrane also contains charged pores through which movement of materials takes place, both by active and passive transport.

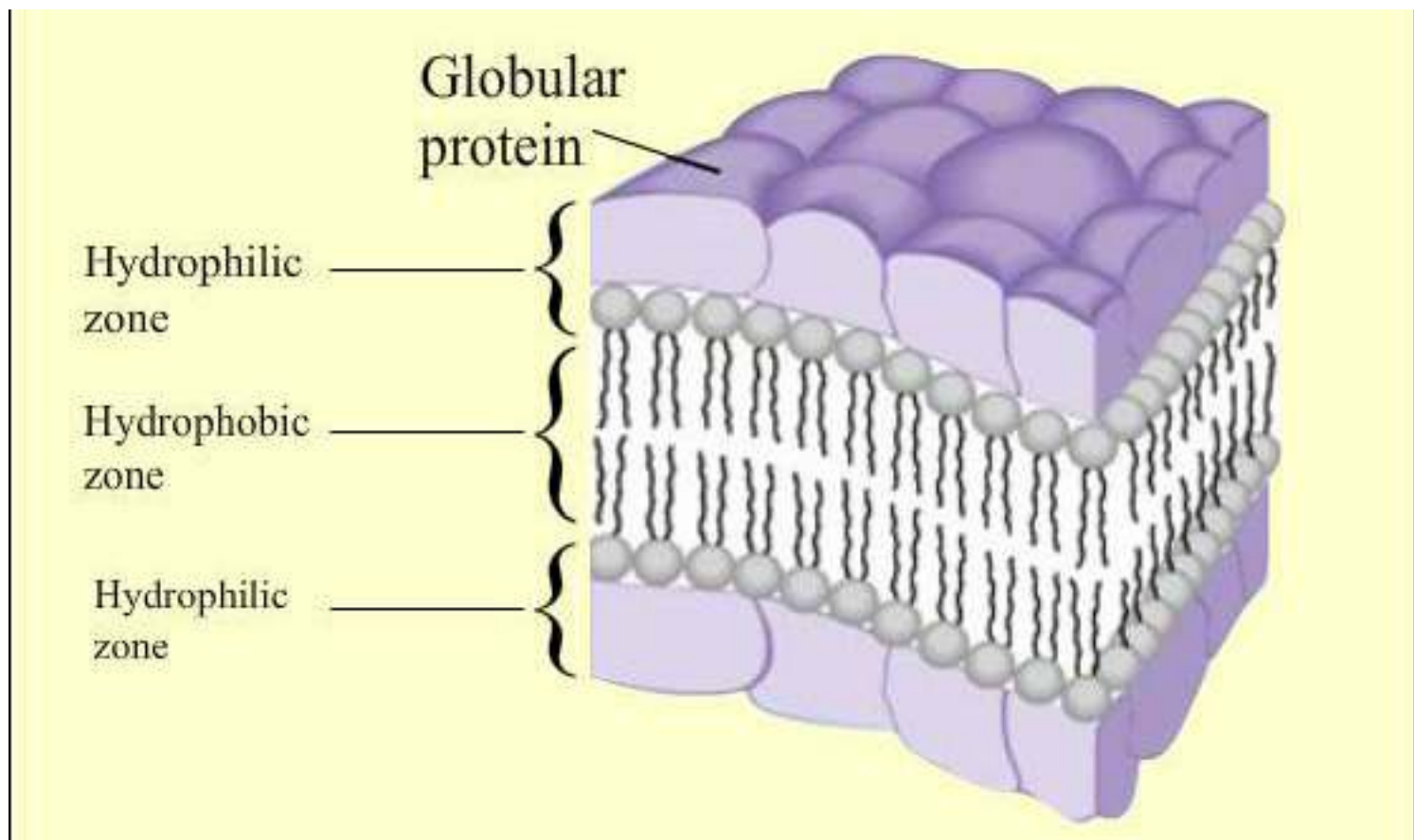

Fig: 4.4. Unit membrane

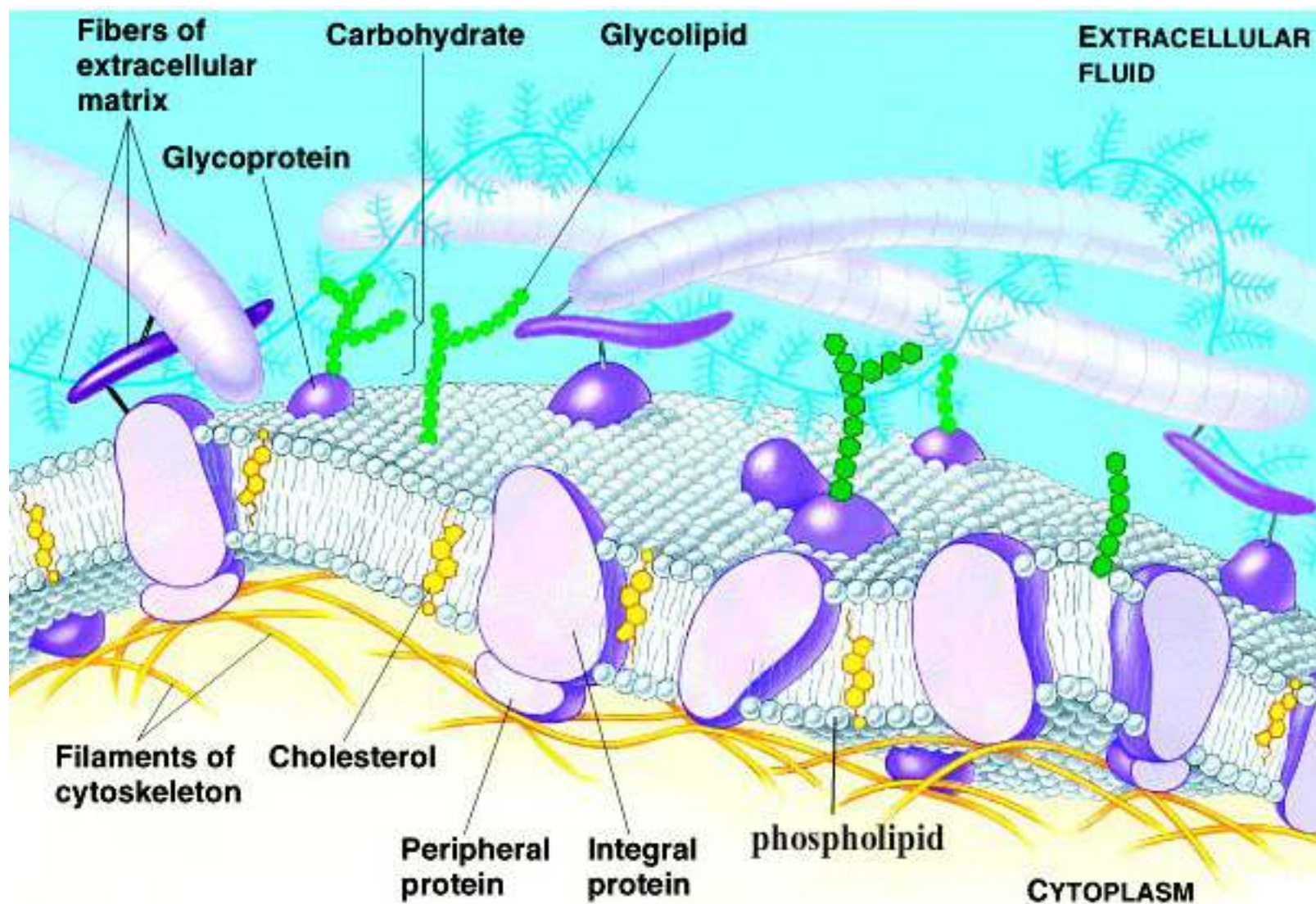

Fig. 4.5. Fluid Mosaic Model

Transport of materials is one of the vital roles it plays for the cell. It offers a barrier between the cell contents and their environment, allowing only selective substances to pass through it, thus it is known as **differentially permeable** or selectively permeable membrane. The substances which are lipid soluble cross it more easily than others, therefore, it regulates the flow of materials and ions to maintain a definite gradient. Many small gas molecules, water, glucose etc. being neutral can easily cross while ions, being charged particles, have some difficulty in crossing. Many substances which are not needed, constantly enter the cell by passive transport, others are taken up against the concentration gradient (they move from the area of low concentration to the area of high concentration). This uphill movement of materials requires energy and is termed as active transport. The energy used for this movement is provided by ATP.

In many animal cells, the cell membrane helps to take in materials by infolding in the form of vacuoles. This type of intake is termed as **endocytosis** which can be either **phagocytosis** (to engulf

solid particles) or **pinocytosis** (to take in liquid material). In neurons (nerve cells) the cell membrane transmits nerve impulses from one part of the body to the other to keep coordination.

Cell Wall

The outer most boundary in most of the plant cells is cell wall. The cell wall of plant cell is different from that of prokaryotes, both in structure and chemical composition. It is secreted by the protoplasm of the cell. Its thickness varies in different cells of the plant. It is composed of three main layers: primary wall, secondary wall and the middle lamella. The **middle lamella** is first to be formed in between the **primary walls** of the neighbouring cells. The primary wall is composed of cellulose and some deposition of pectin and hemicelluloses. Cellulose molecules are arranged in a criss cross arrangement (Fig.4.6). The primary wall is a true wall and develops in newly growing cells. The **secondary wall** is formed on its inner surface and is comparatively thick and rigid. Chemically it is composed of inorganic salts, silica, waxes, cutin lignin etc. Prokaryotic cell wall lacks cellulose; its strengthening material is peptidoglycan or murein. Fungal cell wall contains chitin.

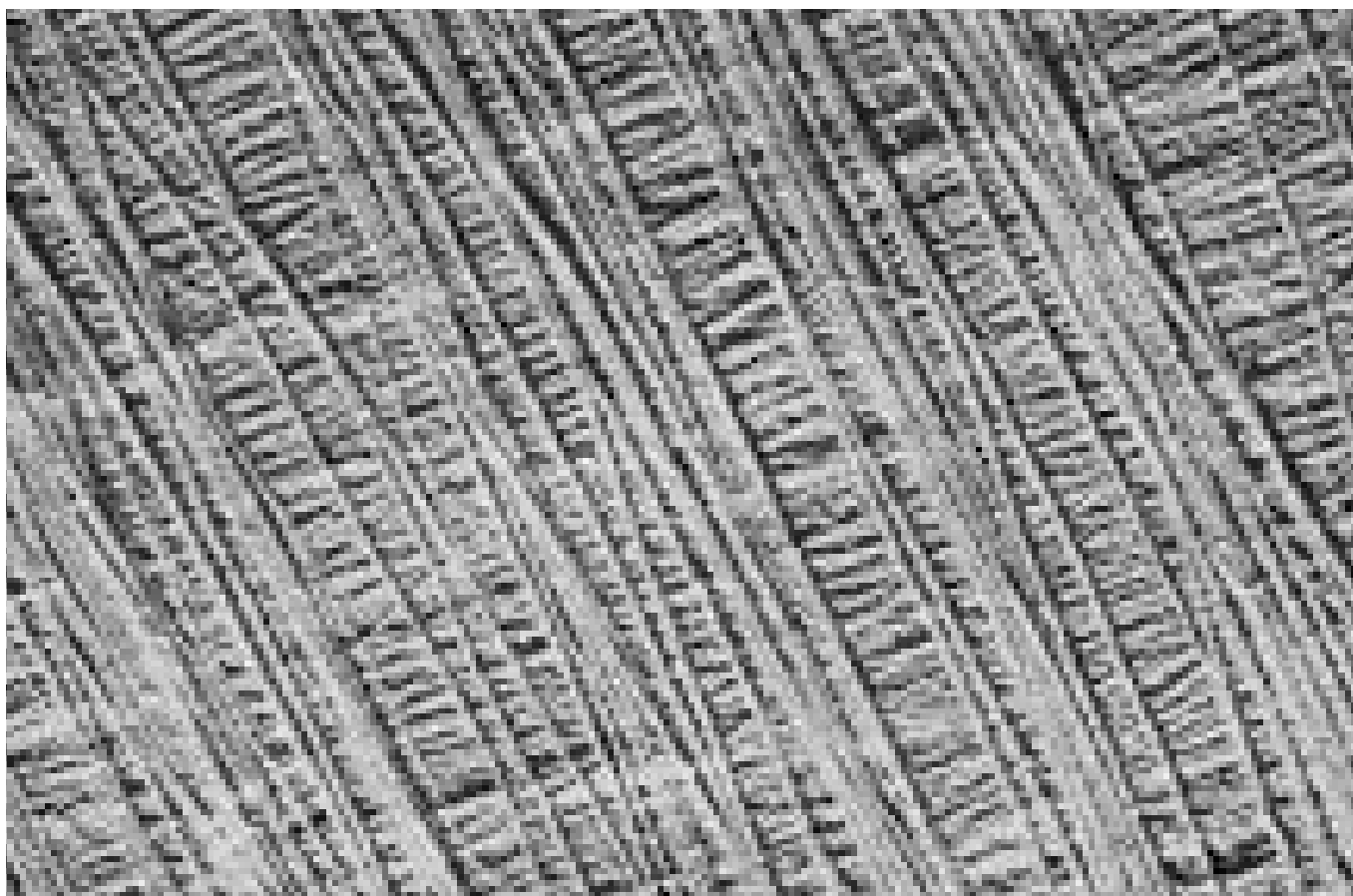
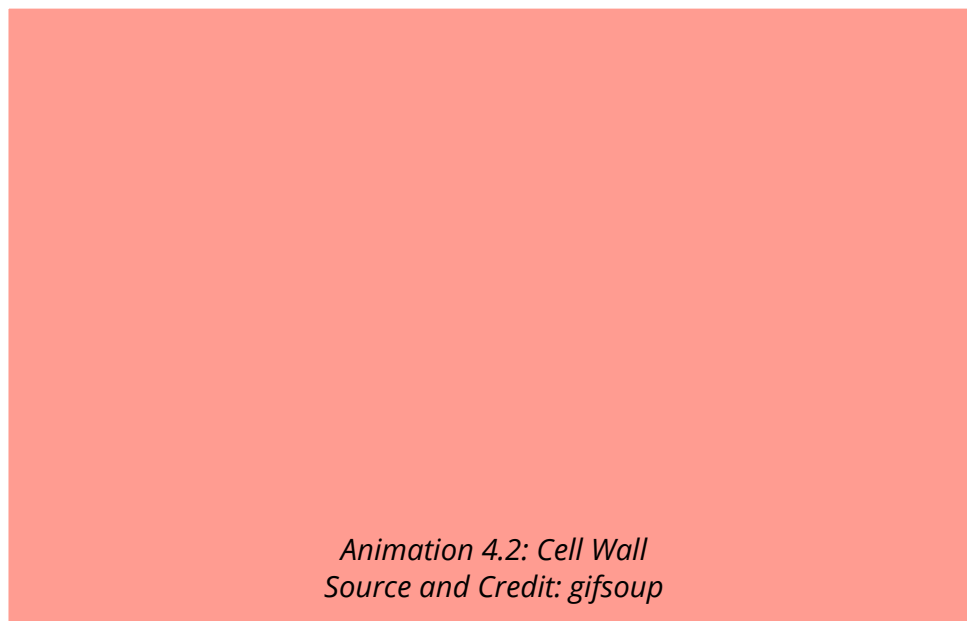

Fig.4.6. Secret of the strength of plant structure is revealed by electron microscope photographs of the cell walls. The cellulose fibers are arranged in layers, with the fibres of each layer at right angle to those of other layers.

Cell wall is very important. It provides a definite shape to the cell and keeps it rigid. It does not act as a barrier to the materials passing through it.



Cytoplasm

The living contents of the eukaryotic cell are divided into nucleus and the cytoplasm, the two collectively form protoplasm. Cytoplasm consists of an aqueous ground substance containing a variety of cell organelles and other inclusions such as insoluble wastes and storage products. The soluble part of the cytoplasm is called **cytosol**. It forms the ground substance of the cytoplasm. Chemically it is about 90% water. It forms a solution containing all the fundamental molecules of life. In the cytosol, small molecules and ions may form true solutions, and some large molecules form colloidal solutions. Colloidal solution may be a **sol** (non-viscous) or a **gel** (viscous). Peripheral parts of the cell are often like a gel.

The most important function of the cytoplasm is to act as a store house of vital chemicals. It is also a site for certain metabolic processes such as glycolysis.

In living cells the cytoplasm contains several cell organelles such as endoplasmic reticulum, mitochondria, Golgi complex, nucleus, plastids, ribosomes, lysosomes and centriole. The free floating cell organelles e.g. mitochondria move about in cytoplasm due to cytoplasmic streaming movements. This is an active mass movement of cytoplasm.

Endoplasmic Reticulum

Under an electron microscope a network of channels is seen extending throughout the cytoplasm. These channels are often continuous with plasma membrane and also appear to be in contact with the nuclear membrane. This entire system of channels is the Endoplasmic Reticulum. These membranes vary widely in appearance from cell to cell. The material present in these channels is separated from the cytoplasmic materials by the spherical or tubular membranes, called **cisternae**.

There are two morphological forms of endoplasmic reticulum; a rough form with attached ribosomes and a smooth form without ribosomes. The rough surfaced endoplasmic reticulum (RER) is involved in the synthesis of proteins.

After synthesis the proteins are either stored in the cytoplasm or exported out of the cell through these channels. The smooth surfaced endoplasmic reticulum (SER) helps in metabolism of a number of different types of molecules particularly lipids. They also help to detoxify the harmful drugs. In some cells SER is responsible for transmission of impulses, e.g. muscle cells, nerve cells. In addition, SER also plays an important role in the transport of materials from one part of the cell to the other. Endoplasmic reticulum also provides mechanical support to the cell so that its shape is maintained.



*Animation 4.3: Rough Endoplasmic Reticulum
Source and Credit: Ameoba sisters*

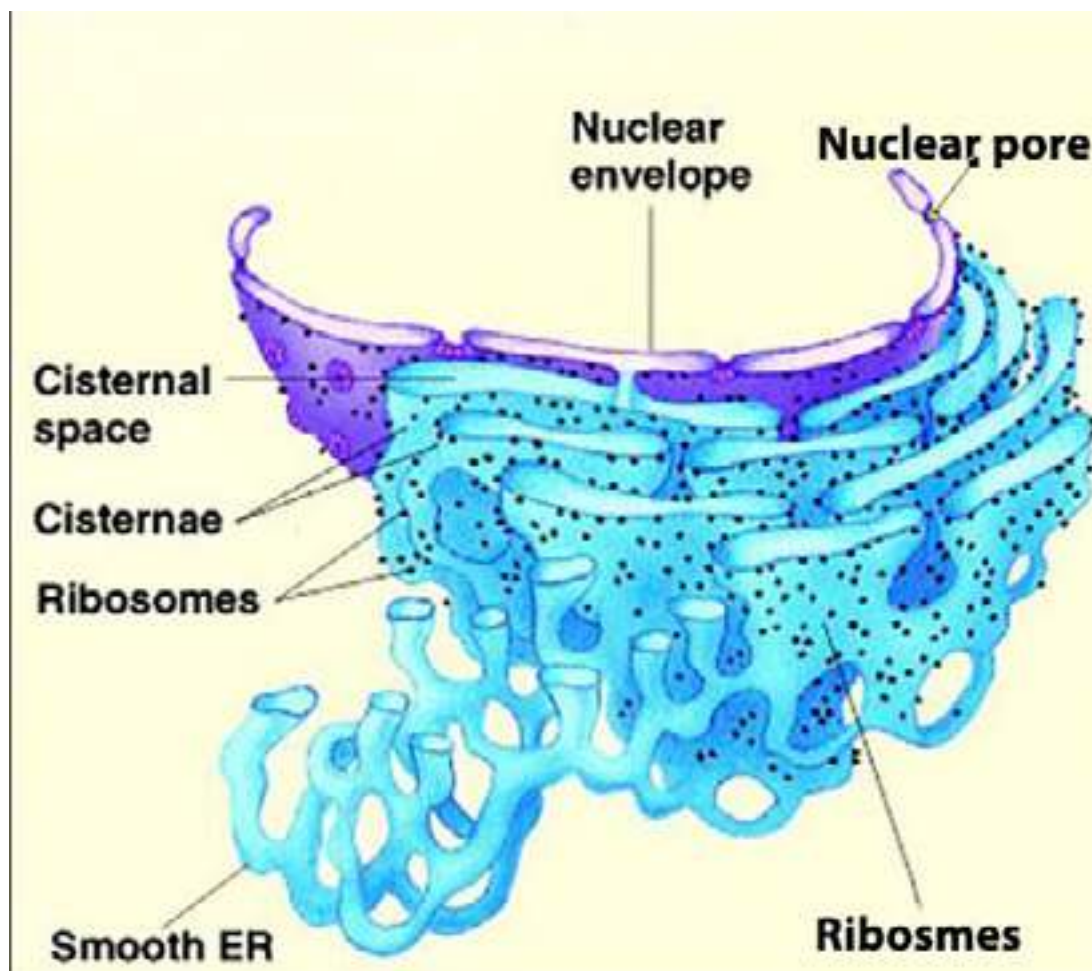

Fig. 4.7: Rough endoplasmic reticulum is marked by the presence of ribosomes attached to the membranes of endoplasmic reticulum. Proteins synthesized on ribosomes are pushed into channels of endoplasmic reticulum, from where they are transported to Golgi Apparatus, on their way out of the cell.

Ribosomes

Cell contains many tiny granular structures known as ribosomes. Palade (1955) was the first person to study them. Eukaryotic ribosomes are composed of an almost equal amount of RNA and protein, hence they are ribonucleo-proteins particles. The RNA present in ribosome is called ribosomal RNA. Ribosomes exist in two forms; either freely dispersed in cytoplasm or attached with RER as tiny granules. Each eukaryotic ribosome consists of two sub-units. The larger subunit sediments at 60S (S= Svedberg unit used in ultracentrifugation), while smaller subunit sediments at 40S. Two subunits on attachment with each other form 80S particle. This attachment is controlled by the presence of Mg^{2+} ions. The ribosomes are attached to messenger RNA through small ribosomal subunit. A group of ribosomes attached to mRNA is known as **polysome** (Fig. 4.8).

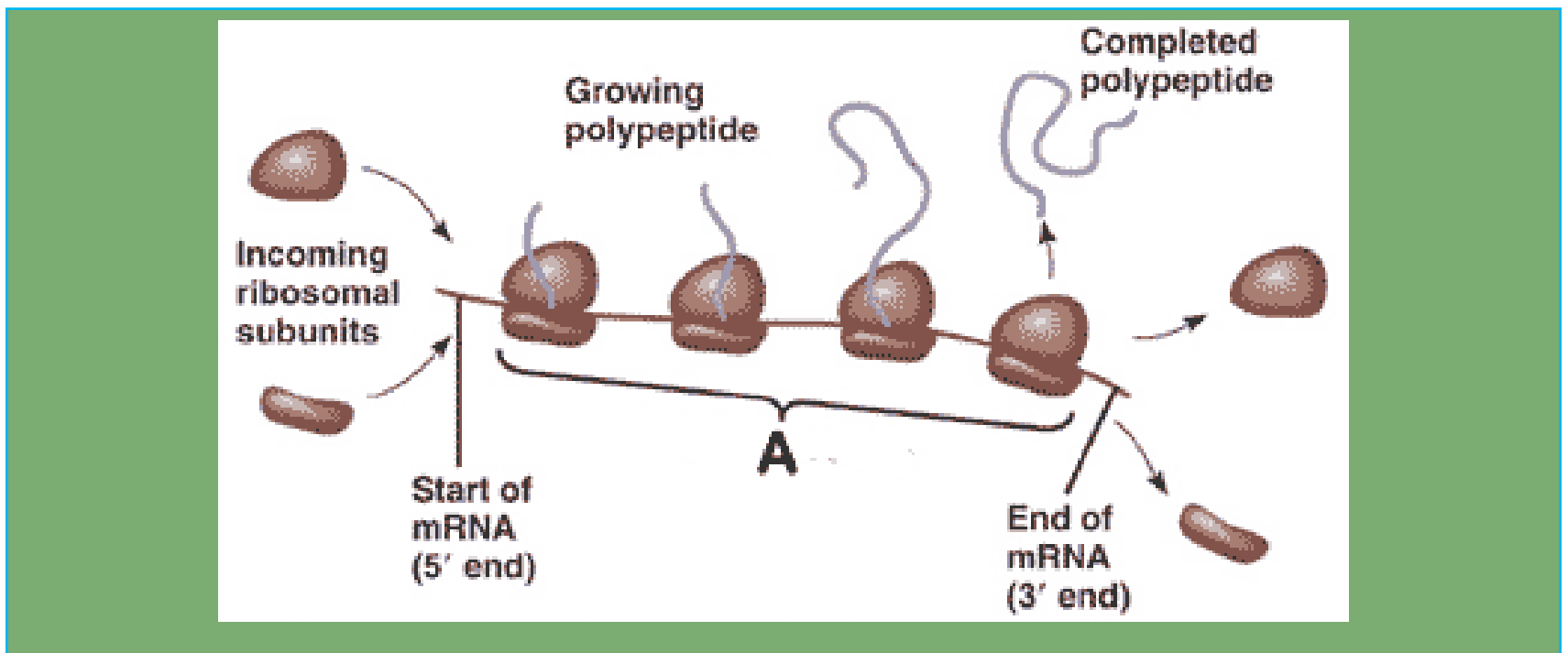
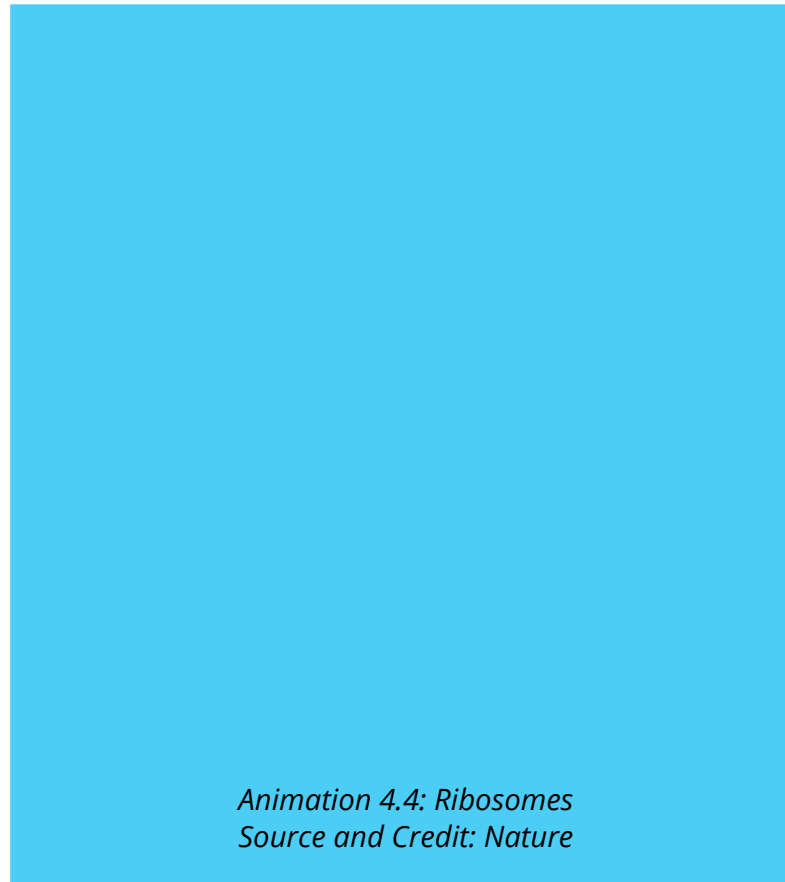
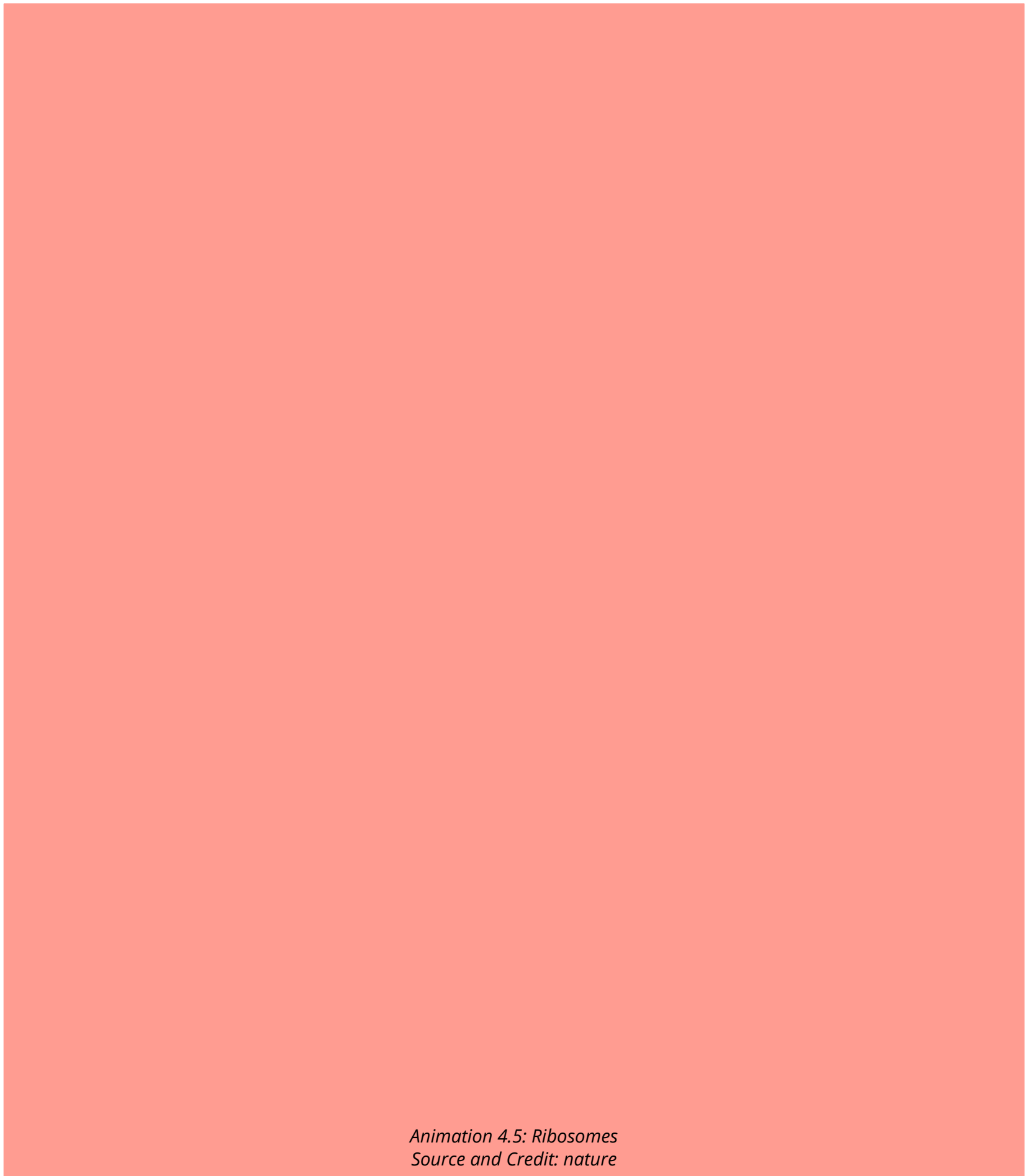

Fig. 4.8 mRNA attached to ribosomes forming polysomes.

New ribosomes are assembled in the nucleolus of the nucleus from where they are transported to the cytoplasm via the pores in nuclear membrane. The factory of ribosome is the nucleolus, while that of protein synthesis is the ribosomes.



*Animation 4.5: Ribosomes
Source and Credit: nature*

Golgi Apparatus

Golgi apparatus was discovered by Golgi in 1898. This apparatus, which was found virtually in all eukaryotic cells, consists of stacks of flattened, membrane bound sacs, called cisternae. These cisternae together with associated vesicles are called Golgi complex. It is a complex system of interconnected tubules around the central stacks. Cisternae stacks are continuously formed by fusion of vesicles, which are probably derived by the budding of SER. Their outer convex surface is the forming face, while the inner concave surface is the maturing face. The cisternae break up into vesicles from the latter. The whole stack consists of a number of cisternae thought to be moving from the outer to the inner face.

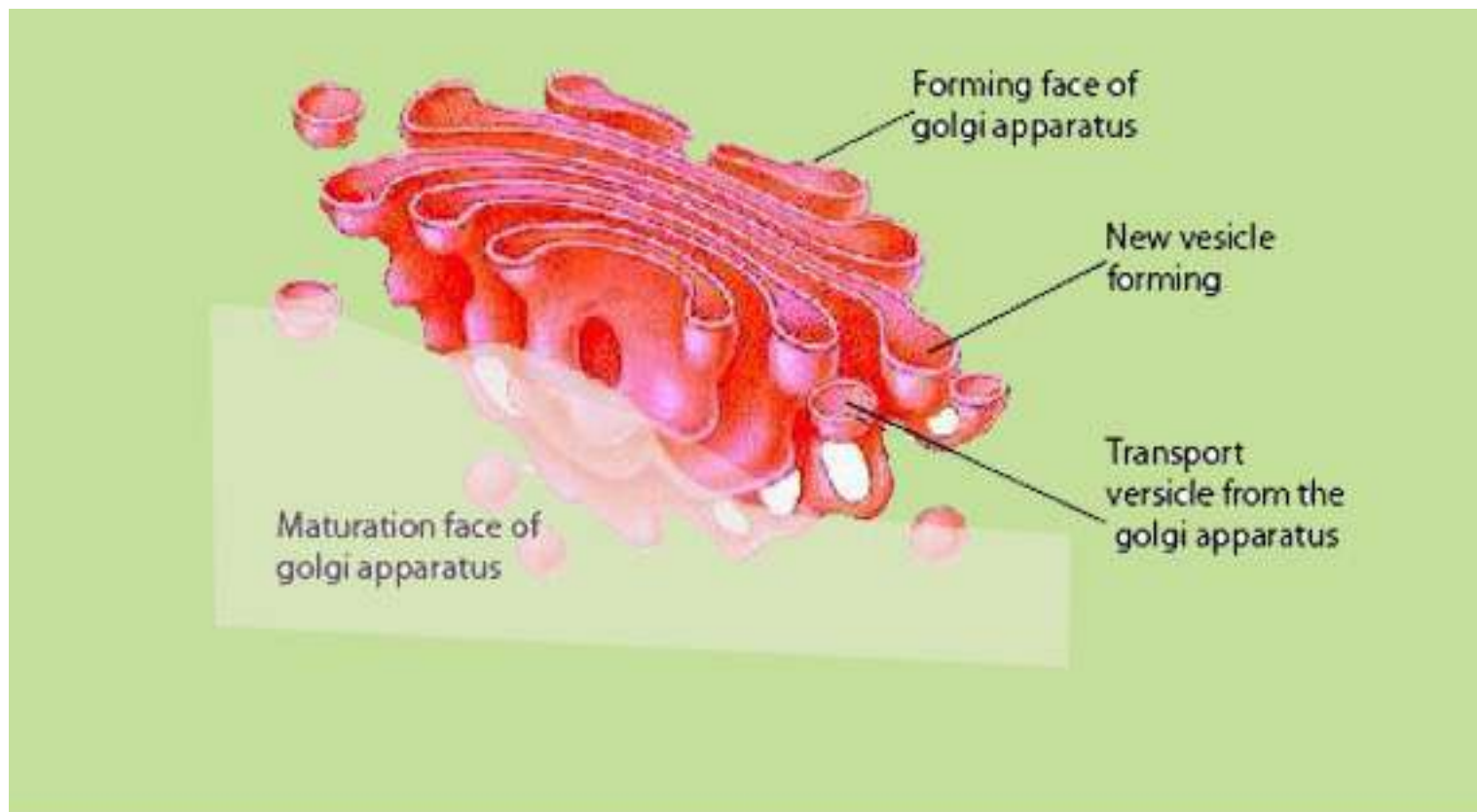

Fig. 4.9 Golgi Complex

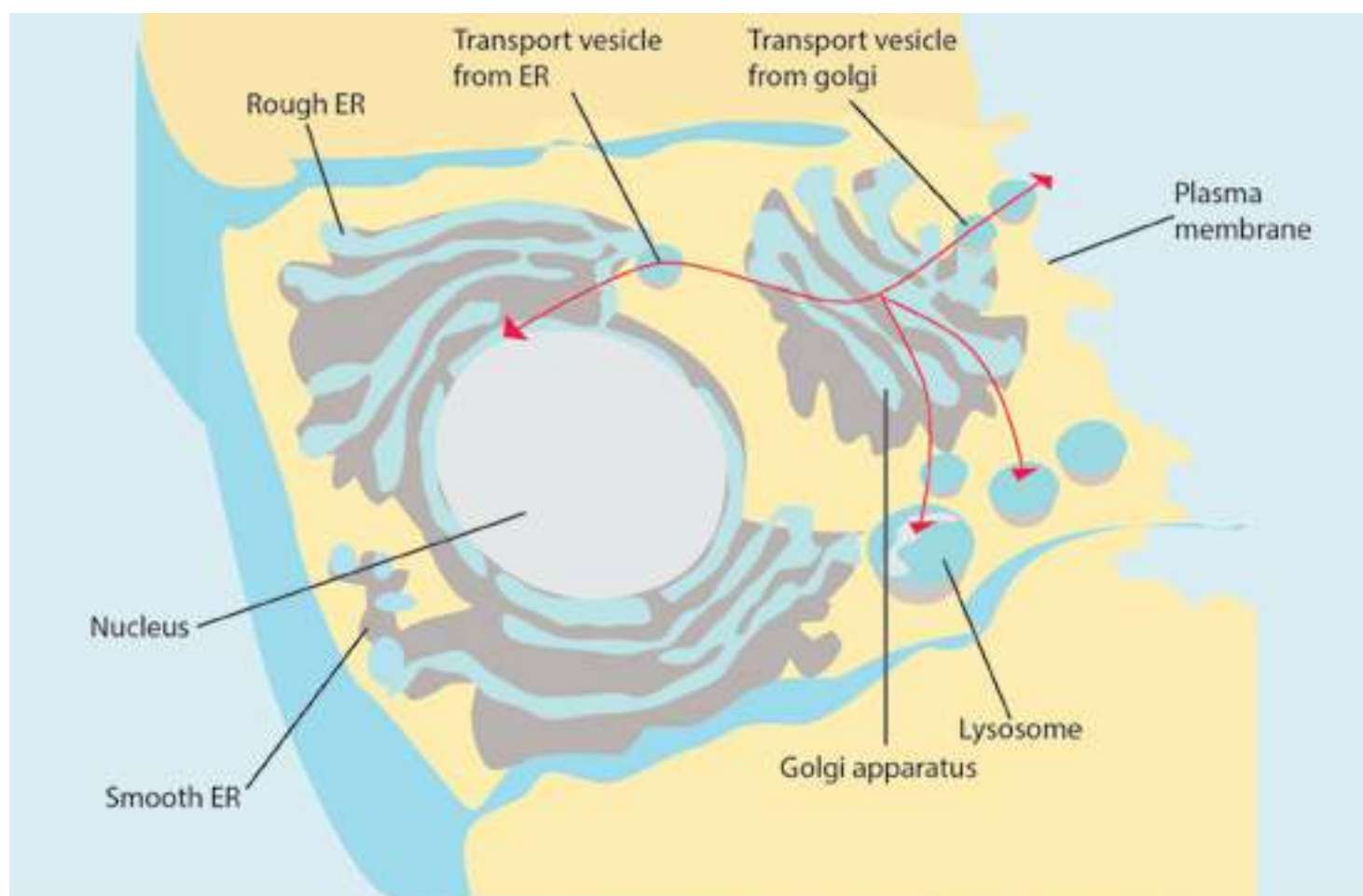

Fig. 4.10. :This figure shows relationship of endoplasmic reticulum with Golgi Apparatus, lysosome and plasma membrane. Golgi Apparatus has two ends, Forming Face and Maturation Face. Blebs from tips of SER fuse with Golgi Apparatus cisternae at Forming Face, whereas secretory granules.

(transport vesicles) are pinched off at the Maturation Face of Golgi Apparatus. The arrows show the direction of flow of protein product synthesized on ribosomes. These proteins are converted into glycoproteins in the Golgi Apparatus.

Golgi complex is concerned with cell secretions. Secretions are products formed within the cell on ribosomes and then passed to the outside through endoplasmic reticulum and Golgi Apparatus. The secretions are converted into finished product and are packed inside membrane, before export. For example in mammals, the pancreas secretes granules containing enzymes that help in digestion. The Golgi complex has a role in formation of these granules. The proteins or enzymes which have to be transported out of the cell pass through the Golgi Apparatus. The most important function of this apparatus is to modify the proteins and lipids by adding carbohydrates and converting them into glycoproteins or glycolipids.



Lysosomes

Lysosomes are cytoplasmic organelles and are different from others due to their morphology. These were isolated as a separate component for the first time by De Duve (1949). Lysosomes (Lyso = splitting; soma = body) are found in most eukaryotic cells. Any foreign object that gains entry into the cell is immediately engulfed by the lysosome and is completely broken into simple digestible pieces. The process is known as phagocytosis (eating process of a cell). They are most abundant in those animal cells which exhibit phagocytic activity. They are bounded by a single membrane and are simple sacs rich in acid phosphatase and several other hydrolytic enzymes. These enzymes are synthesized on RER and are further processed in the Golgi apparatus. The processed enzymes are budded off as Golgi vesicles and are called as primary lysosomes (Fig.4.11). Lysosomes contain those enzymes which can digest the phagocytosed food particles.

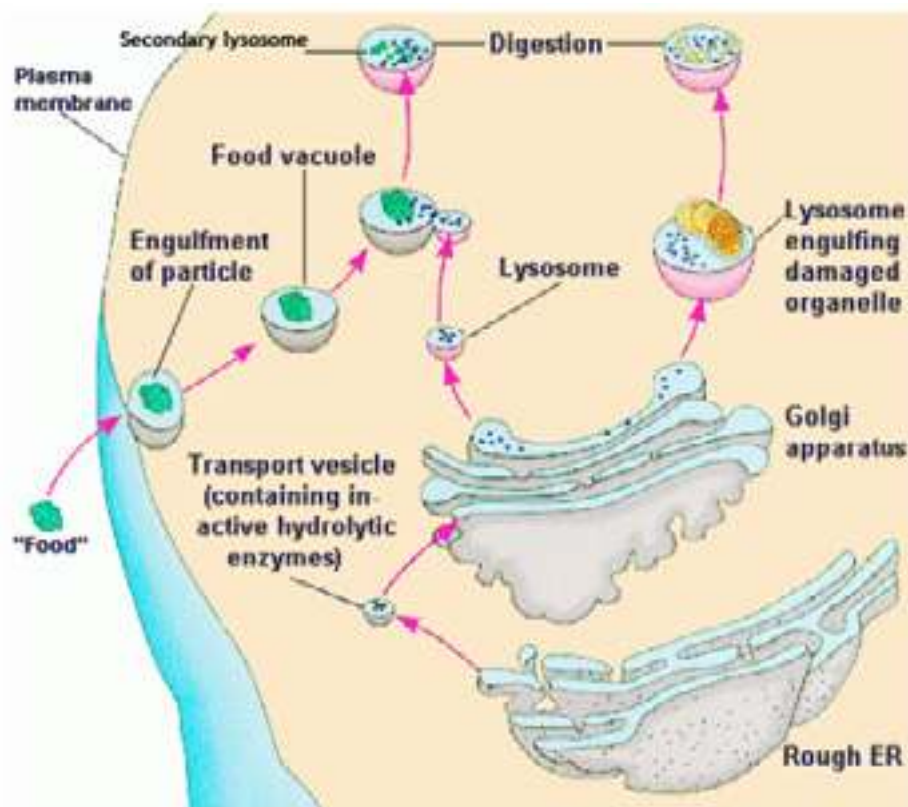
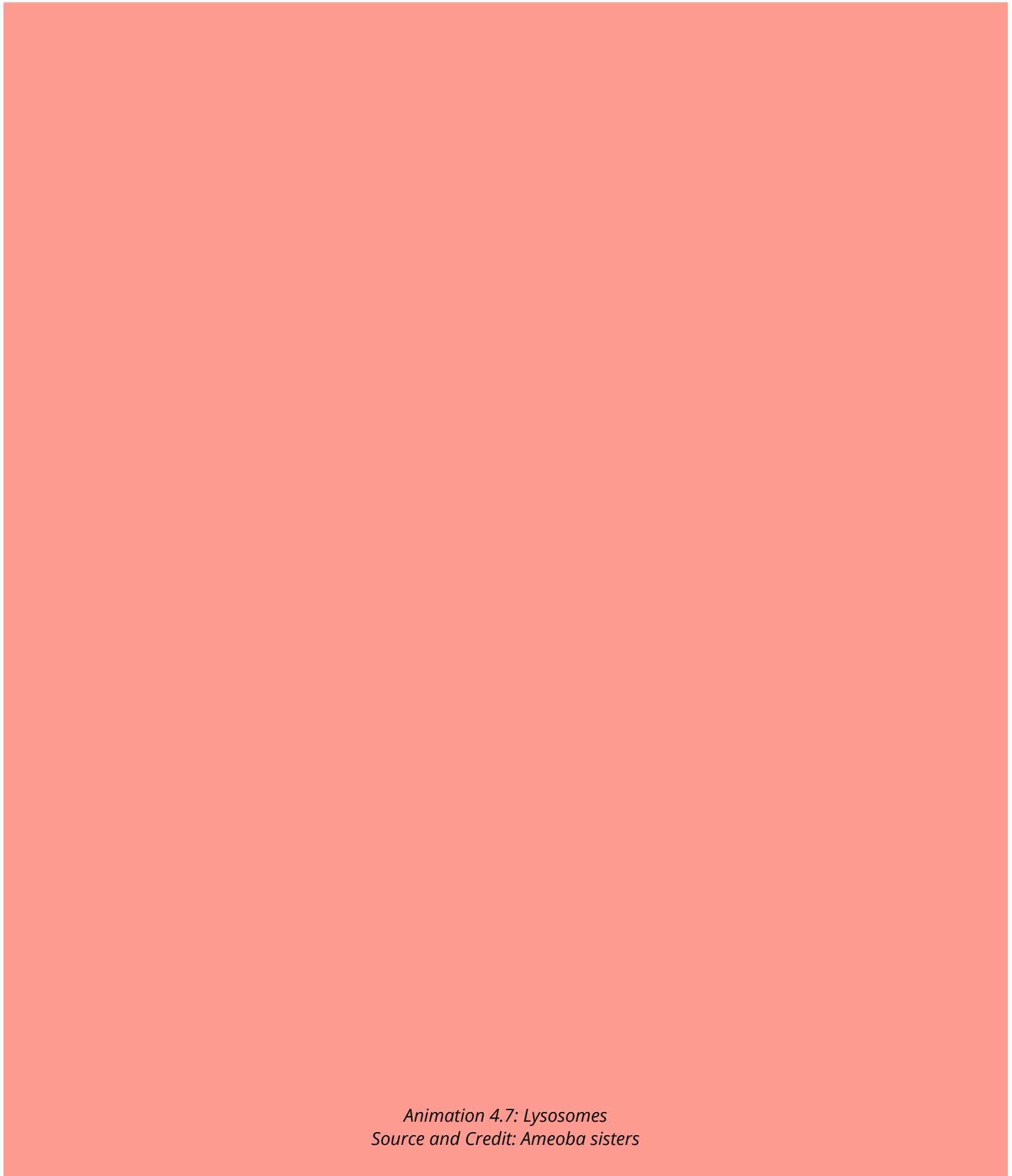

Fig. 4.11: Lysosomes protect the cells from invading organisms or any other foreign object, (food) which are engulfed in the cell as phagocytic vacuoles. These fuse with primary lysosomes to form digestive vacuole (secondary lysosome) in which various lysosomal enzymes digest various.

components of the vacuole. Some times, under abnormal circumstances, e.g. starvation, or as a normal physiological process the parts of the cell are engulfed by primary lysosomes and digested to generate energy. The lysosomes which eat parts of their own cell are known as autophagosomes. The digestive vacuoles and autophagosomes are also known as Secondary Lysosomes.

They are also involved in the autophagy (self eating). During this process some old, worn out parts of cell, such as old mitochondria are digested. In this way, materials of cell may be recycled and cell may be renewed. Their enzymes can also result in degeneration of cell, as may occur during some developmental processes. Lysosomes also release enzymes for extra cellular digestion.

Several congenital diseases have been found to be due to accumulation within the cell of substances such as glycogen or various glycolipids. These are also called storage diseases and are produced by a mutation that effect one of the lysosomal enzymes involved in the catabolism of a certain substance. For example, in glycogenosis type II disease, the liver and muscle appear filled with glycogen within membrane bound organelles. In this disease, an enzyme that degrades glycogen to glucose, is absent. About twenty such diseases are known these days, which are because of absence of a particular enzyme. For example Tay-Sach's disease is because of absence of an enzyme that is involved in the catabolism of lipids. Accumulation of lipids in brain cells lead to mental retardation and even death.



*Animation 4.7: Lysosomes
Source and Credit: Ameoba sisters*

Peroxisome

De-Duve and coworkers isolated in 1965 particles from liver cells and other tissues which were enriched with some oxidative enzymes, such as peroxidase, catalase, glycolic acid oxidase and some other enzymes. The name peroxisome was applied because this organelle is specifically involved in the formation and decomposition of hydrogen peroxide in the cell.

These are single membrane enclosed cytoplasmic organelles found both in animal and plant cells. These are characterised by containing H_2O_2 - producing oxidases and catalase. They are approximately $0.5 \mu m$ in diameter. They have also been found in protozoa, yeast and many cell types of higher plants.

Glyoxysomes

Plants contain an organelle, which in addition to glycolic acid oxidase and catalase also possess a number of enzymes that are not found in animal cells. These organelles, called glyoxysomes are most abundant in plant seedlings, which rely upon stored fatty acids to provide them with the energy and material to begin the formation of a new plant. One of the primary activities in these germinating seedlings is the conversion of stored fatty acids to carbohydrates. This is achieved through a cycle, glyoxylate cycle, the enzymes of which are located in the glyoxysomes.

In plants, peroxisomes play important role in both catabolic and anabolic pathways. In seeds rich in lipids such as castor bean and soyabeans, glyoxysomes are the sites for breakdown of fatty acids to succinate.

This organelle is present only during a short period in the germination of the lipid-rich seed and is absent in lipid-poor seed such as the pea.

Vacuoles

Although vacuoles are present both in animal and plant cells, they are particularly large and abundant in plant cells often occupying a major portion of the cell volume and forcing the remaining intracellular structures into a thin peripheral layer. These vacuoles are bounded by a single

membrane and are formed by the coalescence of smaller vacuoles during the plant's growth and development. Vacuoles serve to expand the plant cell without diluting its cytoplasm and also function as sites for the storage of water and cell products or metabolic intermediates.

The plant vacuole is the major contributor to the turgor that provides support for the individual plant cell and contributes to the rigidity of the leaves and younger parts of the plants.



Cytoskeleton

Cytosol contains cytoskeletal fabric formed of **microtubules**, **microfilaments** and **intermediate filaments**. The main proteins that are present in cytoskeleton are tubulin (in microtubules), actin, myosin, tropomyosin and others which are also found in muscles. Several cell organelles are derived from special assemblies of microtubules, for examples cilia, flagella, basal bodies and centrioles. The movement of cyclosis and amoeboid movements are because of microfilaments, whereas intermediate filaments are involved in determination of cell shape and integration of cellular compartments (Fig. 4.2).

Microtubules are long, unbranched, slender tubulin protein structures. One very important function of microtubules is their role in the assembly and disassembly of the spindle structure during mitosis.

Microfilaments are considerably more slender cylinders made up of contractile actin protein, linked to the inner face of the plasma membrane. They are involved in internal cell motion.

Intermediate filaments have diameter in between those of microtubules & microfilaments. They play role in the maintenance of cell shape.

Centriole

Animal cells, and cells of some microorganisms and lower plants contain two centrioles located near the exterior surface of the nucleus. In cross section each centriole consists of a cylindrical array of nine microtubules. However, each of the nine microtubules is further composed of three tubules (Fig. 4.12). The two centrioles are usually placed at right angle to each other. Just before a cell divides, its centrioles duplicate and one pair migrates to the opposite side of the nucleus. The spindle then forms between them. They are absent in higher plants. Centrioles play important role in the location of furrowing during cell division, and in the formation of cilia.

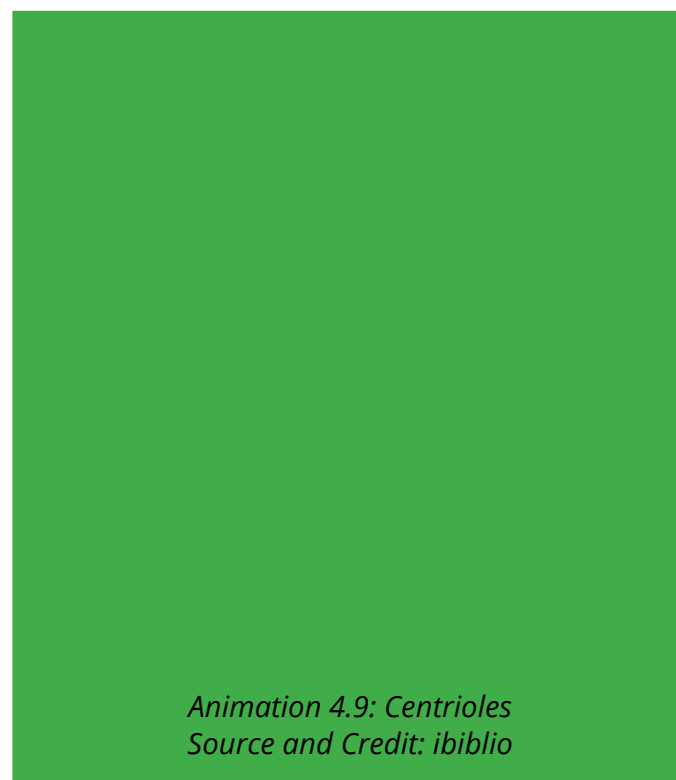



Fig. 4.12. Centrioles are made up of nine microtubule triplets.

Mitochondria

Mitochondria are very important organelles of eukaryotic cells, because they are involved in the manufacture and supply of energy to the cell. They are also known as powerhouses of the cell (Fig. 4.13). Under compound microscope they appear to be vesicles, rods or filaments. Under an electron microscope, they show complex morphology. Although their number, shape and internal structure vary widely, a mitochondrion is bound by two membranes, the outer membrane is smooth, while the inner membrane forms infoldings into the inner chamber called mitochondrial matrix. These infolds are called **cristae**. The mitochondrial membranes are similar in structure to other cell membranes. Detailed studies have shown that mitochondria also contain DNA as well as ribosomes.

The presence of ribosomes and DNA indicates that some proteins are synthesized in them. It is a self replicating organelle.

The inner surface of cristae in the mitochondrial matrix has small knob like structures known as F_1 particles (Fig. 4.13). Mitochondrial matrix contains in it a large number of enzymes, coenzymes and organic and inorganic salts which help in several vital metabolic processes like Krebs's cycle, aerobic

respiration, fatty acid metabolism etc. As a result of these metabolic processes the energy extracted from the organic food is transformed into energy rich compound ATP (adenosine triphosphate), and the ATP then provides energy to the cell on demand. The size and number of mitochondria varies and depends on the physiological activity of the cell.

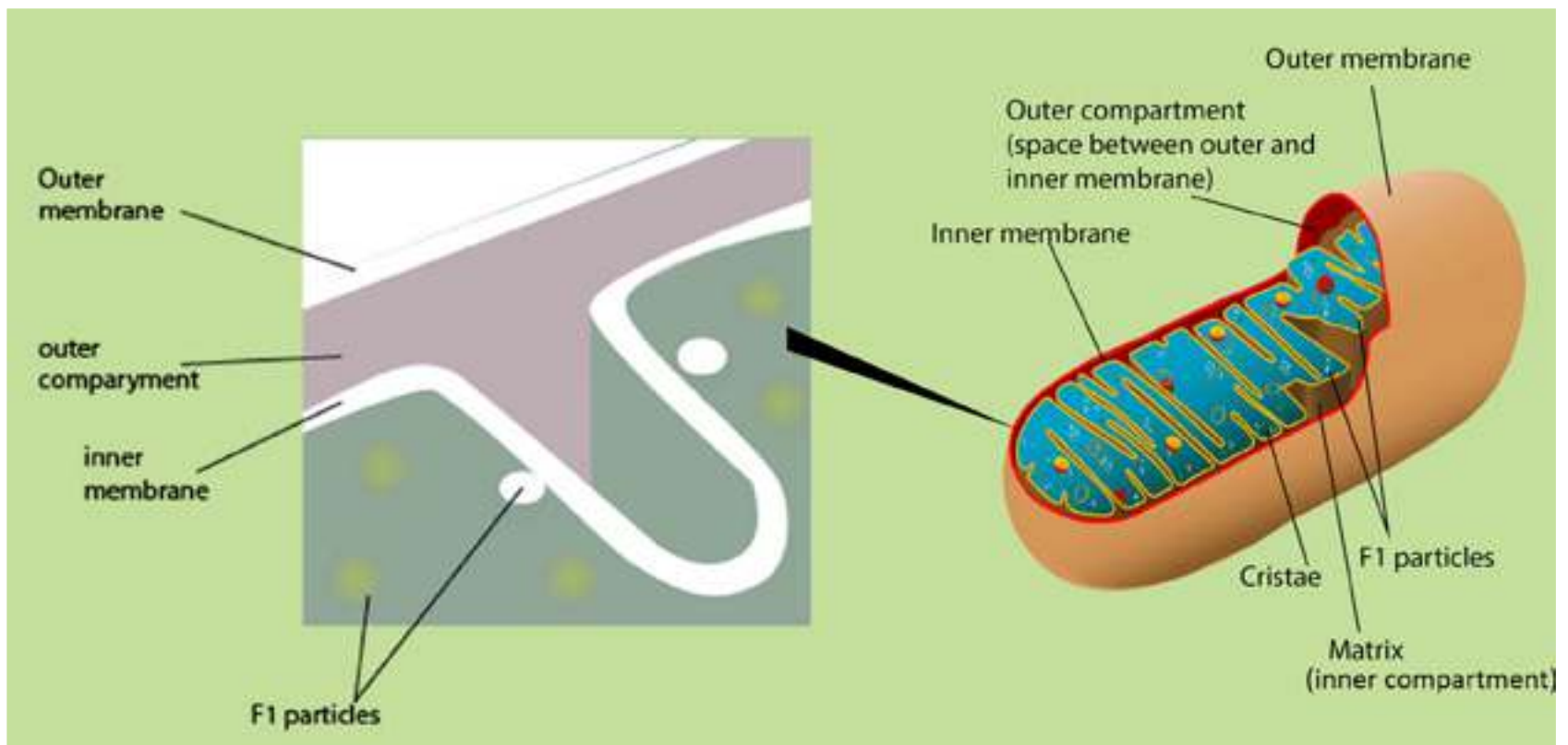
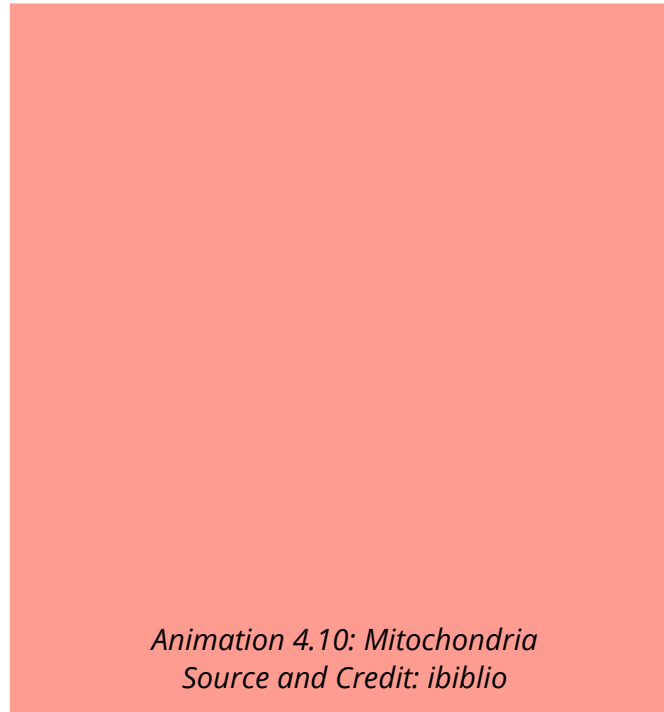

Fig.4.13. : Diagrammatic representation of a mitochondrion cut longitudinally. The main features are shown. A crista is made of lipoprotein membrane containing different enzymes as well as F1 Particles embedded in it. After a special processing the inner mitochondrial membrane is ruptured and the F1 particles come out on the surface.

Mitochondria extract energy from different components of food and convert it in the form of ATP. This energy is used for various cellular activities. The spent energy, which is in the form of ADP is regenerated by the mitochondria into ATP. Mitochondria is therefore described as power house of the cell.



*Animation 4.11: Mitochondrial ATP synthase
Source and Credit: Jon Lund Steffensen*

Plastids

Membrane bound, mostly pigment containing bodies present in the cells are called Plastids. Plastids are present in plant cells only.

There are three main types of plastids.

1. Chloroplasts

In photosynthetic plant cells, there are membrane bound structures containing a green pigment, called chloroplasts. The green pigment is an organic compound, chlorophyll, which helps the cell to absorb light energy and utilize it to manufacture food. Chlorophyll molecule resembles the haem group of haemoglobin, a protein used in the transport of oxygen. The main difference between these two molecules is that chlorophyll has Mg^{++} while haem has Fe^{++} as the central atom.

Chloroplasts vary in their shape and size with a diameter of about 4-6 μm . Under light microscope they appear to be heterogeneous structures with small granules known as **grana** embedded in the matrix. Under electron microscope, a chloroplast shows three main components, the envelope, the stroma and the thylakoid. The envelope is formed by a double membrane, while stroma covers most of the volume of the chloroplast. Stroma is a fluid which surrounds the thylakoids. It contains proteins, some ribosomes and a small circular DNA. It is in this part of the chloroplast where CO_2 is fixed to manufacture sugars. Some proteins are also synthesized in this part. Thylakoids are the flattened vesicles which arrange themselves to form grana and intergrana. A granum appears to be a pile of thylakoids stacked on each other like coins. On an average, there are 50 or more thylakoids piled to form one granum. On the layers of thylakoids chlorophyll molecules are arranged and that is why granum appears to be green (Fig.4.14). Each granum is interconnected with others by the non-green part called intergranum. Membranes of the grana are sites where sun light energy is trapped and where ATP is formed. Chloroplasts are self-replicating organelles.

2. Chromoplasts

They impart colours to the plants other than green. They are present in the petals of the flower and in the ripened fruit. They help in pollination and dispersal of seeds.

3. Leucoplasts

They are colourless. They are triangular, tubular or of some other shape. They are found in the underground parts of the plant and store food.

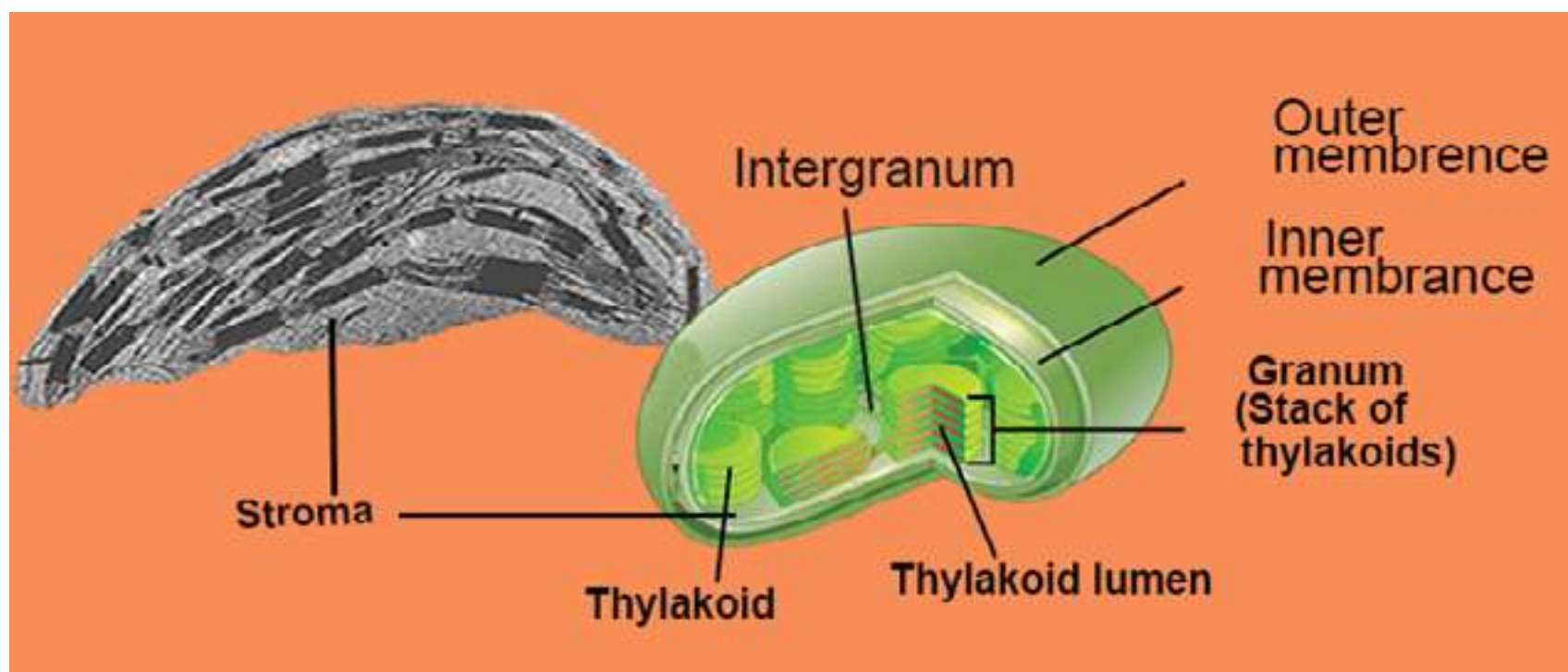

Fig. 4.14: Diagram of chloroplast showing the main structural components.

NUCLEUS

Presence of cell nucleus was reported in 1831 by Robert Brown. Its early discovery was undoubtedly due to its prominence in many cells, where it stands out as slightly darker than the surrounding cytoplasm. It controls the life and activities of the cell. In animal cells, it generally occupies the central space, while in the case of plant cells it is pushed towards periphery due to the presence of a large vacuole. Nucleus may be irregular or spherical in shape. Generally, the cells have one nucleus and are called **mononucleate**. On the other hand, the cells with two nuclei are binucleate and with more than two as multinucleate.

Nucleus is only visible when the cell is in non-dividing stage. It contains **chromatin network** and soluble sap called **nucleoplasm**. In dividing cells, the nucleus disappears and the chromatin material in it is replaced by chromosomes. The heredity material is in the form of chromosomes, which controls all the activities of the cell. DNA, RNA and proteins including enzymes form the chemical composition of the nucleus. Nucleus consists of nuclear membrane, nucleoli, nucleoplasm and chromosomes.

Nuclear Membrane

Nucleus is surrounded by a nuclear membrane which separates the nuclear material from the cytoplasm. The nuclear membrane is actually a nuclear envelope composed of two membranes. The outer membrane is at places continuous with the endoplasmic reticulum, while the inner membrane encloses the nuclear content. The outer and the inner membranes are continuous at certain points resulting in the formation of pores, the **nuclear pores**. The **nuclear pores** allow the exchange of materials between the nucleus and the cytoplasm. The number of nuclear pores is highly variable. The undifferentiated cells (such as eggs) have numerous pores (about 30,000 per nucleus), whereas differentiated cells such as erythrocytes have only 3 or 4 pores/nucleus. Each pore has a definite structure which controls the traffic of substances passing through them (figs. 4.7, 4.10 and 4.16).

Nucleolus

It is a darkly stained body within the nucleus, and is without any membranous boundary to separate it from the rest of the nuclear material. There may be one or more nucleoli in the nucleus. The ribosomal RNA (rRNA) is synthesized and stored in the nucleolus. It is composed of two regions, the peripheral granular area composed of precursors of ribosomal subunits and the central fibrill

area consisting of large molecular weight RNA and rDNA. It is the nucleolus where ribosomes are assembled and are then exported to the cytoplasm via nuclear pores.

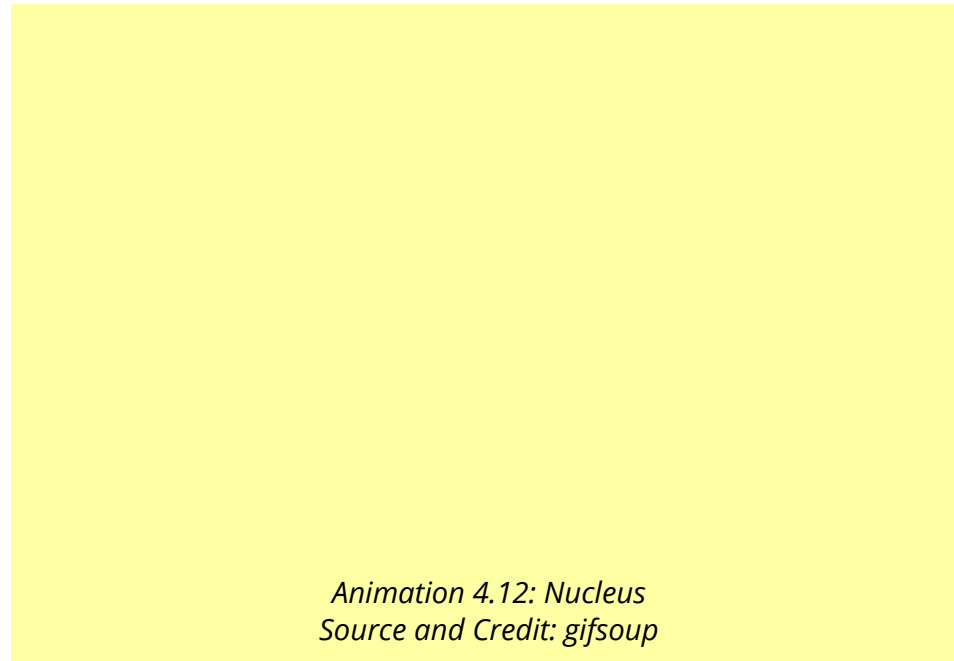

Animation 4.12: Nucleus
Source and Credit: gifsoup

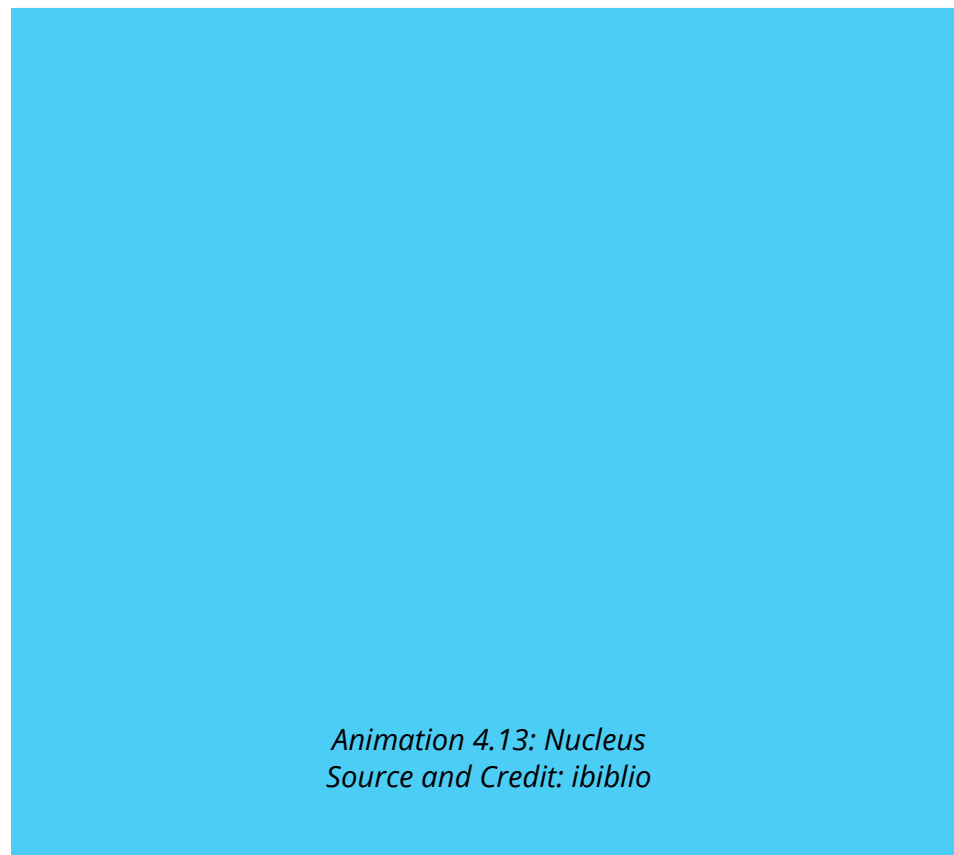

Animation 4.13: Nucleus
Source and Credit: ibiblio

Chromosomes

Nucleus is often deeply stained with basic dyes because of the chromatin material. During cell division chromatin material is converted into darkly stained thread like structures known as chromosomes. Under a compound microscope, chromosomes appear to be made of arms and centromeres. Centromere is the place on the chromosome where spindle fibres are attached during cell division. Each chromosome consists of two identical chromatids at the beginning of cell division (chromatid is exact replica of the chromosome) which are held together at centromere (Fig.4.15).

A chromosome is composed of DNA and proteins. All the information necessary to control the activities of the cell is located on the chromosomes in the form of genes, which are transferred from one generation to the other. The number of chromosomes in all individuals of the same species remains constant generation after generation. In man, each cell contains 46 chromosomes, frog cell has 26 and chimpanzee has 48 chromosomes. There are 8 chromosomes in the fruit fly, *Drosophila melanogaster*, 16 chromosomes in onion, 48 in potato, and 14 in garden pea. The number of chromosomes in normal body cells is diploid ($2n$), whereas haploid chromosome number (n) is present in germ cells, e.g. human sperms and eggs have 23, while those of *Drosophila* have 4 chromosomes.

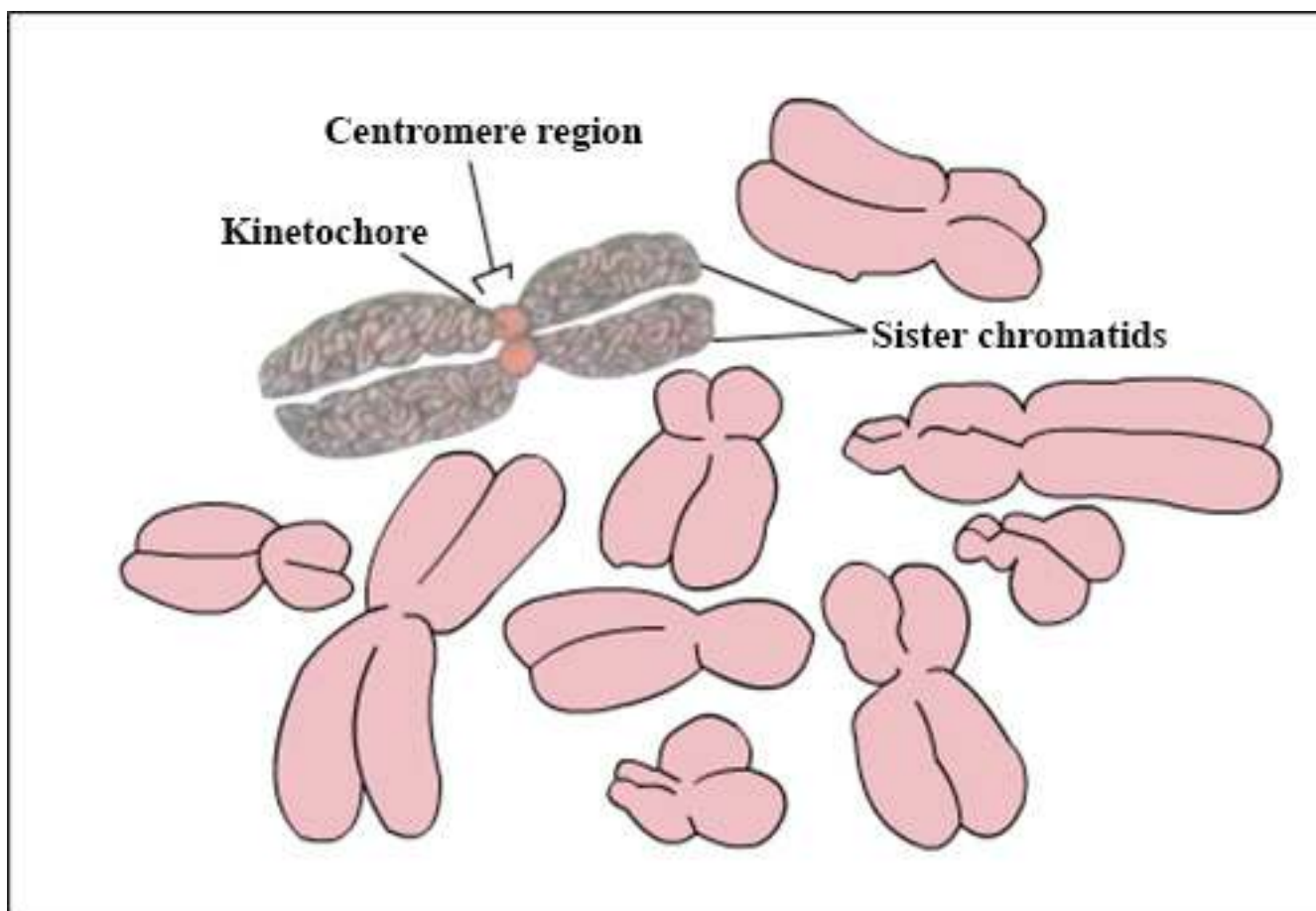

Fig.4.15. : Structure of chromosome and its shape.

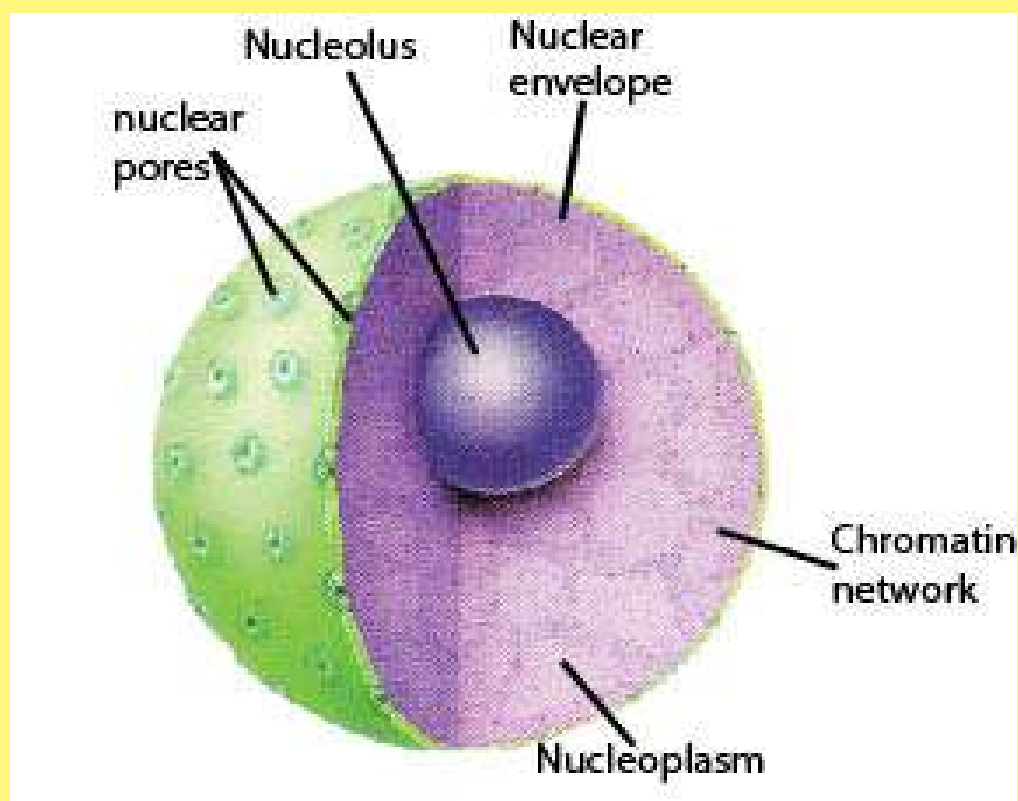

Fig. 4.16 Structure of nucleus

PROKARYOTIC AND EUKARYOTIC CELL

Biologists have divided cells into two types: prokaryotic and eukaryotic. The differences between these two types of cells are mainly based upon the structure of their nuclei. Eukaryotes have a very well defined nucleus, in which nuclear material (chromosomes or DNA) is enclosed in double nuclear membrane. In prokaryotic cells, however the genetic material (DNA) is without any nuclear membrane covering and is directly submerged in the cytoplasm. Organisms possessing prokaryotic cells are called Prokaryotes and those possessing eukaryotic cells are called Eukaryotes. Prokaryotes include bacteria and blue green algae. Eukaryotes include all other unicellular or multicellular organisms such as animals, plants, fungi and protista.

Diagrams of prokaryotic and eukaryotic cells are given in Fig 4.2, 4.3, and 4.17. Prokaryotic cells generally lack many of the membrane bounded structures found in eukaryotic cells. For example, mitochondria, endoplasmic reticulum, chloroplasts and Golgi apparatus are absent in prokaryotic

cells. Since there is no nuclear membrane, a prokaryotic cell has no distinct nucleus and its DNA molecule is directly suspended in cytoplasm. Prokaryotes have small sized ribosomes 70S compared to eukaryotes 80S. In prokaryotes mitosis is missing and the cell divides by binary fission. Because of their simpler structure, it was widely accepted for a long time that prokaryotic cells represent a more primitive stage of evolution than eukaryotic cells. Perhaps the most distinctive feature of the prokaryotic cell is its cell wall, composed of polysaccharide chains bound covalently to shorter chains of amino acids forming peptidoglycan or murein. The entire cell wall is often regarded as a single huge molecule or molecular complex called sacculus. The cell wall of plants is generally made up of cellulose and is differently structured than that of a bacterium.

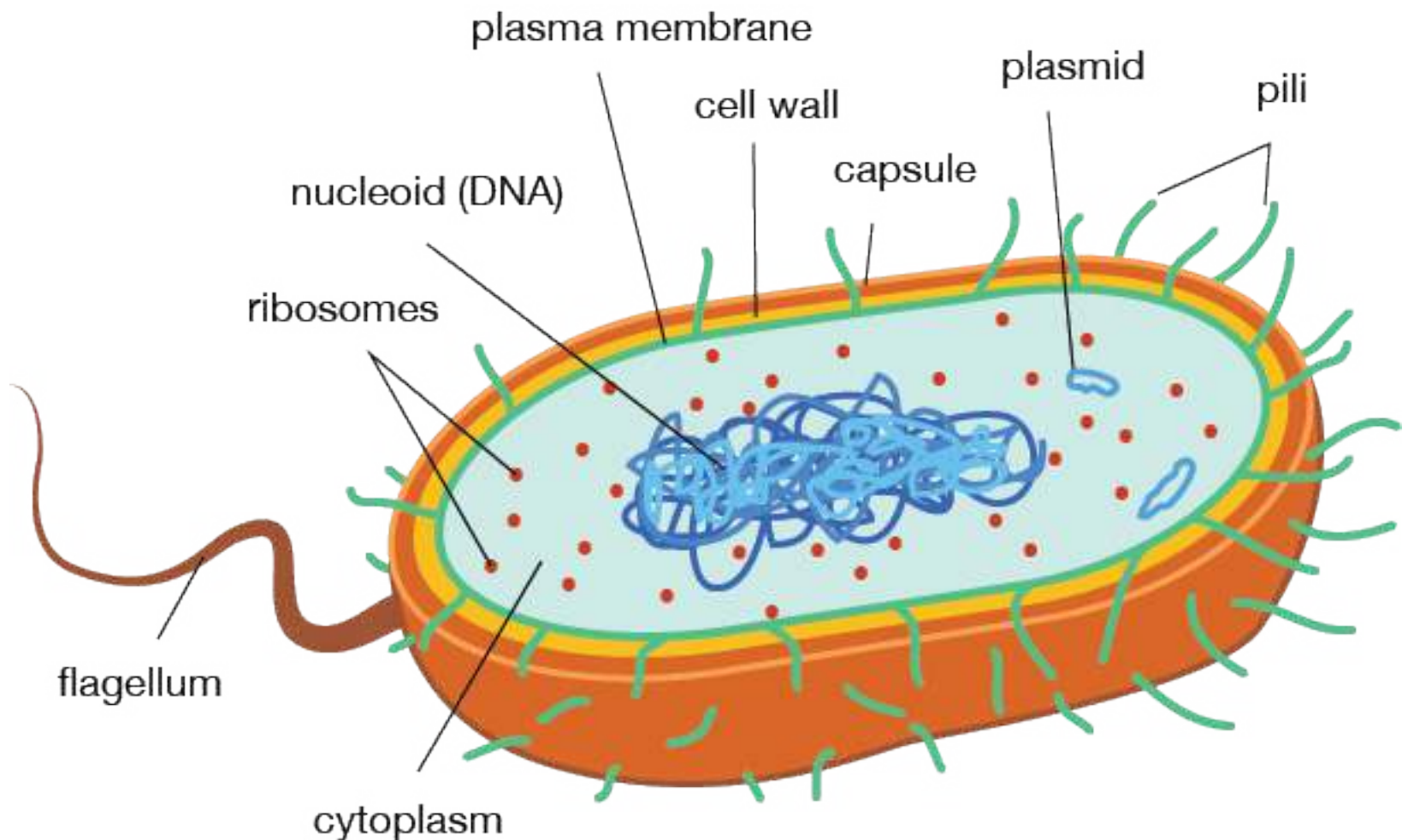
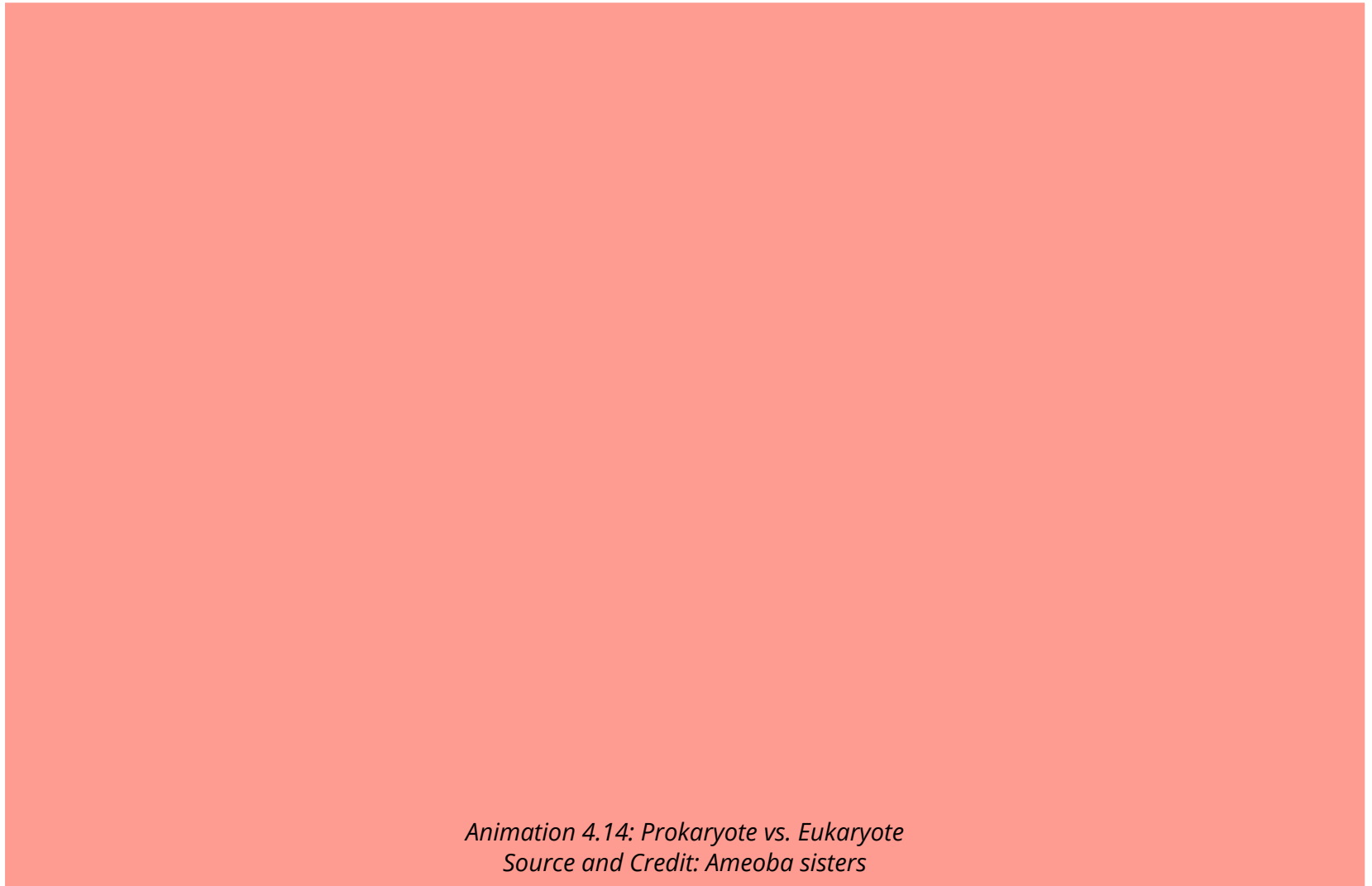

Fig. 4-17. Generalized Prokaryotic cell.



Exercise**Q.1. Fill in the blanks:**

- (i) In eukaryotic cell chromatin material is bounded by -----
- (ii) A group of ribosomes attached to mRNA is known as -----
- (iii) ----- is the place on chromosomes where spindle fibres are attached during cell division.
- (iv) The endoplasmic reticulum with attached ribosomes is known as -----
- (v) The soluble part of the cytoplasm is called.

Q.2. Write whether the statement is 'true' or 'false' and write the correct statement if it is false.

- (i) Cell membrane is present in all eukaryotic cells.
- (ii) Chloroplast and mitochondria do not have hereditary material.
- (iii) Centriole is involved in cell secretions.
- (iv) Sometimes many ribosomes get attached to the same stretch of mRNA forming a structure called the cytosome.
- (v) Mitochondria are very important organelles of the eukaryotic cells.

Q.3. Short Questions.

- i. Describe various movements involved in the transport of materials across the cell membrane.
- ii. State various structural modifications in a cell involved in secretions.
- iii. List the processes blocked by mitochondrial failure in a cell.
- iv. What will happen if a chromosome loses its centromere?
- v. How does autophagy help in converting a tadpole larva into an adult amphibian?
- vi. Is there any similarity between bacterial and plant cell wall?

Q.4. Extensive Questions.

- (i) Compare structure and function of chloroplasts and mitochondria.
- (ii) State 'Cell Theory' and discuss its emergence.
- (iii) Write notes on :
 - (a) Cytoskeleton
 - (b) Peroxisomes & Glyoxysomes
- (v) What might happen if some lysosomal enzymes are absent?
Explain with examples.

CHAPTER



Variety of Life

Animation 5: Virus
Source & Credit: whyfiles

Over one and a half million species of animals and over a half million species of plants are known. To deal with such a large collection of dissimilar forms, certainly we need some system by which species can be classified in a reasonable way. Many types of classifications are possible. We could, for example, classify flowering plants according to their colour, height, or any other character. This type of classification is not meaningful since it does not provide any information about the basic differences and similarities among different individuals.

All organisms are related to one another at some point in their **evolutionary histories**. However, some organisms are more closely related than others. Sparrows are more closely related to pigeons than either to the insects. Classification is based on relationship amongst individuals, that is, similarity in form or structure. Biologists have classified all living things into groups showing similarities, based upon homologies, comparative biochemistry, cytology and genetics. Large groups are divided into smaller groups upto species level. **“A species is a group of natural population which can interbreed freely among themselves and produce fertile offsprings, but are reproductively isolated from all other such groups in nature”**. However “interbreeding” cannot be used as a criterion for species recognition among predominantly asexually reproducing organisms. Each species possessed its own distinct structural, ecological and behavioral characteristics, hence species are independent evolutionary units. Different species do not exchange genes between them. Since long the living things are divided in two **kingdoms: plants** and **animals**. Next each kingdom is divided into smaller groups called phyla (also divisions for plants, algae and fungi).

A phylum, in turn, is divided into **classes**, classes into **orders**, and an order into **families**. A family contains related **genera**, and a genus is composed of one or more **species**. Species is the basic unit of classification. Conversely speaking, the organisms are grouped into larger, more inclusive categories (taxa), each category is more general than the one below it and has emergent properties. The taxonomic categories from species to kingdom form a hierarchy as described in the classification of corn.

Biological classification of Corn, Zea mays

Kingdom.....	Plantae
Division (Phylum).....	Anthophyta (Tracheophyta)
Class	Angiospermae
Order	Poales
Family	Poaceae
Genus	Zea
Species	mays

Members of a lower category resemble one another more than do the members of a higher taxon.

NOMENCLATURE

From the earliest times plants and animals have been given common names by the people. Since no system was used in choosing common names, in many cases, various regions had their own names for the same plant or animal. Take 'Onion' for example; its common urdu name is 'Piyaz' but in different regions of Pakistan it is also known as 'ganda' or 'bassal' or 'vassal'. In different countries it would have another set of names. Similarly 'amaltas', 'argvad', 'gurmala', 'golden shower', 'purging cassia' are common names for the same plant. Thus the same plant may have different names. In some cases, a single name refers to several different plants or animals. What is 'blue bell'? Dozen of plants with bell shaped flowers are called '**blue bells**'. Similarly the word '**black bird**' would mean a crow as well as a raven. Common names have no scientific basis. To a biologist, a fish is a vertebrate animal with a backbone, fins and gills. But 'silver fish' is an insect, and a 'cray fish', 'jelly fish' and 'starfish' do not fit the biologist's definition of a fish.

Common names had long caused confusion. During the 18th century, Carlous Linnaeus (1707-1778), a Swedish botanist, devised a system for naming and classifying all the organisms known to him. His system is used today internationally. He discarded the common names of **plants** and gave each one a scientific name. He took the scientific name from Latin word. Linnaeus publishes the list of names of plants in 1753. The scientific name of each plant had two parts. Usually, the name referred to some characteristics of the organisms or the person who collected it. His system spread rapidly and became so popular that he used it later on in naming **animals** and published his list in 1758. Many of his names are in use today.

Linnaeus's system of giving each species a scientific name comprising two words is known as **binomial nomenclature**. The first name refers to the **genus** (pl. genera) and is called generic name and always begins with a capital letter. The **specific** name follows the generic name and begins with small letter. Scientific name for onion is *Allium cepa*, for amaltas *Cassia fistula* and for man *Homo sapiens*. Botanical name for potato is *Solanum tuberosum* and for brinjal *Solanum melangena*. The same generic name for potato and brinjal reflects close relationship between these two-species. Every specie has only one scientific name the world over. Initially the classification was based on the appearance or **morphology** of plants and animals but with advancement in the knowledge of cytology, physiology, genetics and molecular biology the classification of organism has been modified.

TWO TO FIVE KINGDOM CLASSIFICATION SYSTEMS

Different classification systems recognize two to six kingdoms. For centuries, the living organisms have been classified into two kingdoms, **plants** and **animals**. Plants can prepare their own food from simple inorganic material and store energy (**autotrophs**), while animals can not synthesize their own food from simple inorganic material and depend for their food either on autotrophs or on decaying organic matter (**heterotrophs**). Bacteria were included in plants. Many biologists found this system satisfactory, while others found it unworkable for many unicellular organisms like Euglena that have both plant like (presence of chlorophyll) and animal like (lack of cell wall) characters and also because it ignores the differences between prokaryotic and eukaryotic cells. In 1866, Ernst Haeckel proposed a third kingdom protista to accommodate Euglena like organisms and bacteria. In 1937, E-Chatton suggested differentiating terms **procariotique** (from Greek pro, meaning before, and karyon, meaning nucleus) used to describe bacteria and blue-green algae, and the term **eu-cariotique** (from Greek eu, mean true) to describe animal and plant cells. Some biologists also disagree about the classification of **fungi**, such as bread mold, yeast and mushrooms, which resemble plants in many ways but are not autotrophs. Fungi are special forms of heterotrophs that obtain energy and structural material by breaking down (**decomposing**) and **absorbing** food substances from the surroundings, and possess chitin as a major structural component in their cell walls.

A relatively recent system of classification, the five kingdom system, was proposed by Robert Whittaker (1969). This system of classification shown in Fig 5.1 is based on three different levels of cellular organization associated with three principal modes of nutrition- **photosynthesis**,

absorption and **ingestion**. The five kingdoms proposed (i) the prokaryotic unicellular organisms (**Monera**) such as bacteria, (ii) the eukaryotic predominantly unicellular organisms (**Protista**) such as *Euglena* and *Amoeba*, (iii) the eukaryotic multicellular autotrophs (**Plantae**), (iv) the eukaryotic multicellular reducers (Fungi) for example mushrooms and (v) the eukaryotic multicellular consumers (Animalia). Plants are autotrophic in nutritional mode, making their own food by photosynthesis such as mosses, ferns, flowering plants. Fungi are heterotrophic organisms that are absorptive in their nutritional mode. Most fungi are decomposers that live on organic material, secrete digestive enzymes and absorb small organic molecules which are produced by digestion. Animals live mostly by ingesting food and digesting it within specialized cavities. They lack cellulose and show movements for example birds and reptiles. In five kingdom classification, all eukaryotes that did not fit the definition of plants, fungi or animalia were included in Protista. Most Protists are unicellular forms, but this kingdom also includes relatively simple multicellular organisms that are believed to be direct descendants of unicellular protists.

Lynn Margulis and Karlene Schwartz (1988) modified five kingdom classification of Whittaker by considering cellular organization, mode of nutrition, cytology, genetic and organelles of symbiotic origin (mitochondria, chloroplast). These five kingdoms are **Prokaryotae** (Monera), **Protoctista** (Protists), **Plantae**, **Animalia** and **Fungi** (Fig 5.1).

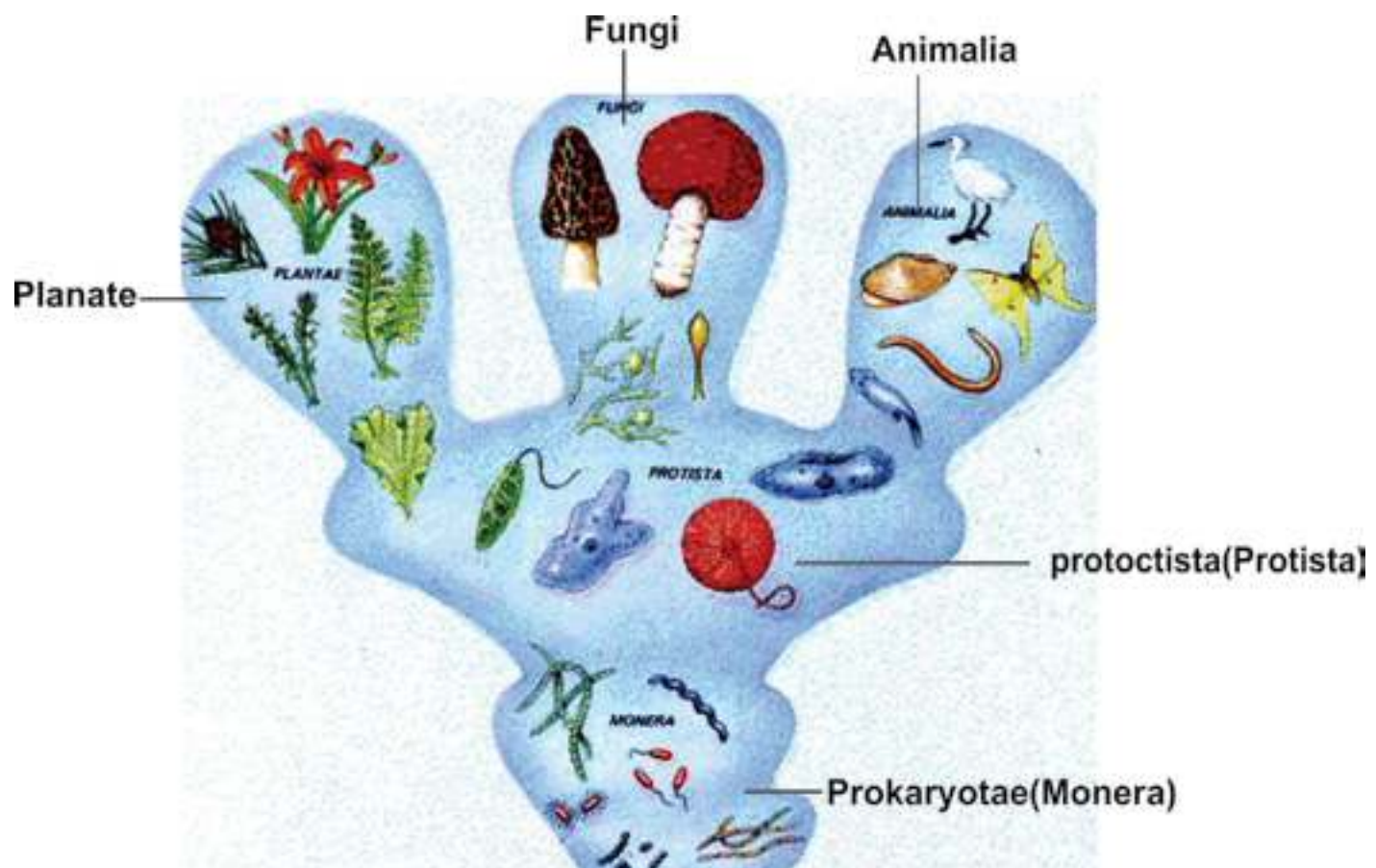

Fig 5.1 Relationship of Five kingdom

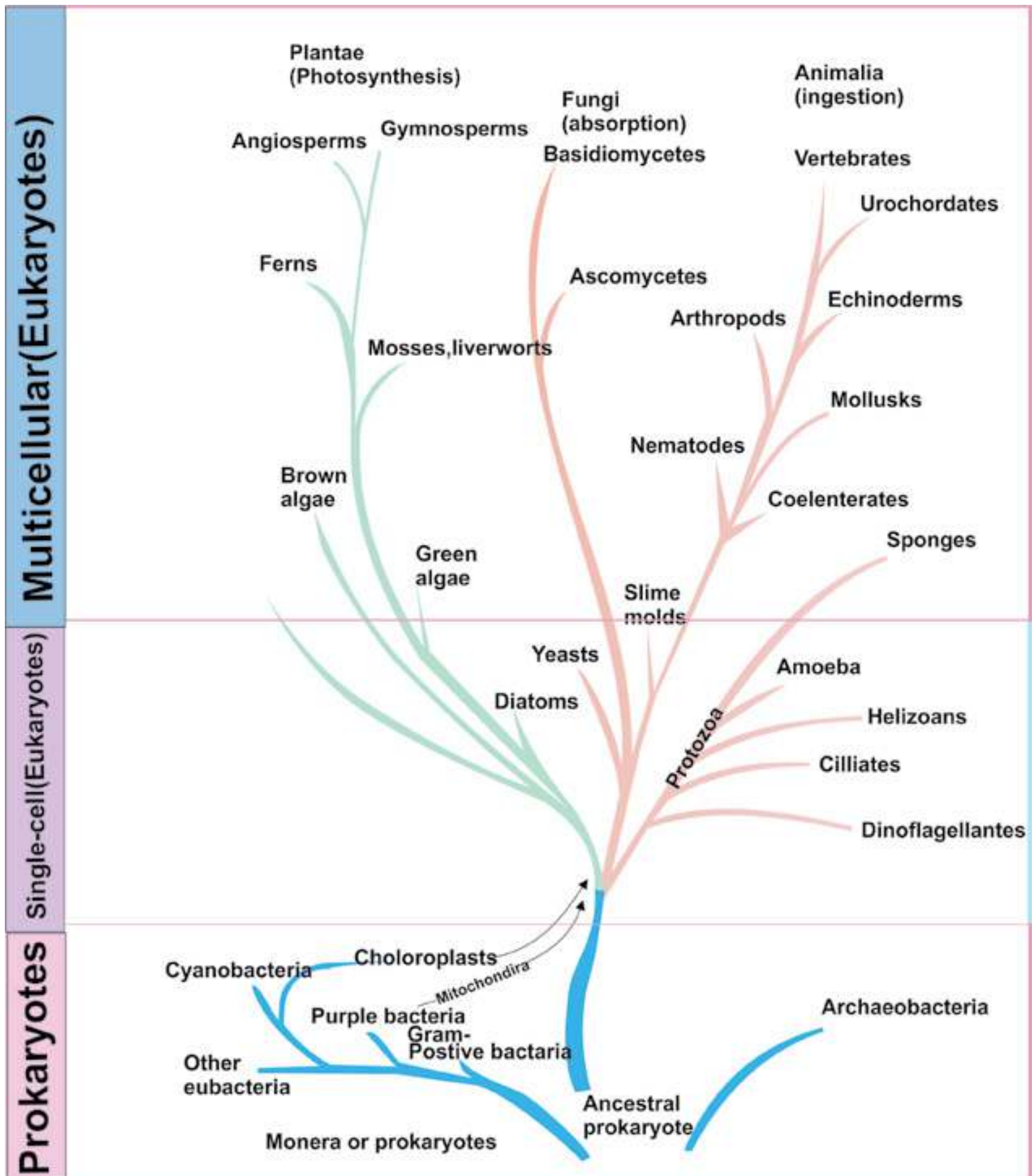

Fig. 5.2 Five kingdom classification by Whittaker

VIRUSES

About a century ago at the time of Louis Pasteur (1822-1895) and Robert Koch (1843-1910), the word “virus” was generally referred to as a poison associated with disease and death. The present notion of virus is entirely different. Now viruses are recognized as particles of nucleic acid often with a protein coat. They replicate in living cells and cause many diseases such as influenza, hepatitis, small pox and AIDS. In this section the focus is on the properties of viruses and life cycle of bacterial viruses, also known as bacteriophages. Some diseases caused by viruses shall also be discussed in this section. The branch which deals with the study of viruses is known as **virology**.

The word virus is derived from Latin word **venome** meaning poisonous fluid. It can be defined as non cellular infectious entities which contain either RNA or DNA, normally encased in proteinaceous coat, and reproduce only in living cells. Viruses utilize the biosynthetic machinery of the host for its own synthesis and then transfer themselves efficiently to other cells.

Some viral diseases have been known for centuries. In fact, the first infectious disease against which effective method of prevention was developed was a viral disease. In 1796, Edward Jenner first vaccinated an 8 years old boy with material removed from cowpox lesion on the hand of milkmaid. After six weeks the boy was inoculated with pus from a small pox victim, but he did not develop the disease. Later, Jenner used material for vaccination from cowpox lesions and successfully vaccinated 23 persons. As the material he used was obtained from cow (latin **vacca**), latter the term **vaccination** was used by Louis Pasteur for inoculation against disease.

In 1884, one of Pasteur’s associates, Charles Chamberland, found that bacteria can not pass through porcelain filters, while agent responsible for rabies (a disease which is transferred to human by bites of rabid dogs, foxes, cats, bats and other animals) can pass through these filters. As in those days the word virus was loosely used to describe any toxic substance that caused disease, those unseen filterable agents of disease were described as filterable viruses. In 1892, Ivanowski discovered that the agent which caused tobacco mosaic disease was filterable. He obtained bacteria free filtrate from ground up infected plants and placed it on healthy leaves of tobacco. He observed that filtrate produced the disease in healthy plants. After that, presence of similar filter-passing, ultramicroscopic agents was seen in the victims of many diseases, including foot and mouth disease (1898) and yellow fever (1901).

The filterable agents were first purified in 1935, when Stanley was successful in crystallizing the **tobacco mosaic virus**. Chemical analysis of these particles showed that they contained only nucleic acid and protein. This suggested that, unlike other forms, viruses are of simple chemical composition.

Bacteriophages, viruses that infect bacteria, were discovered independently by Twort in 1915 and D'Herelle in 1917. Twort observed that bacterial colonies sometimes undergo Lysis (dissolved and disappeared) and that this lysis can be transferred from one colony to other. Even highly diluted material from lysed colony can transfer the lytic effect. However, heating the filtrate destroyed its lytic property. From these observations he concluded that lytic agent might be a virus. D'Herelle rediscovered this phenomena in 1917 and used the word bacteriophages meaning "bacteria eater".

*Animation 5.1: Virus
Source and Credit: geocities*

Characteristics

Viruses are extremely small infectious agents, which can only be seen under an electron microscope. They range in size from 250 nanometer (nm) of poxviruses to the 20 nm of parvoviruses. They are 10 to 1000 times smaller than most bacteria, so they can pass through the pores of filter, from which bacteria cannot pass. Viruses cannot be grown on artificial media. They can reproduce only in animal and plant cells or in microorganisms, where they reproduce by replication (a process by which many copies or replicas of virus are formed). Thus the viruses are **obligate intracellular parasites**. Viruses lack metabolic machinery for the synthesis of their own nucleic acid and protein. They depend on the host cell to carry out these vital functions. During reproduction in the host cells, viruses may cause disease. All viruses are generally resistant to broad range of available antibiotics such as penicillin, streptomycin and others.

Structure

The complete, mature and infectious particle is known as **virion**. The virions are composed of a central core of **nucleic acid**, either DNA or RNA, which is also known as **the genome** and is surrounded by a protein coat, **the capsid**. Capsid gives definite shape to virion. Capsid is made up of protein subunits known as **capsomeres**. The number of capsomeres is characteristics of a particular virus. For example 162 capsomeres are present in the capsid of **herpes virus** and 252 in the capsid of **adenovirus** which cause some common colds. In some animal viruses the **nucleocapsid** (nucleic acid and capsid) is covered by another membrane derived from the host cell, **the envelope**. Non enveloped viruses are known as naked virions. Animal and plant viruses may be polyhedron (having many sides), helical (Spiral), enveloped or complex.

*The most recently discovered (1983) and least understood micro organisms are the **prions**, which may be infectious proteins. Their nature is very controversial. They are composed of protein only that contains the information that codes for their own replication. All other organisms contain their genetic information in nucleic acid (DNA or RNA). Prions are responsible for mad cow infection and mysterious brain infection in man.*

Bacterio-phages occur in two structural forms having cubical or helical symmetry. In general appearance cubical phages are regular solid or **icosahedral** (having 20 faces), and **helical** phages are rod shaped. Many phages consist of head and tail. In those cases heads are polyhedral but tails are rod shaped. Morphology of some viruses and bacteriophages has been shown in Fig 5.3.

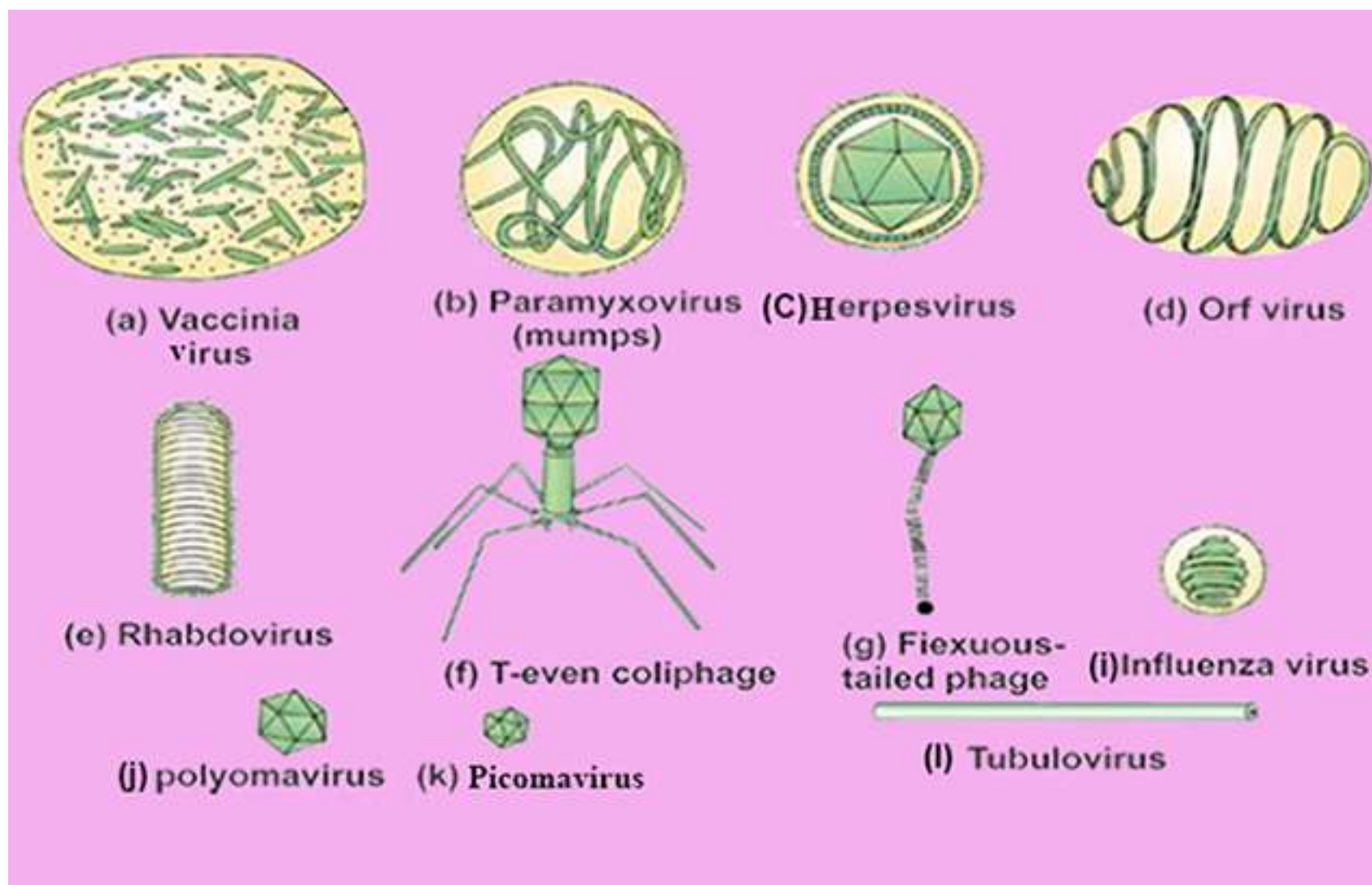

Fig. 5.3 Different types of viruses

Life Cycle of Bacteriophages

Earlier researches on bacteriophages were mainly on limited number of phages that infect *Escherichia coli*. Of these the best known phages are T phages (T for type).

Among T phages, the T_2 and T_4 phages are mainly used in phage studies. The overall structure of T_4 , studied with electron microscopy, resembles that of tadpole, consisting of head and tail (Fig 5.4). The head is an elongated pyramidal (having two triangular structures with common base), hexagonal, prism-shaped structure, to which straight tail is attached. Within the head double stranded DNA molecule is present. The structure of phage tail is more complex than head. A layer of distinct protein forms the inner tube or core, which is enclosed in **sheath** made up of another type of protein. On one side of sheath is **collar** and on other side is end plate. To end plate six **tail**

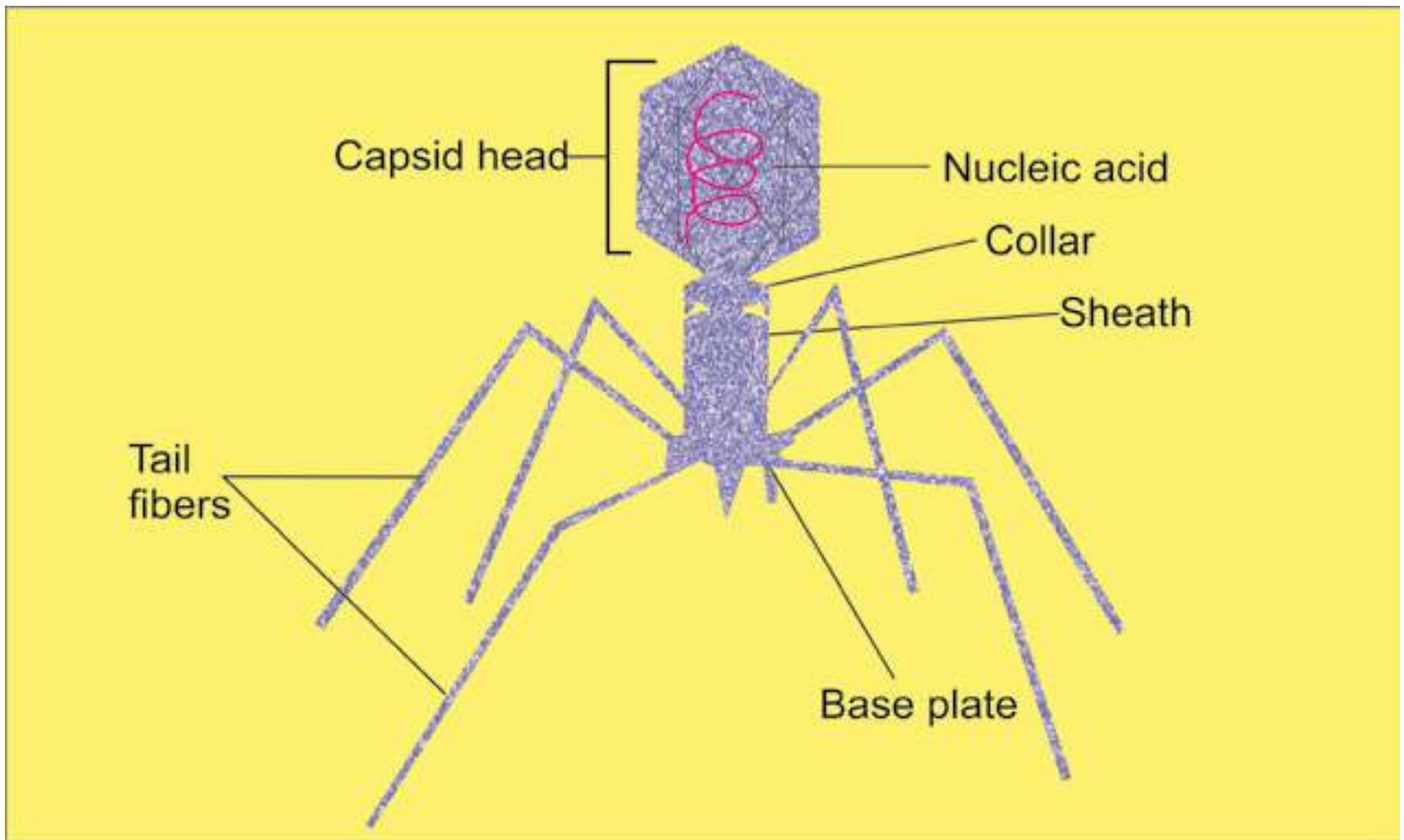

Fig. 5.4 A Bacteriophage

fibers are attached, which are the structures for attachment. The volume of the phage is about 1/1000 of the host.

The bacteriophage replicates only inside the bacterial cell. The first step in the replication of a bacteriophage is its **attachment (adsorption)** to host cell at receptor site on the cell wall of bacterium. During attachment, weak chemical union between virion and **receptor site** takes place. In the next step, **penetration**, the tail releases the enzyme **lysozyme** to dissolve a portion of the bacterial cell wall. The tail sheath contracts and tail core is forced into the cell through cell wall and cell membrane. The virus injects its DNA into the cell just as the syringe is used to inject the vaccine. The protein coat, which forms the phage head and tail structure of virus remains outside the cell (Fig 5.5). Many animal viruses, however enter the host cell as a whole.

Immediately after entering the host cell, the viral nucleic acid takes the control of the host's biosynthetic machinery and induces the host cell to synthesize necessary viral components (DNA, proteins), and starts **multiplying**. About 25 minutes after initial infection, approximately 200 new

bacteriophages are formed, bacterial cell bursts, i.e., it undergoes lysis. Newly formed phages are released to infect the bacteria and another cycle, **the lytic cycle** begins (Fig. 5.6). The phage which causes lysis of the host cell is known as **lytic or virulent phage**.

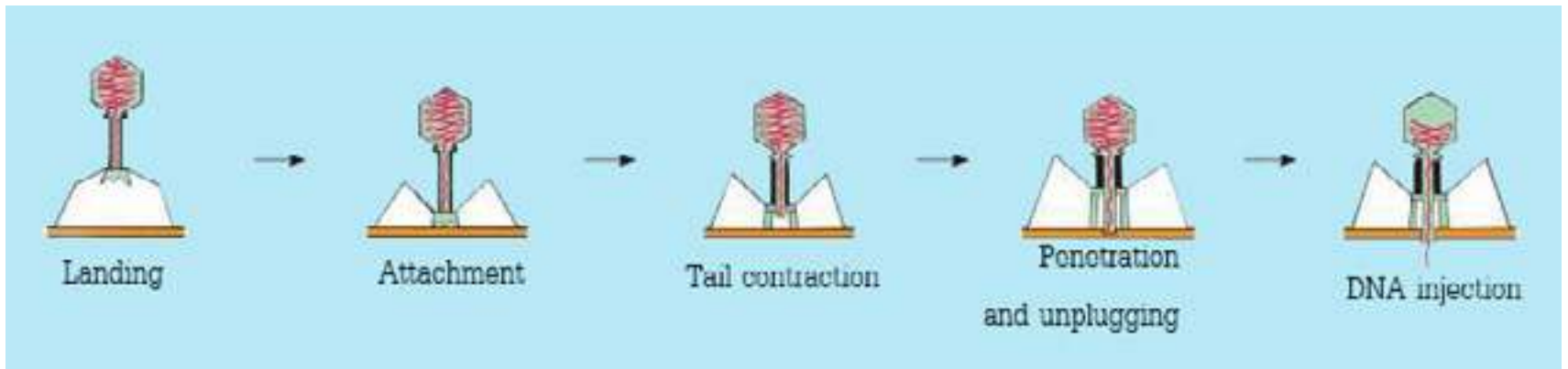
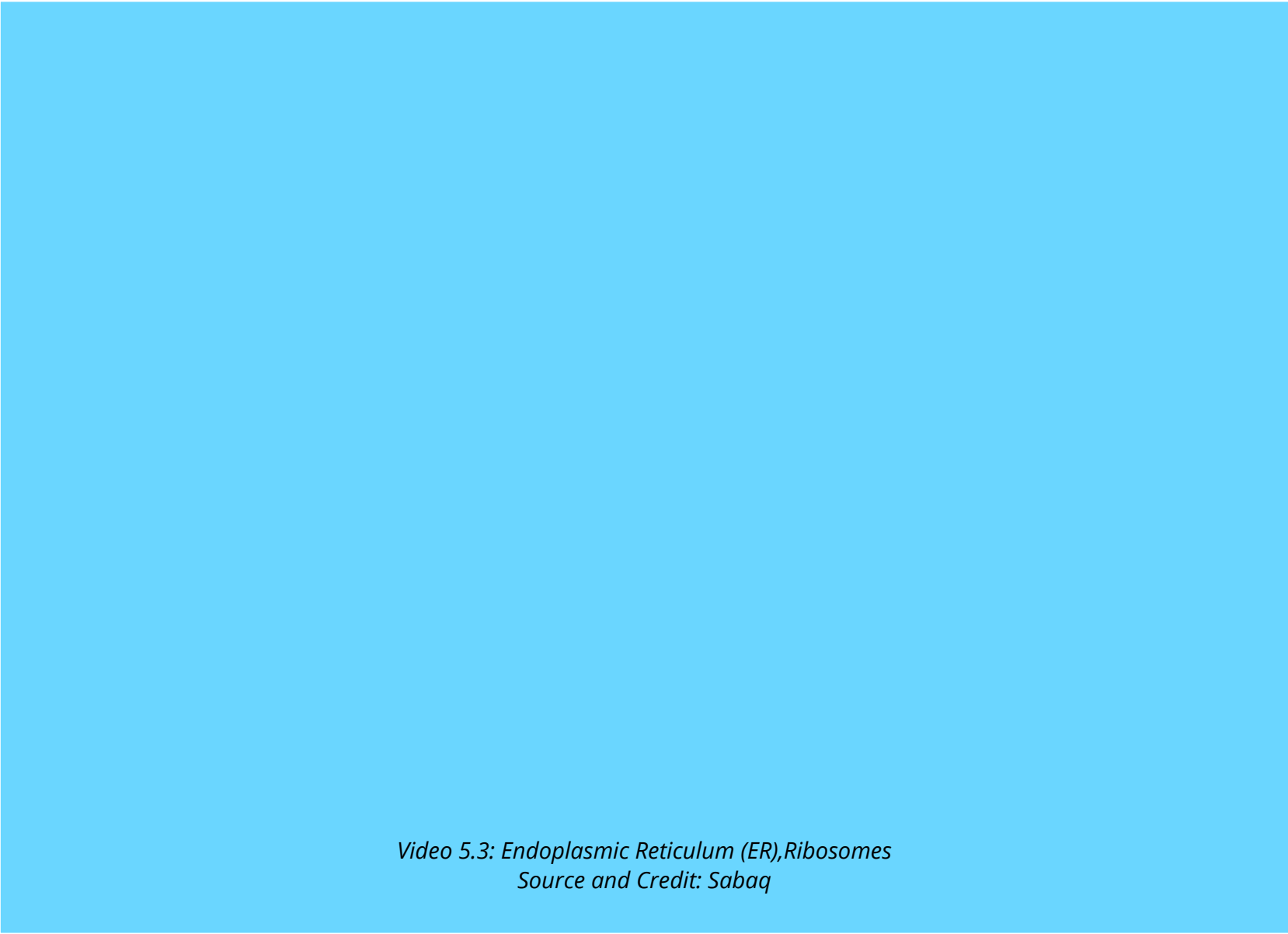
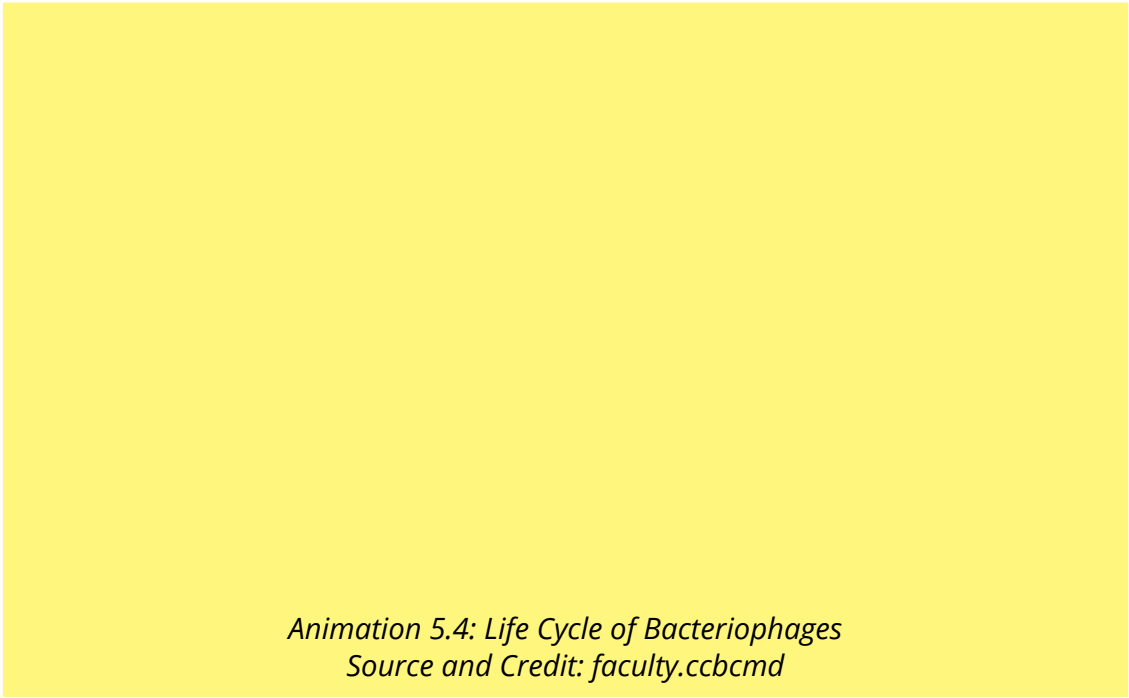

Fig 5.5 A phage injecting its DNA in to host





Video 5.3: Endoplasmic Reticulum (ER), Ribosomes
Source and Credit: Sabaq



Animation 5.4: Life Cycle of Bacteriophages
Source and Credit: faculty.ccbcmd

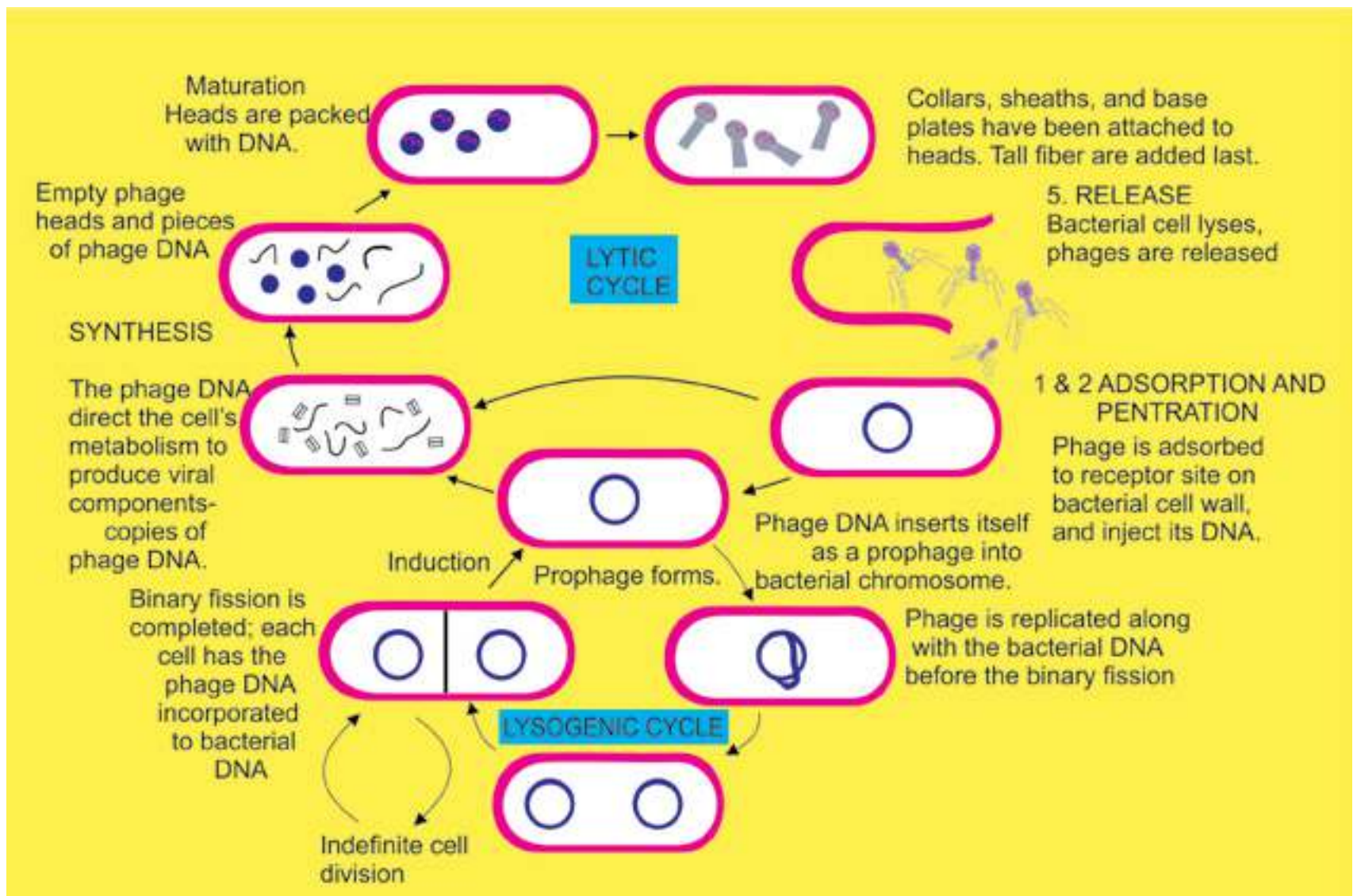

Fig. 5.6 Replication of a bacteriophage. After adsorption and penetration, the virus DNA undergoes prophage formation (1) In the lysogenic cycle, phages can exist harmlessly as a prophage within the host cell for long periods of time. Each time the bacterial chromosome is replicated, the prophage also is replicated, and hence all daughter bacterial cells are "infected" with the prophage. Induction involves either a spontaneous or environmentally induced excision of the prophage from the bacterial chromosome. (2) A typical lytic cycle, involves synthesis and maturation of phage and new phages are released.

All infections of bacterial cells by phages do not result in lysis. In some cases viral DNA, instead of taking over the control of host's machinery, becomes incorporated into the bacterial chromosome. Phage in this state is called **prophage** and this process is known as **lysogeny**. In this condition the bacterium continues to live and reproduce normally. Viral DNA being the part of bacterial chromosome passes to each daughter cell in all successive generations. Some times, however, the viral DNA gets detached from the host's chromosome and lytic cycle starts. This process is called **induction**. Lysogenic bacteria are resistant to infection by the same or related phages. The phage which causes lysogeny is called **temperate (lysogenic) phage**.

Classification of Viruses

Virus morphology and nucleic acid properties are most important for classifying plant, animal and bacterial viruses. The genetic material may be DNA or RNA naked, enveloped or complex. On the basis of morphology viruses are classified into rod shaped (T.M.V), spherical (poliovirus) and tadpole like bacteriophage viruses etc. Fig. 3.5 and 5.4.

Some Viral Diseases

There are many diseases which are caused by viruses. Only those are being mentioned here which have been or are common in Pakistan.

Small pox: Smallpox, which is caused by pox viruses (the DNA enveloped virus) is an ancient disease that is known to have occurred as epidemic in China as early as the twelfth century B.C. Until the early twentieth century, small pox was a common disease throughout the world. In small pox, raised fluid-filled vesicles are formed on the body which become pustules later on and form pitted scars, **the pocks**. By 1950's immunization and other control measures had largely decreased the danger, but it is still present in the third world countries where many people are affected. In 1980, it was declared by World Health Organization that small pox has been eradicated from the world.

Herpes simplex: Herpes virus (DNA virus) is responsible for this disease. It is naturally occurring disease of mankind. In this vascular lesions in the epithelial layers of ectodermal tissues are formed. Most commonly this disease occurs in the mouth, on the lips, and at other skin sites.

Influenza: Influenza viruses are enveloped RNA viruses. Influenza is wide spread disease in man and occurs in epidemic form.

Mumps and Measles: Mumps and Measles viruses belong to group **paramyxoviruses**. They are large, enveloped, RNA viruses. Mumps is highly contagious, wide spread, but seldom fatal. About 60% of adults are immune to it. Measles is one of the commonest diseases of the childhood and adult human population is equally susceptible the world over. This disease develops immunity in its victim.

Polio: Poliomyelitis, caused by polio virus, is found all over the world. It occurs mostly in childhood.

The age at which primary infection occurs varies with social and economic factors. The polioviruses are the smallest known viruses and contain RNA in spherical capsid. Some common human viral diseases are shown in Fig 5.7.

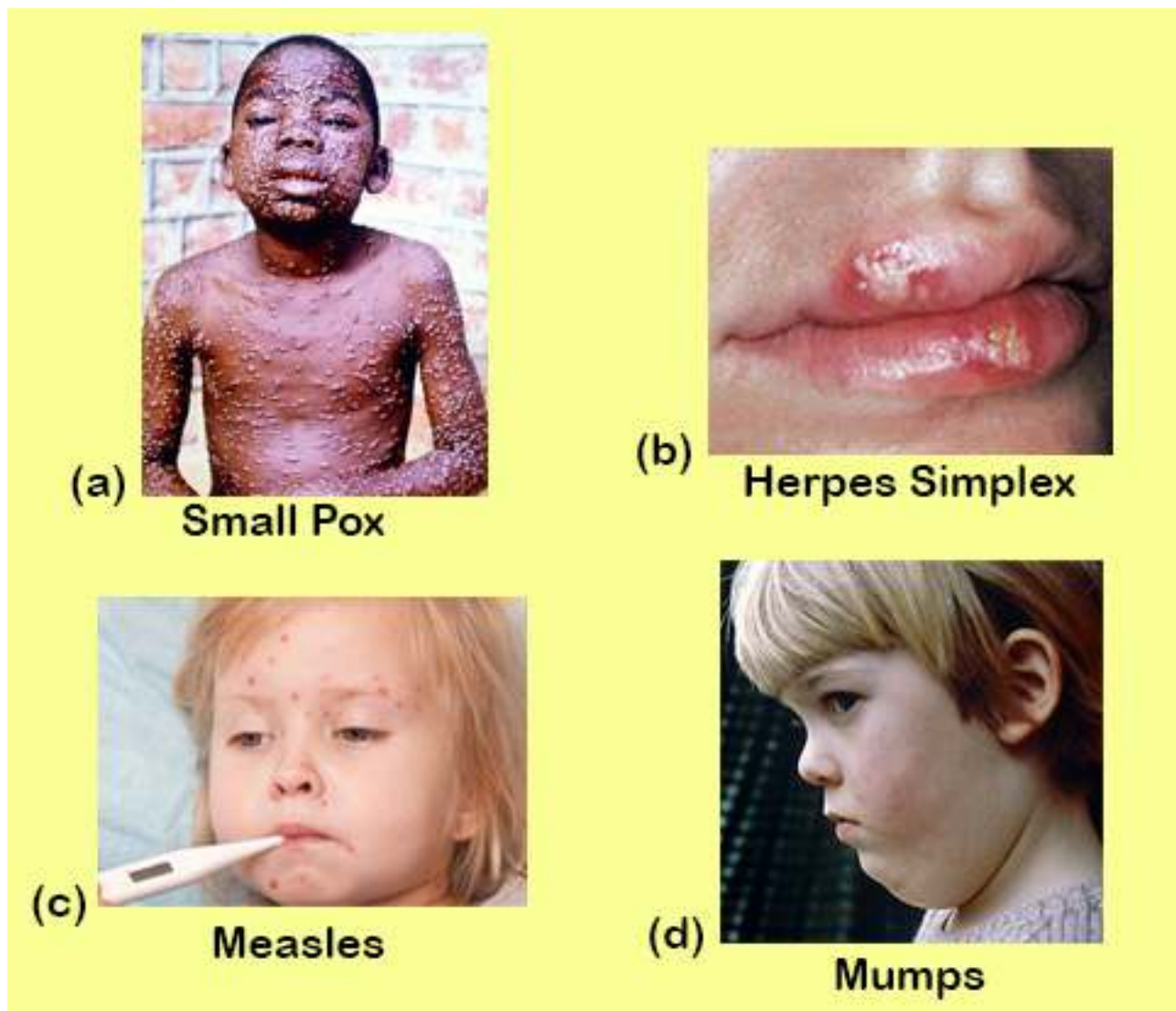

Fig. 5.7 Some common human viral diseases

Retroviruses

RNA tumor viruses have been known for many years. These viruses are widely distributed in nature and are associated with tumor production in a number of animal species, such as fowl, rodents and cats. The most familiar of viruses is the **human immunodeficiency virus (HIV)** which causes **acquired immune deficiency syndrome (AIDS)**.

The single stranded RNA tumor viruses, which also include **retroviruses (oncoviruses)**, are spherical in form, about 100nm in diameter and enveloped by host plasma membrane. Although a few retroviruses are non specific that is they can infect any cell, most of them can infect only host

cells that possess required receptors. In the case of AIDS virus, the host cell possesses a receptor that allows the viral adsorption and penetration in several types of **leukocytes** (white blood cells) and tissue cells. The retroviruses have a special enzyme called **reverse transcriptase**, which can convert a single -stranded RNA genome into double stranded viral DNA. Not only this DNA can infect host cells, but it also can be incorporated into host genome as a **provirus** that can be passed on to progeny cells. In this way, some of retroviruses can convert normal cells into cancer cells.

Acquired Immune Deficiency Syndrome (AIDS)

The AIDS was reported by some physicians in early 1980's in young males having one or more of complex symptoms such as severe pneumonia, a rare vascular cancer, sudden weight loss, swollen lymph nodes and general loss of immune functions. All these young patients were homosexuals. Soon after the disease was discovered in nonhomosexual patients who were given blood (blood transfusion) or blood products. In 1984 the agent causing the disease was identified by research teams from Pasteur Institute in France and National Institute of health in USA. In 1986 the virus was named as **human immunodeficiency virus (HIV)** (Fig 5.8). The major cell infected by HIV is the helper **T-lymphocyte**, which is major component of immune system. As the HIV infection continues in the host, the decrease of helper T-lymphocytes results in failure of the immune system and the infected person becomes susceptible to other diseases. Cells in central nervous system can also be infected by HIV Fig. 5.9. Recent studies on HIV reveal that the virus infects and multiplies in monkey but does not cause disease in them, which means that HIV is **host specific**.

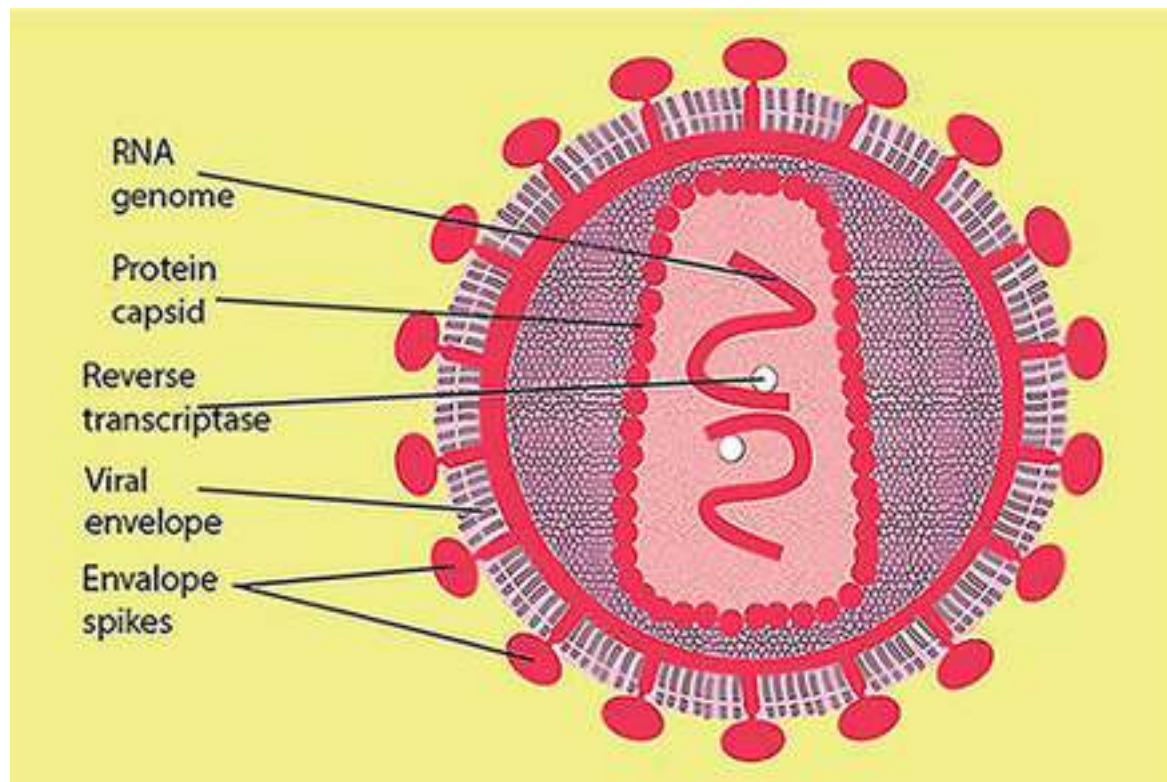

Fig. 5.8 Human immunodeficiency virus (HIV)

The HIV is transmitted by intimate sexual contact, contact with blood and breast feeding. Healthcare workers can also acquire HIV during professional activities. Avoiding the direct contact with HIV is important measure for preventing the disease. Prevention of intravenous drugs with common syringes and use of sterile needles/syringes and utensils is important. Now vaccine against HIV has been synthesized and its experimental administration in humans started in early 2001 in South Africa.

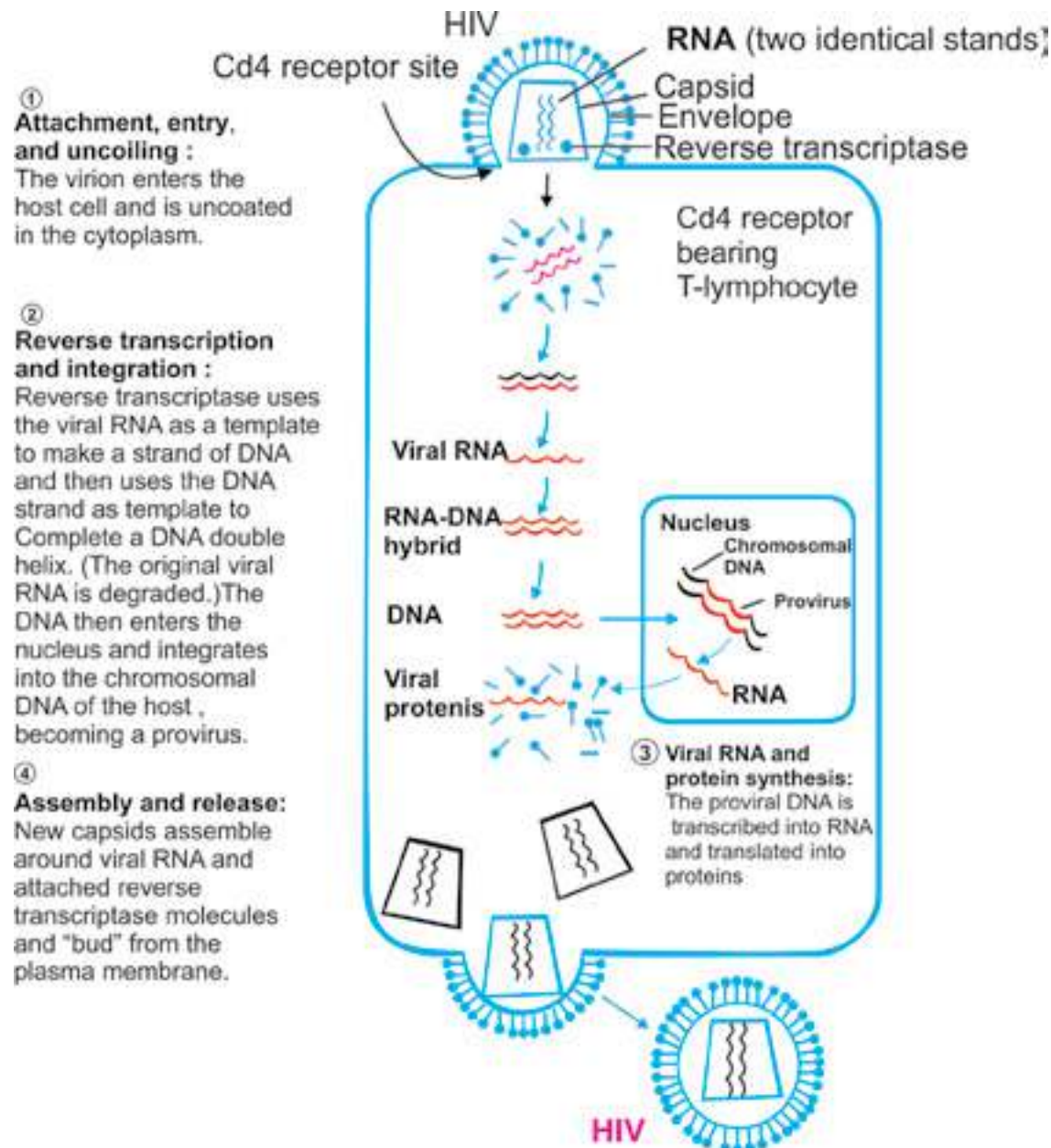

Fig 5.9 Infection cycle of HIV

Hepatitis

Hepatitis is an inflammation of the liver. It is usually caused by viral infection, toxic agents or drugs. It is characterized by jaundice, abdominal pain, liver enlargement, fatigue and some times fever. It may be mild or can be acute and can lead to liver cancer. The different types of viral hepatitis are **Hepatitis A** (formerly called infectious hepatitis is transmitted by contact with faeces from infected

individuals.) **Hepatitis B** (serum hepatitis). **Hepatitis C** (formerly called non-A, non-B hepatitis) passes through blood, from mother to child during pregnancy and afterward and by sexual contact. **Hepatitis D** (delta hepatitis), **Hepatitis E** (a virus transmitted through the faeces of an infected person), **Hepatitis F, G** (caused by viruses yet unidentified). Viruses of hepatitis A, B and C are better known. Hepatitis A virus (**HAV**) is an RNA virus (non enveloped), which causes mild short term, less virulent disease. Hepatitis C virus (**HCV**) is also RNA virus (enveloped) causes infusion hepatitis, which is less severe than hepatitis A or hepatitis B, but hepatitis C often leads to chronic liver disease. Most recent work of Halbur and coworker (2001) reveals that pig could be the source of infection of hepatitis E.

Hepatitis B (**HBV**) is the second major form of hepatitis. It is caused by DNA virus which is very common in Asia, China, Philippines, Africa and the Middle East. Hepatitis B is transmitted by the exchange of body fluids, for example blood serum, breast milk and saliva, from mother to child during birth or afterward and by sexual contact.. During acute attacks of Hepatitis B fatigue, loss of appetite and jaundice are reported. Infected persons can recover completely and become immune to the virus. People with chronic hepatitis infection are at the risk of liver damage. Hepatitis can be controlled by adopting hygienic measures, with routine vaccination and screening of blood/ organ/ tissue of the donor.

Genetically engineered vaccine is available for HBV.
Vaccine is also available for HAV but not for HCV.

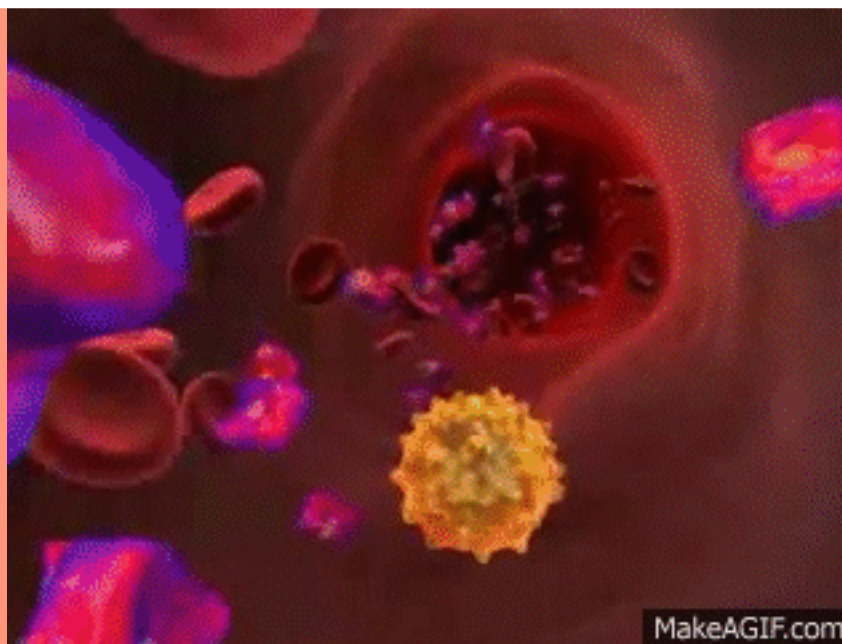

*Animation 5.5: HIV
Source and Credit: makeagif*

EXERCISE

Q.1. Fill in the blanks

- (i) C. Linnaeus divided all known forms of life into two kingdoms: _____ and _____. Bacteria were placed in the kingdom _____ because they have cell walls, and protozoa were placed in the kingdom _____ because they move from place to place and ingest food.
- (ii) The most common system of classification used today, developed in 1969 by Robert Whittaker of Cornell University, uses five kingdoms: _____ and _____.
- (iii) Whittaker's five kingdom system of classification recognizes two basic types of cells: _____ and _____.
- (iv) In five kingdom system of classification proposed by Margulis and Schwartz organelles of symbiotic origin such as _____ and _____ were also considered.
- (v) A bacteriophage reproduces by using the metabolic machinery of _____.
- (vi) The protein coat that encloses the viral genome is called: _____ It is made up of _____.
- (vii) Retroviruses are _____ viruses which have specific enzymes _____ by which they convert RNA to DNA.
- (viii) HIV infects _____ and the defects in these cells lead to failure in _____ system.
- (ix) Hepatitis is caused by _____.
- (x) Viral Hepatitis is of _____ types. Hepatitis A and C are caused by _____ virus whereas _____ virus is the causative agent of Hepatitis B.

CHAPTER



Kingdom Prokaryotae (Monera)

Animation 6.1: Enzyme
Source & Credit: Wikispaces

Kingdom Prokaryotae consists of organisms with prokaryotic cells. In Greek the word *Pro* means “before” and *karyon* means nucleus. Microbiologists place bacteria in two major categories: eubacteria (Greek for “true bacteria”) and a much smaller division, the archaeobacteria (Greek for “ancient bacteria”).

DISCOVERY OF BACTERIA

It had long been suspected that small creatures exist which are too small to be seen with naked eye. But their discovery was linked to the invention of microscope. A Dutch Scientist “AntonieVan Leeuwenhoek” (1673) was the first to report the microbes such as bacteria and protozoa. He used a simple microscope to describe bacteria and protozoa with accurate drawings and descriptions and called these small creatures as “**animalcules**”. He firstly observed small creatures in rain water, then confirmed these in saliva, vinegar, infusions and other substances.

The progress in understanding the nature and importance of these tiny organisms has been slow. The existence of microbes was further confirmed by Louis Pasteur’s work. Pasteur went on making many discoveries in the field of microbiology and medicine. His main achievements are the development of vaccines for disease **anthrax, fowl cholera** and **rabies**. He also made significant contributions in development of pasteurization process and development of fermentation industries. He proved that microorganisms could cause disease.

Robert Koch formulated the ‘**germ theory of disease**’. He isolated typical rodshaped bacteria with squarish ends (baccilli) from the blood of sheep that had died of anthrax. Then he discovered bacteria that caused **tuberculosis** and cholera. He formulated four **postulates**, which are the main pillars of the germ theory of disease. These are used to find out whether the organism found in disease lesions is the causal agent of the disease or not.

1. A specific organism can always be found in association with a given disease.
2. The organism can be isolated and grown in pure culture in the laboratory.
3. The pure culture will produce the disease when inoculated into susceptible animal.
4. It is possible to recover the organism in pure culture from experimentally infected animal.

Koch and his colleagues invented many techniques concerning inoculation, isolation, media preparation, maintenance of pure cultures and preparation of specimens for microscopic examinations.

OCCURRENCE OF BACTERIA

Bacteria are wide spread in their occurrence. They are found almost everywhere, in air, land, water, oil deposits, food, decaying organic matter, plants, man and animals. Their kind and number vary according to locality and environmental conditions. Some bacteria are always present and contribute towards the natural flora. Others are present in specific environments such as hot springs, alkaline/acidic soil, highly saline environments, in highly polluted soils and waters.

Animation 6.2: Bacteria Animated
Source and Credit: pinterest

STRUCTURE OF BACTERIA

All bacterial cells invariably have a cell membrane, cytoplasm, ribosome, and chromatin bodies. The majority have a cell wall, which gives shape to the bacterial cell. Specific structures like capsule, slime, flagella, pili, fimbriae and granules are not found in all bacteria (refer to Fig. 4.17).

Size

Bacteria range in size from about 0.1 to 600 μm over a single dimension. Bacteria vary in size as much as in shape. The smallest (e.g., some members of the genus *Mycoplasma*) are about 100 to 200 μm in diameter, approximately the size of the largest viruses (poxviruses) *Escherichia coli*, a bacillus of about average size, is 1.1 to 1.5 μm wide by 2.0 to 6.0 μm long. Some spirochetes occasionally reach 500 μm in length whereas Staphylococci and Streptococci are 0.75 - 1.25 μ in diameter.

Recently a huge bacterium has been discovered in the intestine of the brown surgeonfish, *Acanthurus nigrofuscus*. *Epulopiscium fishelsoni* grows as large as 600 μm by 80 μm , a little smaller than a printed hyphen. It is now clear that a few bacteria are much larger than the average eukaryotic cell.

Shape of Bacteria

On the basis of general shape, bacteria are classified into three categories. These shapes are known as cocci, bacilli and spiral. Although most of the bacterial species have fairly constant characteristic cell shape, yet some cells are pleomorphic and they can exist in a variety of shapes.

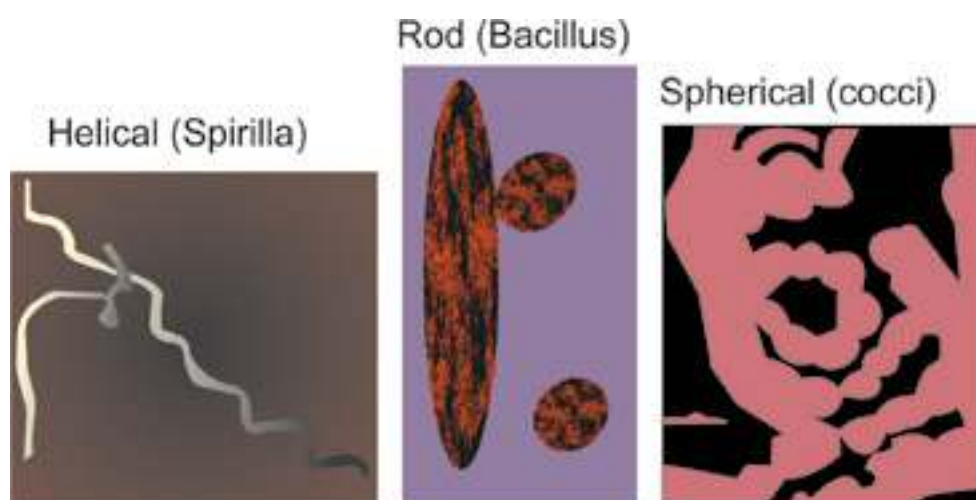

Fig 6.1 Shapes of Bacteria

Exceptions to the above shapes are trichome forming, sheathed, stalked, square, starshaped, spindle-shaped, lobed and filamentous bacteria.

The **cocci** are spherical or oval bacteria having one of several distinct arrangements based on their planes of division. If division is in one plane it will produce either a **diplococcus** or **streptococcus** arrangement. When cocci occur in pairs then arrangement is diplococcus, whereas when cocci form long chain of cells then arrangement is called as streptococci. When the division of cell is in two planes it will produce a **tetrad** arrangement. A tetrad is a square of 4 cocci. Thirdly, when the division is in three planes, it will produce a **sarcina** arrangement. Sarcina is a cube of 8 cocci. When division occurs in random planes, it will produce a **staphylococcus** arrangement in which cocci are arranged in irregular, often grape-like clusters. *Diplococcus pneumoniae* and *Staphylococcus aureus* are some examples of cocci.



Fig. 6.2 Cocci

Animation 6.3: Bacteria shape
Source and Credit: gif2fly

Bacilli are rod-shaped bacteria. Bacilli all divide in one plane producing a **bacillus**, **streptobacillus**, or **diplobacillus**. Bacillus is a single cell of bacteria. Streptobacillus is a chain of bacilli. When rod shaped bacteria occur in pairs then arrangement of cells is known as diplobacilli. Examples of rod shaped bacteria are *Escherichia coli*, *Bacillus subtilis*, *Pseudomonas*.

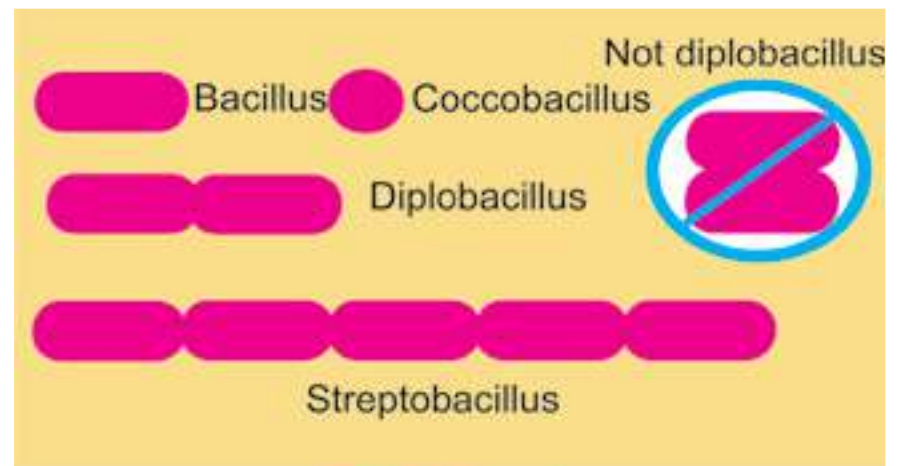
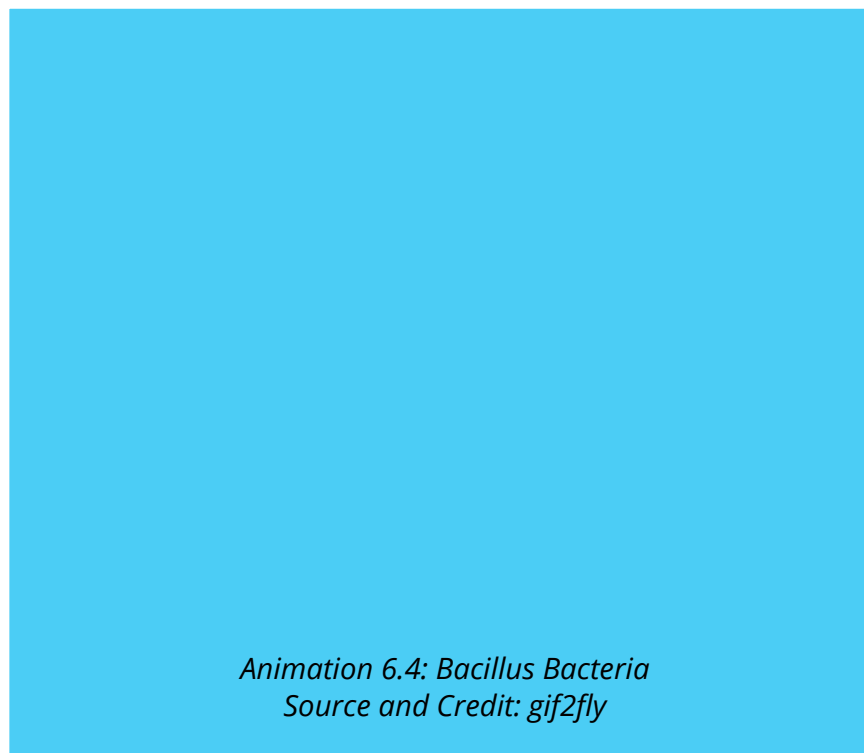

Fig. 6.3 Bacilli



Animation 6.4: Bacillus Bacteria
Source and Credit: gif2fly

The spiral shaped bacteria are spirally coiled. Spirals come in one of three forms, a **vibrio**, a **spirillum**, or a **spirochete**. Vibrio is curved or comma-shaped rod. Spirillum is a thick, rigid spiral. Spirochete is a thin, flexible spiral. Examples of spiral shaped bacteria are *Vibrio*, *Hyphomicrobium*.

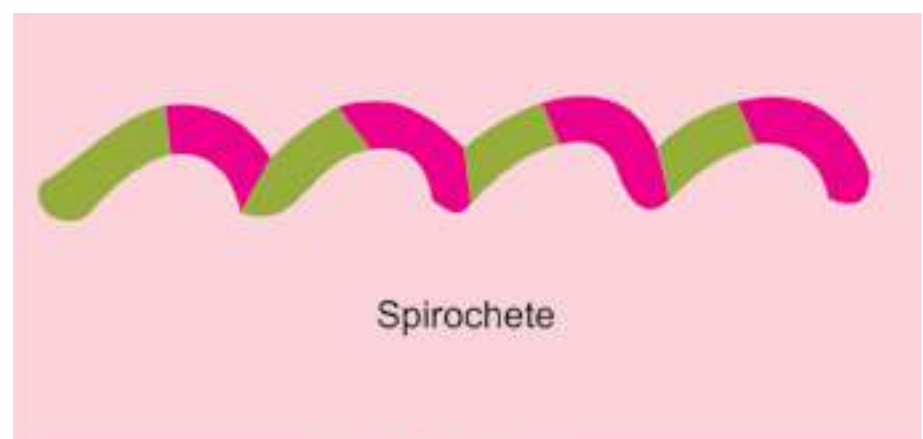

Fig. 6.4 Spirilla



Bacterial Cell Structure

Flagella and their frictions : These are extremely thin, hair like appendages. They come out through cell wall and originate from basal body, structure just beneath the cell membrane in the cytoplasm. They are made up of protein **flagellin**. On the basis of presence of flagella, pattern of attachment of flagella and the number of flagella present bacteria are classified into different taxonomic groups. **Atrichous** means bacteria are without any flagella. When single polar flagellum is present then condition is known as **monotrichous**. If tuft of flagella is present only at one pole of bacteria then these are lophotrichous flagella. **Amphitrichous** is a condition when tuft of flagella at each of two poles is present. In **peritrichous** form, flagella surround the whole cell. Most of bacilli and spiral shaped bacteria have flagella. Cocci very rarely have flagella.

Primary function of flagella is to help in motility. With the help of flagella, flagellate bacteria can also detect and move in response to chemical signals which is a type of behaviour called as *Chemotaxis*.

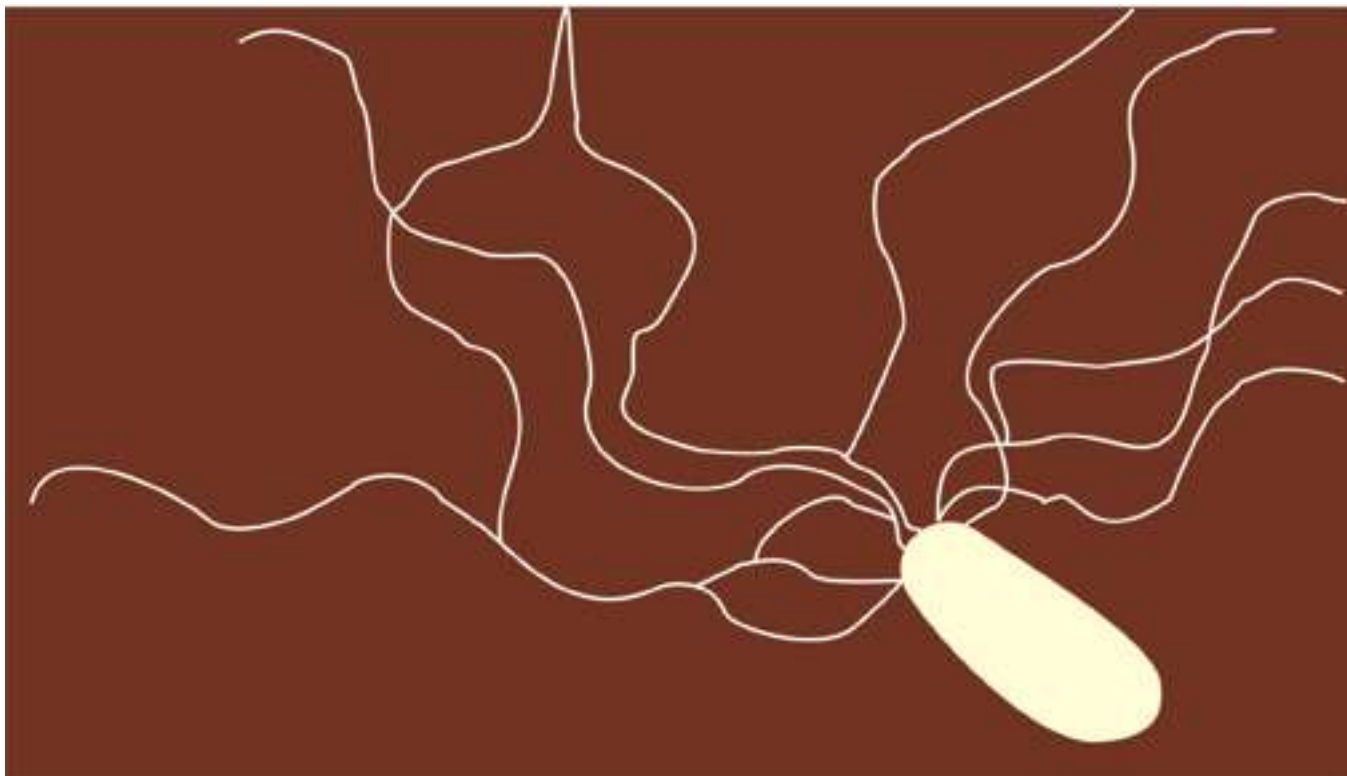

Fig. 6.5 Rod shaped bacterium with flagella (lophotricous)

Pili and their Functions

These are hollow, nonhelical, filamentous appendages. **Pili** are smaller than flagella and are not involved in motility. True pili are only present on gram-negative bacteria. They are made up of special protein called **pilin**. They are primarily involved in a mating process between cells called **conjugation** process. Some pili function as a **means** of attachment of bacteria to various surfaces.

The cell envelope: The outer wrapping of bacteria

Bacterial surface and walls are very diverse. Collectively complexes of layer external to the cell protoplasm are called as cell envelope and include capsule, slime and cell wall.

Capsule : Bacteria produce capsule, which is made up of repeating polysaccharide units, and of protein, or of both, capsule is tightly bound to the cell. It has a thicker, gummy nature that gives sticky characters to colonies of encapsulated bacteria. It provides pathogenicity.

Slime : Some bacteria are covered with loose, soluble shield of macromolecules which is called as slime capsule and slime provides greater pathogenicity to bacteria and protects them against phagocytosis.

Cell Wall: Beneath the extracellular substances and external to cytoplasmic membrane cell wall is present. It is a rigid structure. It determines the shape of bacterium. Cell wall also protect the cells from osmotic lysis. Cell wall is only absent in mycoplasmas. Christain Gram developed the technique of gram stain. Bacteria could be divided into two groups based on their response to gram staining procedure. By this Staining technique **Gram-positive bacteria** are stained purple (retain the primary dye due to formation of CV-I complex) and **Gram-negative bacteria** are stained pink (retain secondary dye) in colour. There are many structural differences between two groups (Table 6.1) which are the primary basis for difference in staining behaviour.

Table 6.1: Comparison of Gram-positive and Gram-negative cell walls.

Characteristics	Gram-Positive	Gram-negative
Number of major layers	1	2
Chemical make up	Peptidoglycan (50% of dry weight in some bacterial cells) Teichoic acid Lipoteichoic acid	Lipopolysaccharides Lipoproteins Peptidoglycan 10% dry weight of some bacterial cells
Overall thickness	Lipids (1-4%) 20-80 nm	Lipids (11-12%) 8-11 nm
Outer membrane	No	Yes
Periplasmic space	Present in some	Present in all
Permeability	More permeable	Less permeable

The cell walls of most bacteria have a unique macromolecule called as **peptidoglycan**. Its amount varies in different types of bacteria. It is composed of framework of long glycan chains cross-linked with peptide fragments. The intact cell wall also contains chemical constituents such as sugar molecules, teichoic acid, lipoproteins and lipopolysaccharides, which are linked to peptidoglycan.

Several bacterial groups lack the cell wall structure characteristic of Gram positive or Gram negative bacteria, and some bacteria have no cell wall at all. Cell walls of archaebacteria are different from eubacteria. They do not contain peptidoglycan. Their cell walls are composed of proteins, glycoproteins and polysaccharides).

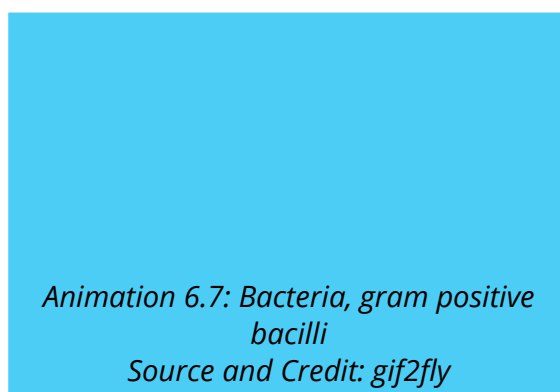

Cell Membrane

Just beneath the cell wall is the cell membrane or plasma membrane. It is very thin, flexible and completely surrounds the cytoplasm. Plasma membrane is very delicate in nature any damage to it results in death of the organism. Bacterial membranes differ from eukaryotic membranes in lacking sterols such as cholesterol.

Cell membrane regulates the transport of proteins, nutrients, sugar and electrons or other metabolites. The plasma membranes of bacteria also contain enzymes for respiratory metabolism.

Cytoplasmic matrix

The cytoplasm of prokaryotic cell lacks membrane bound organelles and cytoskeleton (microtubules). The cytoplasmic matrix is the substance present between the plasma membrane and the nucleoid. It has gel like consistency. Small molecules can move through it rapidly. The plasma membrane and every thing present within it is known as protoplast. Thus the cytoplasmic matrix is a major part of protoplast. Other large discrete structures such as chromatin /nuclear body, ribosomes, mesosomes and granules and nucleoid are present in this matrix.

Nucleoid

A bacterial cell unlike the cells of eukaryotic organisms lacks discrete chromosomes and nuclear membrane. The nuclear material or DNA in bacterial cells occupies a position near to the center of cell. This material is a single, circular and double stranded DNA molecule. It aggregates as an irregular shaped dense area called the **nucleoid**. This **chromatin body** is actually an extremely long molecule of DNA that is tightly folded so as to fit inside the cell component. Since bacteria have a single chromosome, they are haploid.

Other names for nucleoid are nuclear body, chromatin body and nuclear region.

It is visible in the light microscope after staining with Feulgen stain.

Escherichia coli closed circle chromosome measures approximately 1,4000 μ m

Plasmid

Many bacteria contain plasmids in addition to chromosomes. These are the circular, double stranded DNA molecules. They are self-replicating and are not essential for bacterial growth and metabolism. They often contain drug resistant, heavy metals, disease and insect resistant genes on them.

Plasmids are important vectors, in modern genetic engineering techniques.

Ribosomes

Ribosomes are composed of RNA and proteins. Some may also be loosely attached to plasma membranes. They are protein factories. There are thousands of ribosomes in each healthy growing cell. They are smaller than eukaryotic ribosomes.

Mesosomes

The cell membrane, invaginates into the cytoplasm forming structure called as **mesosome**. Mesosomes are in the form of vesicles, tubules or lamellae. Mesosomes are involved in DNA replication and cell division whereas some mesosomes are also involved in export of extracellular enzyme. Respiratory enzymes are also present on the mesosomes.

Granules and storage bodies

Since bacteria exist in a very competitive environment where nutrients are usually in short supply. They tend to store extra nutrients when possible. These may be glycogen, sulphur, fat and phosphate. In addition, cells contain waste materials that are subsequently excreted. For example, common waste materials are alcohol, lactic acid and acetic acid.

Spores

Certain species of bacteria produce spores, either external to the vegetative cells (exospores) or

within the vegetative cells (endospores). They are metabolically dormant bodies and are produced at a late-stage of cell growth. Spores are resistant to adverse physical environmental conditions such as light, high temperature, desiccation, pH and chemical agents, Under favorable conditions they germinate and form vegetative cells.

Cysts

Cysts are dormant, thick-walled, desiccation resistant forms and develop during differentiation of vegetative cells which can germinate under suitable condition. They are not heat resistant.

Nutritio. of Bacteria

Like other organisms bacteria need energy for their growth, maintenance and reproduction. Most bacteria are **heterotrophic** i.e.. they cannot synthesize their organic compounds from simple inorganic substances. They live either as saprophytes or as parasites. **Saprophytic bacteria** get their food from dead organic matter. Soil is full of organic compounds in the form of humus. Humus is the material resulting from the partial decay of plants and animals. Many soil inhabiting bacteria have very extensive enzyme system that breaks down the complex substances of humus to simpler compounds. The bacteria can then absorb and utilize these simpler substances as a source of energy. **Parasitic bacteria** for their nutrition are fully dependent on their host.

Some kinds of bacteria are **autotrophic** i.e., they can synthesize organic compounds which are necessary for their survival from inorganic substances. These bacteria may be separated into two groups: **photosynthetic autotrophs** and **chemosynthetic autotrophs**. **Photosynthetic bacteria** possess chlorophyll which differs from the chlorophyll of green plants. Unlike most green plants, which have their chlorophyll in chloroplasts, bacterial chlorophyll is dispersed in the cytoplasm. During photosynthesis the autotrophic bacteria utilize hydrogen sulphide (H₂S) instead of water as a hydrogen source and liberate sulphur instead of oxygen. Nitrifying bacteria are chemosynthetic. **Chemosynthetic bacteria** oxidize inorganic compounds like ammonia, nitrate, nitrite, sulphur or ferrous iron and trap the energy thus released for their synthetic reactions. The overall reaction of photosynthesis in photosynthetic bacteria can be written as :

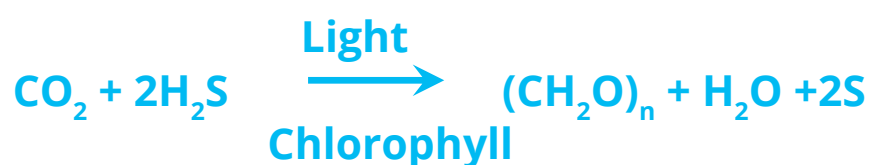

Green sulphur bacteria, purple sulphur bacteria and purple non-sulphur bacteria are photosynthetic bacteria.

Respiratio. i. Bacteria

Respiration in bacteria may be aerobic (requiring free oxygen) or anaerobic not requiring free oxygen. Bacteria, which are able to grow in the presence of oxygen, are called aerobic bacteria. While those which can grow in the absence of oxygen are known as **anaerobic bacteria**. Some bacteria are neither aerobic nor anaerobic, but facultative. **Facultative bacteria** grow either in the presence or absence of oxygen. Some bacteria require a low concentration of oxygen for growth and are known as **microaerophilic**.

Pseudomonas is an aerobic bacterium.

Spirochete is an anaerobic bacterium.

E.coli is a facultative anaerobic bacterium.

Campylobacter is a microaerophilic bacterium.

Growth and Reproduction.

Bacterial growth refers commonly to increase in number of bacterial cells. Bacteria increase in number by an asexual means of reproduction, called binary fission. In binary fission parent cell enlarges, its chromosome duplicates, and plasma membrane pinches inward at the center of the cell. When nuclear material has been evenly distributed, the cell wall grows inward to separate cell into two. This sequence is repeated at intervals by each new daughter cell which in turn increases the population of cells. Once the division is complete, bacteria grow and develop their unique features. The interval of time until the completion of next division is known as generation time. Four distinct phases are recognized in bacterial growth curve.

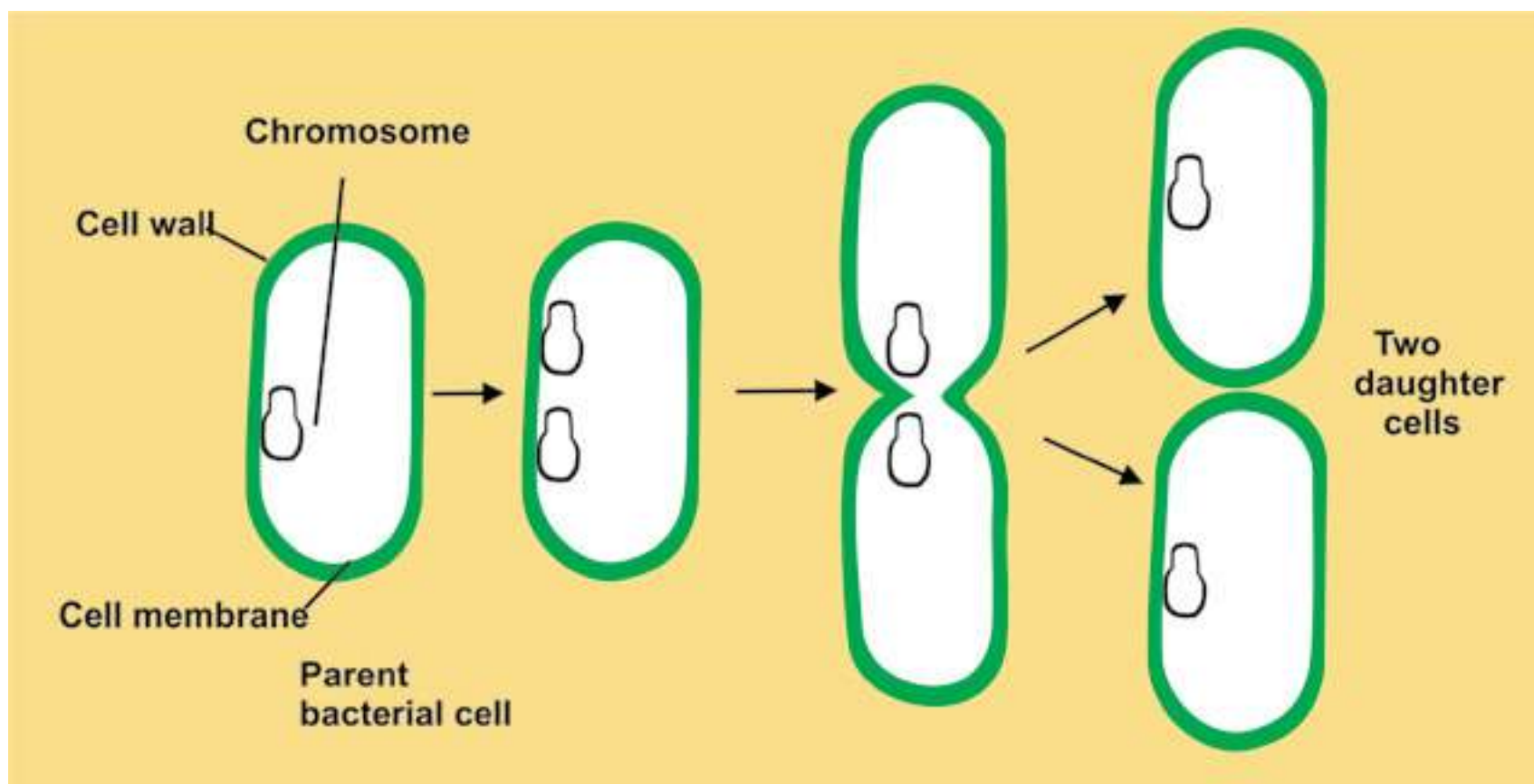

Fig. 6.6 Binary Fission in bacteria

- 1) Lag phase: It is phase of no growth. Bacteria prepare themselves for division.
- 2) Log phase: It is phase of rapid growth. Bacteria divide at exponential rate.
- 3) Stationary phase: Bacterial death rate is equal to bacterial rate of reproduction and multiplication.
- 4) Death/Decline phase: Bacteria start dying. Here the death rate is more than reproduction rate.

Bacteria lack traditional sexual reproduction and mitosis. However, some bacteria transfer genetic material from a donor bacterium to a recipient during a process called **conjugation**. Some conjugating bacteria use specialized **sex pili** to transfer genetic material. Conjugation produces new genetic combinations that may allow the resulting bacteria to survive under great variety of conditions.

IMPORTANCE OF BACTERIA

Ecological importa.ce

Bacteria are ecologically very important. They are highly adaptable as a group and are found nearly everywhere. They are able to decompose organic matter and play a significant role in the completion of cycles of nitrogen, phosphorus, sulfur and carbon.

Eco.omic Importa.ce

Bacteria are used in number of industries, including food, drugs (production of antibiotics and vaccines) and in biotechnology. Bacteria are also responsible for spoilage of food and vegetables. Many plant pathogens adversely affect the agricultural industry.

Medical Importa.ce

Bacteria are very common pathogens of humans. Approximately 200 species are known to cause diseases in humans. Many bacteria normally inhabit the bodies of man and other animals.

Co.trol of bacteria

Control of microorganisms is essential in home, industry as well as in medical fields . By controlling microorganisms one can prevent and treat diseases. Spoilage of foods and other industrial products can be inhibited by controlling microorganisms.

Microorganisms can be controlled by various methods.

Physical methods : In this, steam, dry heat, gas, filtration and radiation are used to control bacteria. The process in which we use physical agents to control bacteria/microorganism is known as **sterilization process**. Sterilization is destruction of all life forms.

High temperature is usually used in microbiological labs for control of microbes. Both dry heat and moist heat are effective. Moist heat causes coagulation of proteins and kills the microbes. Dry heat causes oxidation of chemical constituents of microbes and kills them.

Certain electromagnetic radiations below 300 nm are effective in killing of microorganisms. Gamma rays are in general used for sterilization process.

Heat sensitive compounds like antibiotics, seras,-hormones etc. can be sterilized by means of membrane filters.

Chemical methods: One can use **antiseptics, disinfectants** and **chemotherapeutic** agents for microbial control. Chemical substances used on living tissues that inhibit the growth of microorganism are called **antiseptics**.

The important chemical agents used for disinfection are oxidising and reducing agents. For example halogens and phenols, hydrogen peroxide, Potassium **permanganate**, alcohol and formaldehyde etc. inhibit the growth of vegetative cells and are used on nonliving materials.

Chemotherapeutic agents and **antibiotics** work with natural defense and stop the growth of bacteria and other microbes. These are Sulfonamides, tetracycline; penicillin, etc. They destroy or inhibit the growth of microorganisms in living tissues.

Microbicidal effect is one that kills the microbes immediately

Microbistatic inhibits the reproductive capacities of the cells and maintains the microbial population at constant size.

Modes of action of different chemical and physical agents of control vary. Damage can result malfunctions in cell wall, cell membranes, cytoplasmic enzymes, or nucleic acid.

Immunization and Vaccination : Methods of prevention and treatment that have been introduced to control microbial diseases include **immunization** (e.g. **vaccination**), **antisepsis** (procedures to eliminate or reduce the possibility of infection), **chemotherapy** and public health measures (e.g. water purification, sewage disposal, and food preservation).

Pasteur made many discoveries concerning the cause and prevention of infectious diseases. In 1880's he isolated the bacterium responsible for **chicken cholera**. He grew it in a pure culture. To prove that he really had isolated the bacterium responsible for this disease Pasteur made use of the fundamental techniques devised by Koch. He arranged experiments for a public demonstration in which he repeated an experiment that had been successful in many previous trials in his laboratory.

He inoculated healthy chicken with his pure cultures and waited for them to develop chicken cholera and die. But to his dismay, the chickens failed to get sick and die. Reviewing each step of the experiment, Pasteur found that he had accidentally used the cultures several weeks old instead of fresh one grown especially for the demonstration. He soon discovered that somehow bacteria could lose their virulence, or ability to produce disease, after standing and growing old. But these attenuated, or less virulent, bacteria could still stimulate the host (in this case the chicken) to produce antibodies, substances that protect the host (in this case the chicken) against infection due to subsequent exposure to the virulent organism.

Pasteur next applied this principle of inoculation with attenuated cultures to the prevention of anthrax, and again it worked. He called the attenuated cultures of bacterial **vaccine** (a term derived from the Latin **Vacca**, "cow") and immunization with attenuated cultures of bacteria, **vaccination**.

Pasteur honoured Edward Jenner (1749-1823), who had successfully vaccinated a boy against small pox in 1796. Jenner had learned that milkmaids who contracted cowpox from the cows, they milked, never subsequently contracted the much more virulent small pox. Accordingly he tested this hypothesis by inoculating young James Phipps first with cowpox causing material and later with small pox causing material. The boy did not get small pox.

Then Pasteur also made a vaccine for **hydrophobia**, or rabies, a disease transmitted to people by bites from rabid dogs, cats, and other animals.

USE AND MISUSE OF ANTIBIOTICS

Antibiotics is a Greek word (**Anti-against-and Bios life**). Antibiotics are the chemotherapeutic chemical substances which are used in treatment of infectious diseases. Antibiotics are synthesized and secreted by certain bacteria, actinomycetes and fungi. Today, some antibiotics are synthesized in the laboratory. However, their origins are living cells. To determine drug of choice, one must

know its mode of action, possible adverse side effects in the human beings.

Use antibiotics as prescribed by the physicians. Take dose at regular intervals and complete the treatment as advised by the doctor.

Massive quantities of antibiotics are being prepared and used, which are followed by the widespread problems of drug resistance in microorganisms. This results in an increasing resistance against disease treatments. Misused antibiotics can interact with the human metabolism and in severe cases can cause death of human beings. Misuse of antibiotic such as penicillin can cause allergic reactions. Similarly streptomycin can affect auditory nerve thus causing deafness. Tetracycline and its related compounds cause permanent discoloration of teeth in young children.

CHARACTERISTICS OF CYANOBACTERIA

The cyanobacteria are the largest and most diverse group of photosynthetic bacteria which was previously known as '**blue green algae**'. Cyanobacteria are true prokaryotes. They vary greatly in shape and appearance. They range in diameter from about 1-10µm and may be unicellular, exist as colonies of many shapes, or form **filaments** consisting of **trichomes** (chains of cells) surrounded by mucilaginous sheath. They have normal Gram-negative type cell wall. They lack flagella and often use gas vesicles to move in the water, and many filamentous species have gliding motility.

Their photosynthetic system closely resembles that of eukaryotes because they have chlorophyll a and photosystem II. They carry out oxygenic photosynthesis, i.e., they use water as an electron donor and generate oxygen during photosynthesis. Cyanobacteria use **phycobilins** as accessory pigments. Photosynthetic pigments and electron transport chain components are located in thylakoid membranes linked with particles called **phycobilisomes**. **Phycocyanin** pigment (blue) is their predominant phycobilin and CO₂ in them is assimilated through the Calvin cycle.

Reserve food material in cyanobacteria is **glycogen**. Cyanobacteria reproduce by binary fission, fragmentation. In cyanobacteria **hormogonia**, **akinetes** and **heterocysts** are present.

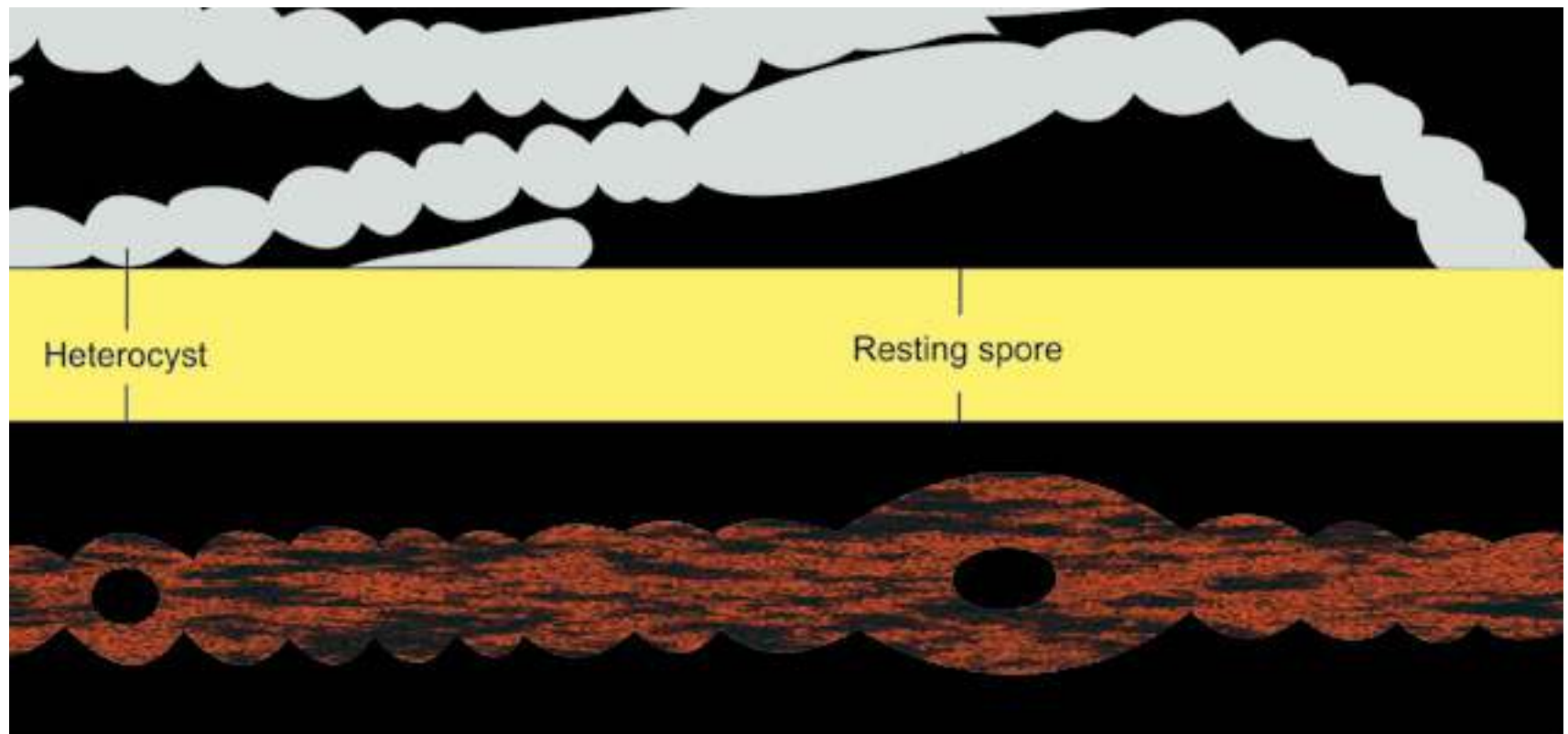
Fig. 6.8 Cyanobacterium *Anabaena*

ECONOMIC IMPORTANCE

They help in reclamation of alkaline soils. Cyanobacteria have **heterocysts**, which are helpful in the fixation of atmospheric nitrogen. They release O_2 in the environment due to their photosynthetic activity. *Oscillatoria* and few other cyanobacteria can be used as pollution indicator. They have symbiotic relationship with protozoa, fungi, and nitrogen fixing species form associations with angiosperms. They are photosynthetic partners in most of lichen association.

Super Blue green algae are basically expensive pond scum, in which cyanobacterium is a single celled organism that produces its own food through photosynthesis. It serves as a "complete whole food" which contain 60% protein with all essential amino acids in perfect balance.

Many species of cyanobacteria form **water blooms** where they often impart unpleasant smell and due to large amount of suspended organic matter water becomes unfit for consumption. Some species produce toxins that kill live stock and other animals that drink the water.

NOSTOC

Habitat a.d occurre.ce

Nostoc is common as terrestrial and subaerial cyanobacterium. It is widely distributed in alkaline soils and on moist rocks and cliffs. *Nostoc* forms a jelly like mass in which numerous filaments are embedded.

Structure

Trichomes are unbranched and appear beaded. Individual cells are mostly spherical but some times barrel shaped or cylindrical.

All cells in trichome are mostly similar in structure but at intervals are found slightly large , round, light yellowish thick walled cells called as **heterocysts**. Trichome mostly breaks near heterocyst and forms **hormogonia** and thus help in fragmentation.

Reproductio.

There is no sexual reproduction but it reproduces asexually by formation of hormogonia. Hormogonia are formed when filament break at different points into smaller pieces.This is due to death and decay of the ordinary cell or the heterocyst may serve as a breaking point. Reproduction can also be due to akinete formation. **Akinetes** are thick walled , enlarged vegetative cells which accumulate food and become resting cells. On arrival of favourable conditions they form normal vegetative cell.

EXERCISE

Q.1. Fill in the blanks.

- (i) A bacterial arrangement in packets of eight cells is described as a-----.
- (ii) The shape and arrangement of is diplococci
- (iii) Pili are tubular shafts in bacteria that serve as a means of-----.
- (iv) ----- are unusual type of bacteria that live in extreme habitats.
- (v) ----- is a bacterium that is photosynthetic.
- (vi) ----- is a cyanobacterium.
- (vii) ----- called as bloom forming organism.
- (vii) Use of antibiotics is one of the means of controlling ----- diseases.

Q.2. Short questions.

- (i) (a) Name general characteristics that could be used to define the prokaryotes.
(b) Do any other microbial groups besides bacteria have prokaryotic cells?
(c) In what habitats are bacteria found? Give some general means by which bacteria derive nutrients.
- (ii) (a) List functions that the cell membrane performs in bacteria.
(b) What are mesosomes and some of their possible functions?
- (iii) What is unique about the structure of bacterial ribosomes?
- (iv) Draw the three bacterial shapes.
- (v) Name a bacterium that has no cell wall.
- (vi) A gram stained discharge from an abscess shows cocci in irregular grape like clusters. What is the most likely genus of this bacterium
- (vii) Draw an outline and label (i) streptobacilli, (ii) diplococci, (iii) staphylococci.

- (viii) You observe a culture of predominantly round (presumably spherical) bacteria that though apparently fully divided, nevertheless have failed to separate, thus resulting in long chains of cells. What, generally, might you call such an arrangement?
- (ix) Match the following descriptions with the best answer.
- | | |
|---|---------------------|
| (a) Division in one plane; cocci arranged in pairs | (a) Bacillus |
| (b) Division in one plane; cocci arranged in chains | (b) Streptobacillus |
| (c) Division in two planes; cocci arranged in a square of four | (c) Spirochete |
| (d) Division in one plane; rods completely separate after division. | (d) Spirillum |
| (e) Division in one plane; rods arranged in chains. | (e) Vibrio |
| (f) A comma shaped bacterium | (f) Streptococcus |
| (g) A thin, flexible spiral. | (g) Staphylococcus |
| (h) A thick, rigid spiral. | (h) Diplococcus |
| | (i) Tetrad |
| | (j) Sarcina |

Q.3. Extensive Questions

- (i) Describe in detail the structure of bacterial cell wall, emphasizing Gram positive and Gram negative properties.
- (ii) Write an account of different methods used for controlling microbes.
- (iii) Discuss the role of antibiotics and immunization in controlling bacterial diseases. What problem can arise due to misuse of antibiotics.
- (iv) Describe general characteristics of Cyanobacteria with special reference to Nostoc.

- (v) Write Notes on :
- (a) Koch's postulates
 - (b) Shape of bacteria
 - (c) Flagella and pili
 - (d) Growth in bacteria.

CHAPTER



**THE KINGDOM
PROTISTA
(OR PROTOCTISTA)**

*Animation 7.1: Kingdom Protista
Source & Credit: media.giphy*

The Kingdom Protista consists of a vast assortment of primarily aquatic eukaryotic organisms whose diverse body forms, types of reproduction, modes of nutrition and lifestyles make them difficult to characterize. Basically, this kingdom is defined by exclusion i.e., all members have characteristics that exclude them from the other four kingdoms.

All protists are eukaryotic and have evolved from prokaryotes. Another reason for creating a separate kingdom arises from the difficulty in placing certain eukaryotic organisms in the appropriate kingdom. This difficulty is a consequence of the fact that the other eukaryotic kingdoms have their evolutionary origin in kingdom Protista. The other eukaryotic kingdoms Plantae, Fungi, and Animalia arose from protists in various ways.

The protists are unicellular, colonial or simple multi cellular organisms that possess a eukaryotic cell organization. Eukaryotic cells, the unifying feature of protists, are common to complex multi-cellular organisms belonging to the three eukaryotic kingdoms (Fungi, Plantae and Animalia) but clearly differentiate protists from members of the prokaryotic kingdom (Monera). Unlike plants and animals, however, protists do not develop from a blastula or an embryo.

The kingdom protista contains four major groups of eukaryotic organisms which are : single celled protozoans, unicellular algae, multicellular algae, slime molds and oomycetes.

HISTORICAL PERSPECTIVE

In 1861, John Hogg proposed the kingdom Protoctista for microscopic organisms. In 1866, Ernst Haeckel suggested creating the Kingdom Protista to include bacteria and other microorganisms (such as *Euglena*) that kingdom. He, however, separated blue green algae and bacteria (prokaryotes) from nucleated protists and placed them in a separate group he called Monera, within the kingdom Protista.

In 1938, Herbert Copeland elevated the prokaryotes to kingdom status, thus separating them from Protista. In five kingdom system of Robert Whittaker (1969) only unicellular eukaryotes were placed in kingdom Protista. Currently this kingdom also includes colonial and simple multicellular eukaryotes as well. Margulis and Schwartz (1988) modified the five kingdom system. Protista or Protoctista is one of the five kingdoms.

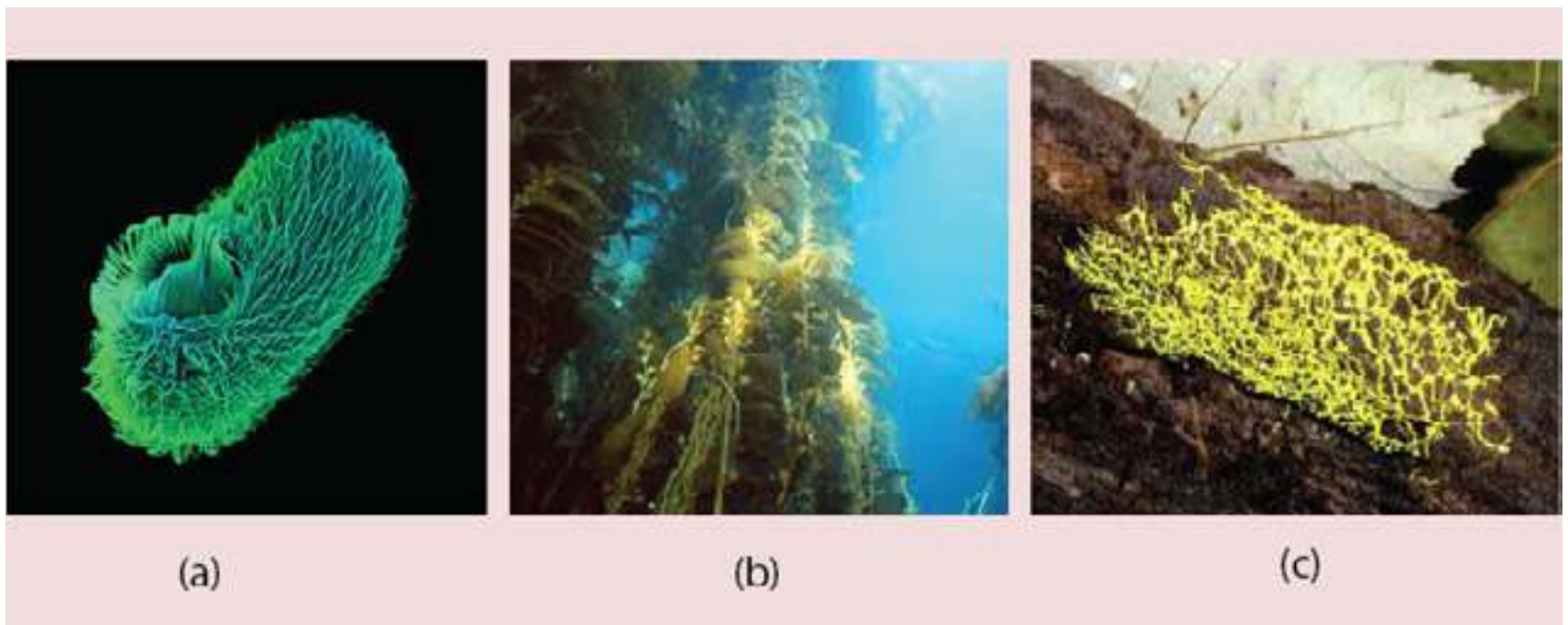

Fig 7.1 The kingdom protista includes such diverse species as (a) single celled ciliated protozoan, (b) giant brown algae (kelps) and (c) slime molds.

DIVERSITY AMONG PROTISTA

During the course of evolutionary history, organisms in the kingdom protista have evolved diversity in their (a) size and structure, (b) means of locomotion, (c) ways of obtaining nutrients, (d) interactions with other organisms, (e) habitat and (f) modes of reproduction. Diversity is exhibited by all of the major protist groups (Fig. 7.1).

Based on the diversity, most biologists regard the protists kingdom as a polyphyletic group of organisms; that is, the protists probably do not share a single common ancestor. Margulis and Schwartz have listed 27 phyla to accommodate this diverse assemblage of organisms.

MAJOR GROUPS OF PROTISTA

1. Protozoa : Animal-like Protists

All protozoans are unicellular. Most ingest their food by endocytosis. A summary of protozoan diversity is given in Table 7.1.

Table 7.1 Some groups of protozoa

Common Name	Form	Locomotion	Examples
Amoebae	Unicellular, no definite shape	Pseudopods	<i>Amoeba, Entamoeba,</i>
Zooflagellates	Unicellular. some colonial	One or more Flagella	<i>Trypanosoma, Euglena,</i>
Actinopods	Unicellular	Pseudopods	Radiolarians
Foraminifera	Unicellular	Pseudopods	Forams
Apicomplexans	Unicellular	None	<i>Plasmodium</i>
Ciliates	Unicellular	Cilia	<i>Paramecium, Vorticella,</i> <i>Stentor</i>

(a) Amoebae:

This group includes all free living freshwater, marine and soil amoebae as well as those that are parasites of animals. Amoebae lack flagella and move by forming specialized cytoplasmic projections called pseudopodia (false feet). (Fig. 7.2).

The intestinal parasite, *Entamoeba histolytica*, causes; amoebic dysentery in humans.



Fig. 7.2 The flowing pseudopods of Amoeba constantly change shape as the organism moves and feeds.

Animation 7.2: Amoeba
Source and Credit: Gifsoup



The Giant Amoeba

The giant amoeba *Pelomyxa palustris* may be the most primitive of all eukaryote like forms. This species has multiple membrane-bound nuclei but none of the other organelles found in all other eukaryotes. The giant amoebas obtain energy from methanogenic bacteria, which reside inside them. Giant amoebas inhabit mud at the bottom of freshwater ponds, where they contribute to the degradation of organic molecules

Animation 7.3: Amoeba
Source and Credit: ironic

(b) Zooflagellates:

These protists are mostly unicellular (a few are colonial) organisms with spherical or elongated bodies with a single central nucleus. They possess from one to many long, whip-like flagella that enable them to move. Flagellates move rapidly, pulling themselves forward by lashing flexible flagella, that are usually located at the anterior end.

Flagellates obtain their food either by ingesting living or dead organisms or by absorbing nutrients from dead or decomposing organic matter. They may be free-living, symbionts or parasites. Trichonymphas are complex, specialized flagellates with many flagella which live as symbionts in the guts of termites and help in the digestion of dry wood (Fig. 7.3a)

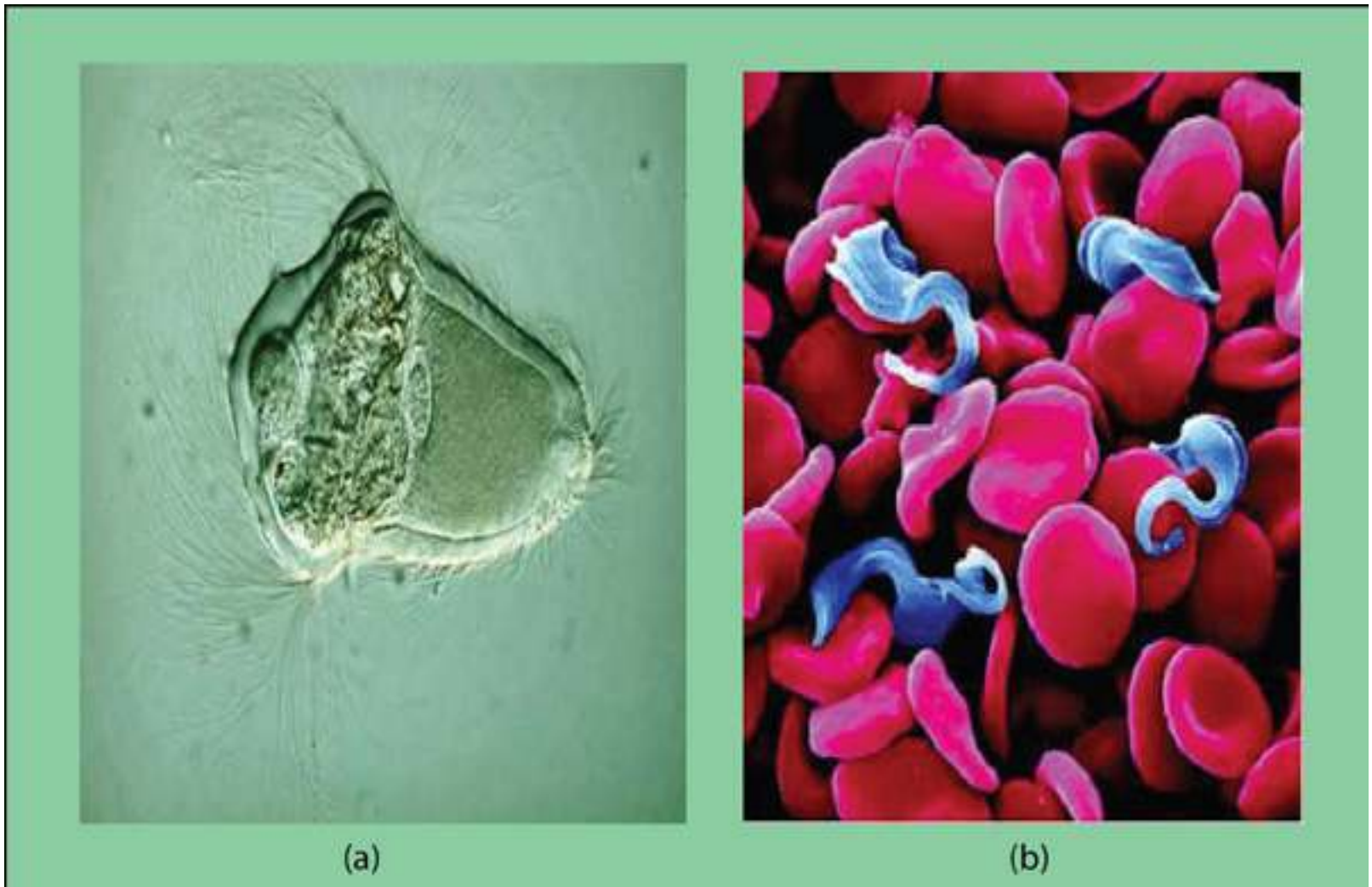

Fig. 7.3 Zooflagellates (a) *Trichonympha* has hundreds of flagella (b) *Trypanosoma* causes sleeping sickness.

Animation 7.4: *Paramecium* Contractile Vacuole
Source and Credit: gif2fly

Parasitic flagellates cause diseases. For example *Trypanosoma* is a human parasite causing African sleeping sickness. It is transmitted by the bite of infected tsetse fly (Fig. 7.3 b)

Choanoflagellates are sessile marine or freshwater flagellates which are attached by a stalk and their single flagellum is surrounded by a delicate collar. They are of special interest because of their striking resemblance to collar cells in sponges (Fig. 7.4).

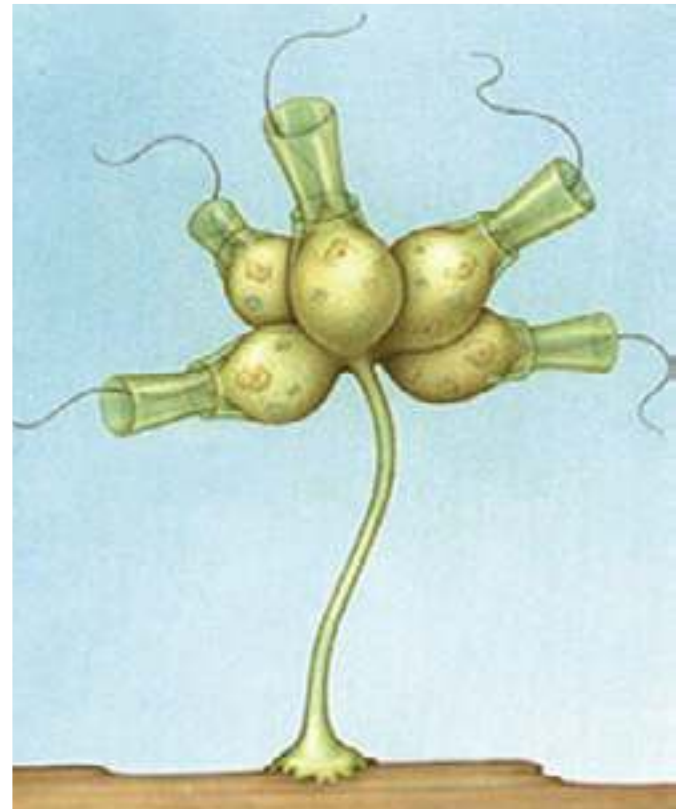
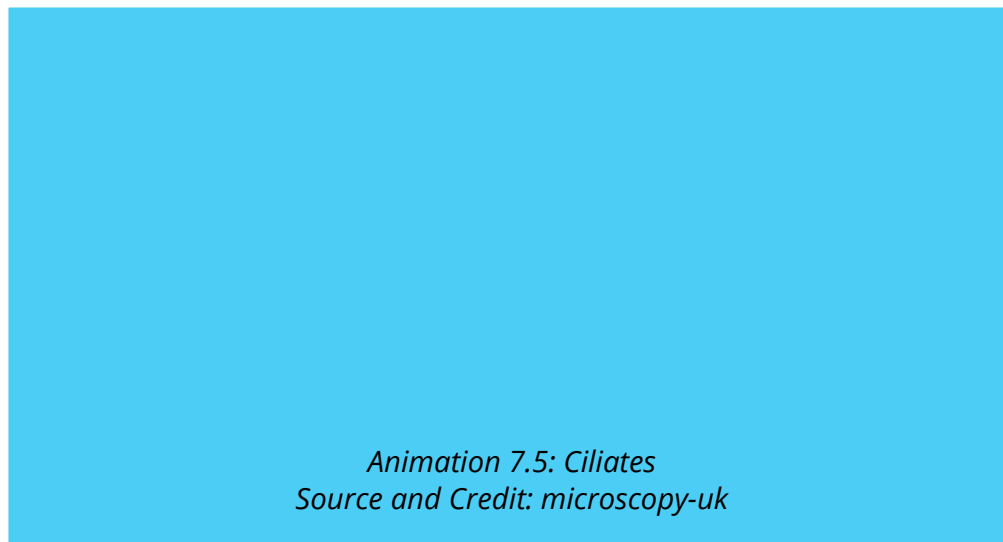

Fig. 7.4 A colonial choanoflagellate

(c) Ciliates

Ciliates are unicellular organisms with a flexible outer covering called a pellicle that gives them a definite but changeable shape. In *Paramecium*, the surface of the cell is covered with several thousand fine, short, hair-like structures called cilia. The cilia beat in such a precisely coordinated fashion that the organism can go forward, can also go back and turn around.

Some ciliates are sessile and remain attached to a rock or other surface. Their cilia set up water currents that draw food towards them. Most ciliates ingest bacteria or other tiny protists.



Animation 7.5: Ciliates
Source and Credit: microscopy-uk



Fig. 7.5 (a) *Paramecium*, conjugating individuals (b) *Stentor*, a sessile ciliate.

Water regulation in freshwater ciliates is controlled by special organelles called contractile vacuoles. Ciliates differ from other protozoans in having two kinds of nuclei. One or more small diploid micronuclei that function in sexual process, and a large, polyploid macronucleus that controls cell metabolism and growth. Most ciliates are capable of a sexual process called conjugation. During conjugation two individuals come together and exchange genetic material (Fig. 7.5).

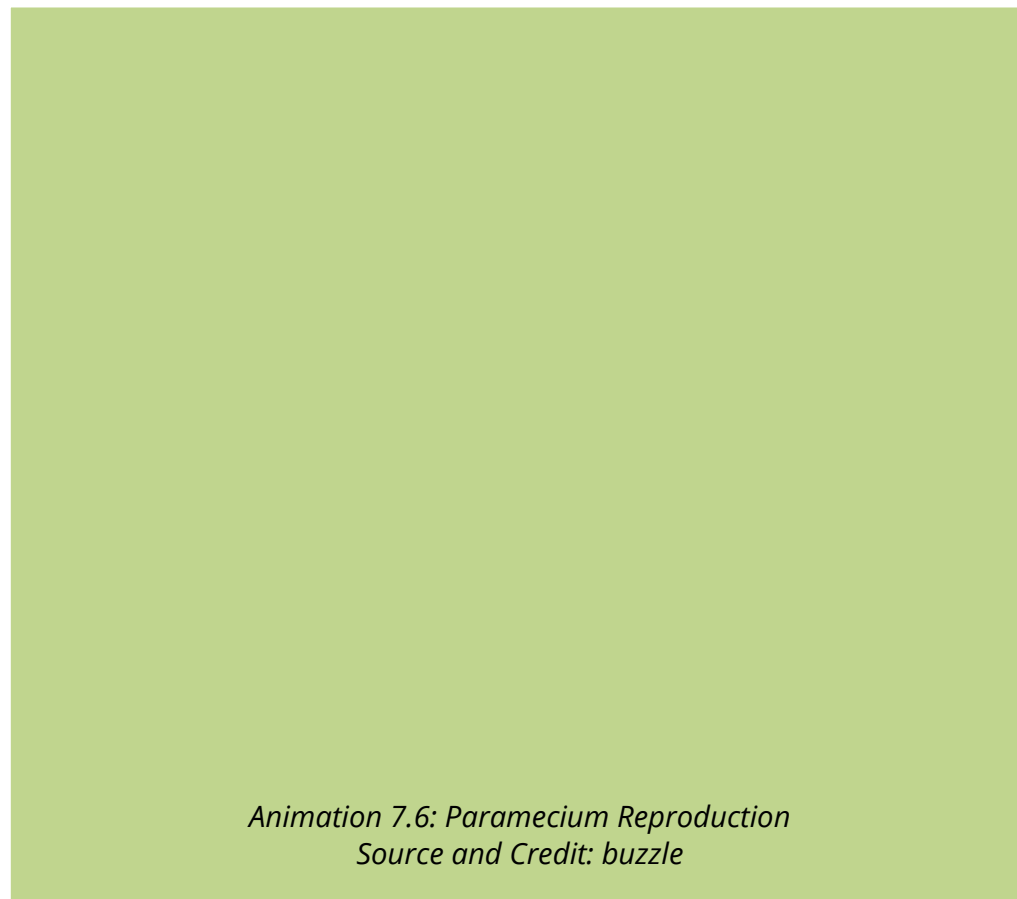

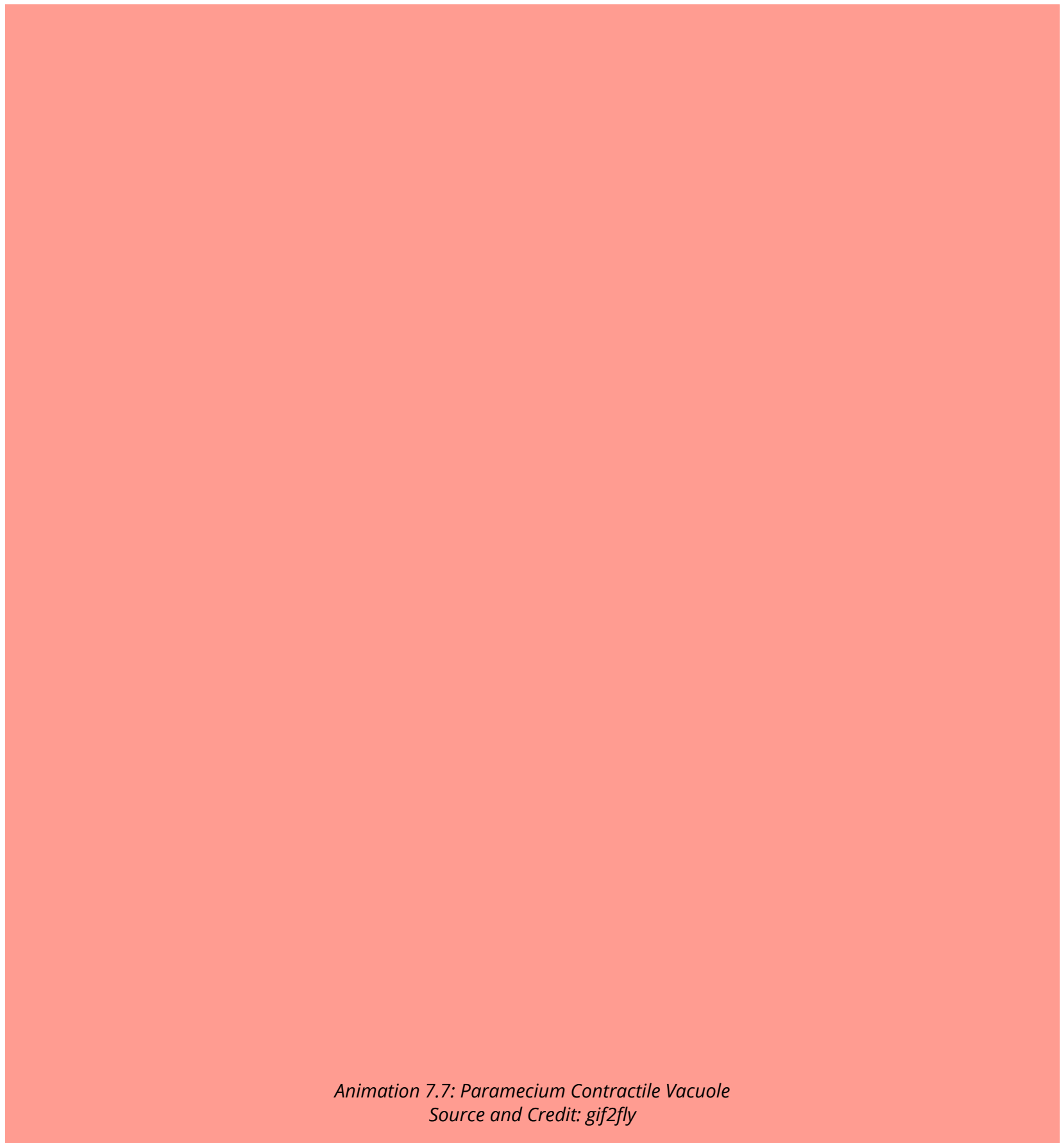

(d) Foraminiferans and Actinopods

These marine protozoans produce shells (or tests). Tests of foraminifera are made of calcium whereas those of actinopods are made of silica. The shells or tests contain pores through which cytoplasmic projections can be extended. These cytoplasmic projections form a sticky, interconnected net that entangles prey. Dead foraminiferans sink to the bottom of the ocean where their shells form a grey mud that is gradually transformed into chalk. Foraminiferans of the past have created vast limestone deposits.

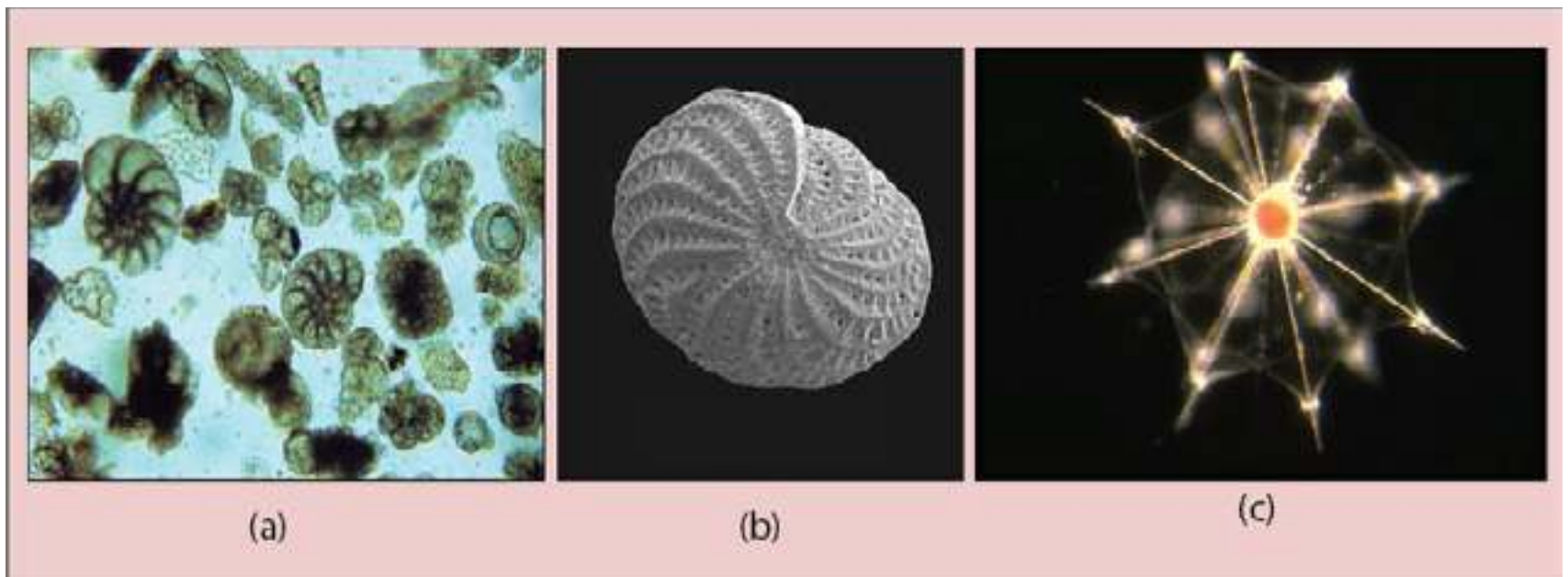

Fig. 7.6 (a) Foraminiferan tests have (a) beautiful geometric patterns and (b) pores through which cytoplasmic projections are extended (c) Radiolarians are actinopods with glassy shells.

(e) Apicomplexans

Apicomplexans are a large group of parasitic protozoa, some of which cause serious diseases such as malaria in humans. Apicomplexans lack specific structures for locomotion but move by flexing. At some stage in their lives, they develop a spore, a small infective agent transmitted to the next host. Many Apicomplexans spend part of their life in one host and part in a different host species (Fig. 7.7).

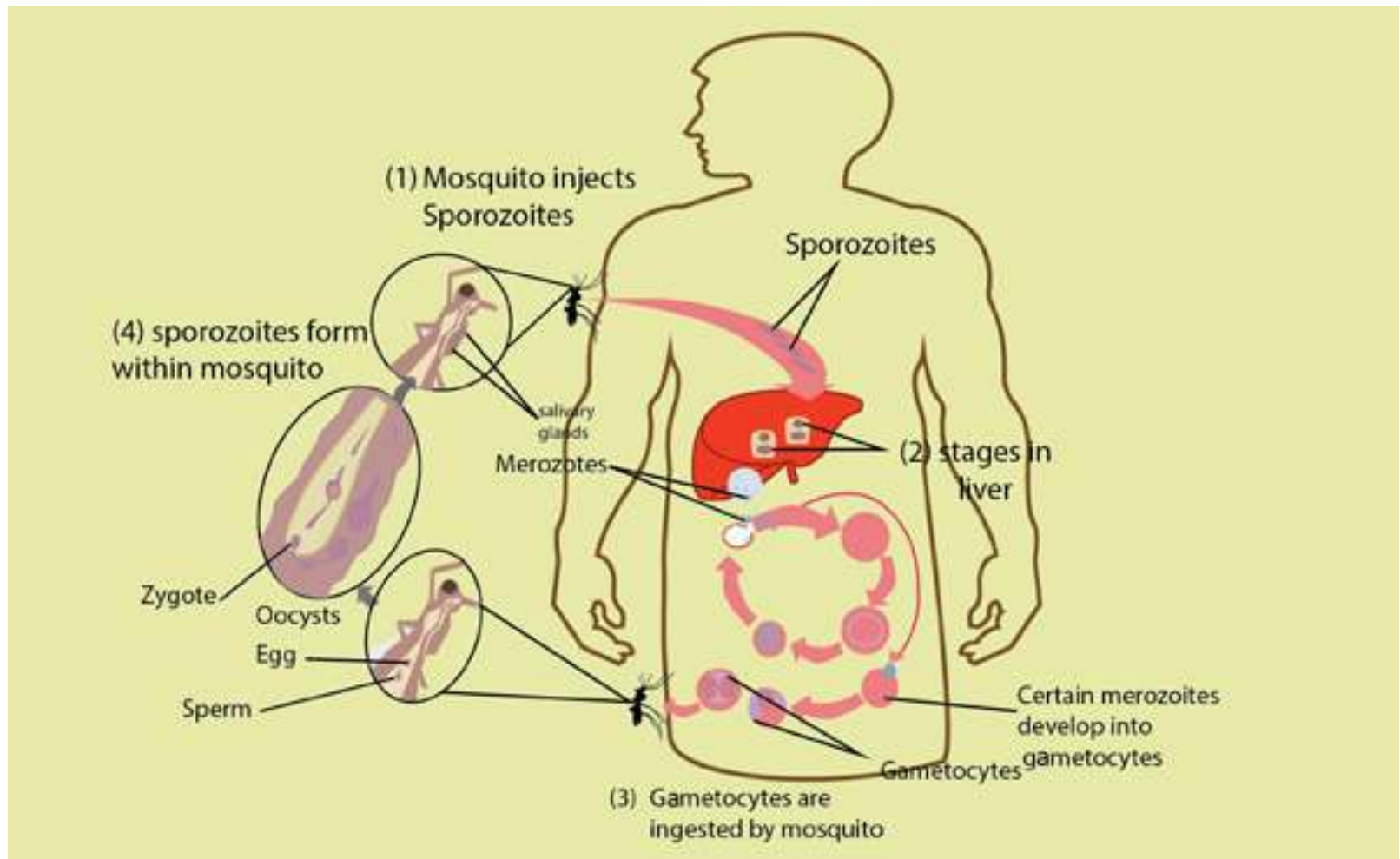

Fig. 7.7 The life cycle of the malarial parasite (*Plasmodium*).

Plasmodium, the apicomplexan that causes malaria, enters human blood through the bite of an infected female *Anopheles* mosquito. *Plasmodium* first enters liver cells and then red blood cells, where it multiplies. When each infected red blood cell bursts, many new parasites are released. The released parasites infect new red blood cells, and the process is repeated. The simultaneous bursting of millions of red cells causes the symptoms of malaria; a chill, followed by high fever caused by toxic substances that are released and affect other organs of the body (Fig. 7.7).

2. The Algae: Plant like protists

Algae (singular alga) are photosynthetic protists, carrying out probably 50 to 60 percent of all the photosynthesis on earth (plants account for most of the rest).

Algae differ from the plants in their sex organs which are unicellular and the zygote is not protected by the parent body. A plant zygote, on the other hand, grows into a multicellular embryo that is

protected by parental tissue.

Algae exhibit a remarkable range of growth forms. Some are unicellular; others are filamentous. Filaments are composed either of distinct cells or coenocytes (multinucleate structures that lack cross-walls), still others (e.g. seaweeds) are multicellular and intricately branched or arranged in leaf-like extensions. A body which is not differentiated into true roots, stems and leaves and lacks xylem & phloem is called a **thallus**.

In addition to green chlorophyll a, yellow and orange carotenoids, which are photosynthetic pigments are found in all algae, other algal phyla possess a variety of other pigments (such as xanthophylls and phycoerythrin) that are also important in photosynthesis. Classification into phyla is largely based on their pigment composition.

Algal life cycles show extreme variation, but all algae except members of the phylum Rhodophyta (red algae) have forms with flagellated motile cells in at least one stage of their life cycle.

Almost all algae are aquatic. When actively growing, algae are restricted to damp or wet environments, such as the ocean; freshwater ponds, lakes, and streams; hot springs; polar ice; moist soil, trees, and rocks. Table 7.2 summarizes the classification of algae.

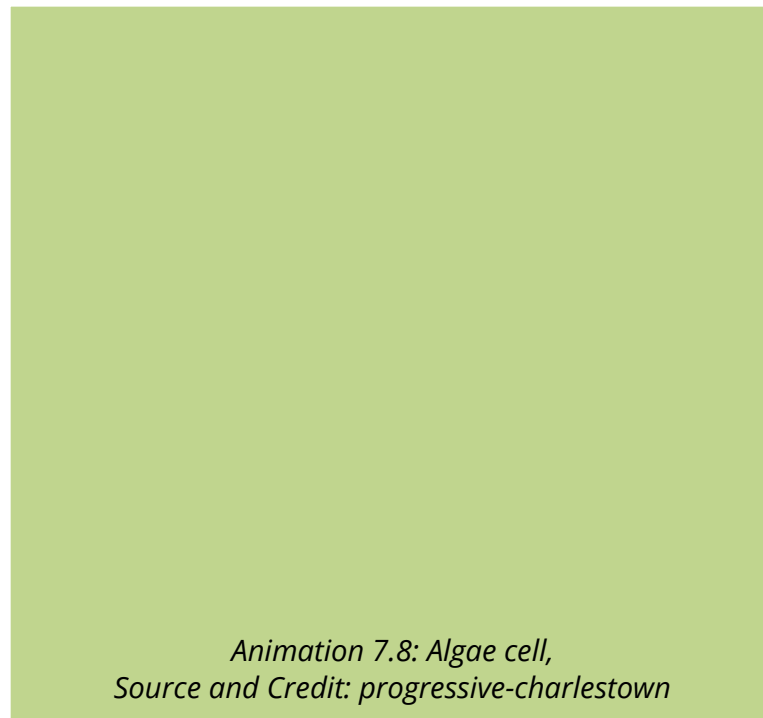

Table 7.2 Classification of the photosynthetic Protoctists

Phylum	Common name	Form	Locomotion	Pigments	Examples
Euglenophyta	Euglenoids	Unicellular	Two flagella one long one short	Chl. <i>a</i> , Chl. <i>b</i> Carotenoids	<i>Euglena</i>
Pyrrophyta	Dinoflagellates	Unicellular	Two flagella	Chl. <i>a</i> , Chl. <i>c</i> Carotenes including Fucoxanthin	<i>Gonyaulax</i> , <i>Ceratium</i>
Chrysophyta	Diatoms	Usually unicellular	Usually none	Chl. <i>a</i> , Chl. <i>c</i> Carotenes including Fucoxanthin	<i>Diatoma</i> , <i>Frequilaria</i> <i>Pinnularia</i>
Phaeophyta	Brown algae	Multicellular	Two flagella on reproductive cells	Chl. <i>a</i> , Chl. <i>c</i> Carotenes including Fucoxanthin	<i>Fucusi</i> <i>Macrocvstis</i>
Rhodophyta	Red algae	Multicellular or unicellular	None	Chl. <i>a</i> , carotenes Phycoerythrin	<i>Chondrus</i> <i>Polysiphonia</i>
Chlorophyta	Green algae	Unicellular, colonial, multicellular	Most have flagella	Chl. <i>a</i> , Chl. <i>b</i> . carotenes	<i>Chlorella</i> , <i>Ulva</i> , <i>Acetabularia</i> <i>Spirogyra</i>

Animation 7.9: Euglenam
Source and Credit: microscopy-uk

(I) The Euglenoids

Euglenoids have at various times been classified in the plant kingdom (with algae) and in animal kingdom (in protozoans). Based on molecular data, euglenoids are thought to be closely related to zooflagellates. They are plant like in their pigments. However, some photosynthetic euglenoids lose their chlorophyll when grown in dark and obtain their nutrients heterotrophically by ingesting organic matter. Other species of euglenoids are always colourless and heterotrophic (Fig. 7.8).

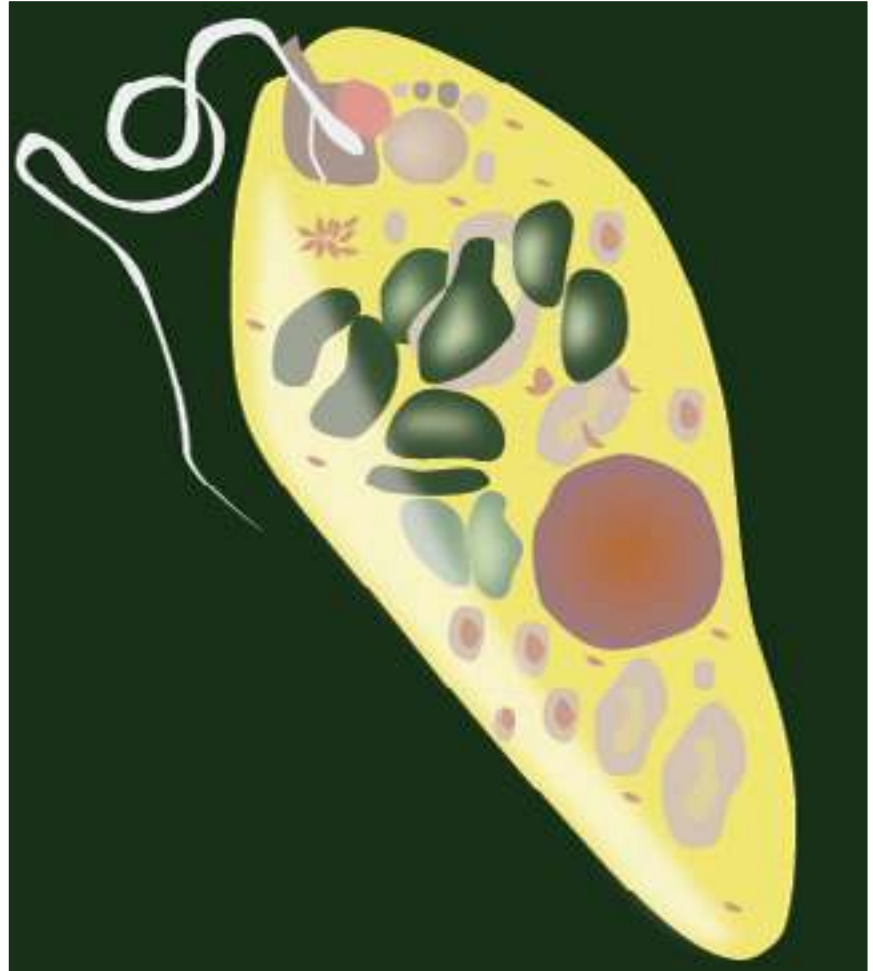

Fig 7.8 : Euglenoids have special evolutionary significance as they resemble with plants and green algae in having similar pigments and, on the other hand, are also related One of the most unusual protist to zooflagellates.

*Animation 7.10: Euglenoids,
Source and Credit: gifsoup*



(ii) Dinoflagellates

One of the most unusual protist phyla is that of dinoflagellates. Most dinoflagellates are unicellular. Their cells are often covered with shells of interlocking cellulose plates impregnated with silicates.

Ecologically, dinoflagellates are one of the most important groups of producers (second only to diatoms) in marine ecosystem. Dinoflagellates are known to have occasional population explosions or blooms. These blooms frequently colour the water orange, red or brown and are known as red tides (Fig. 7.9).

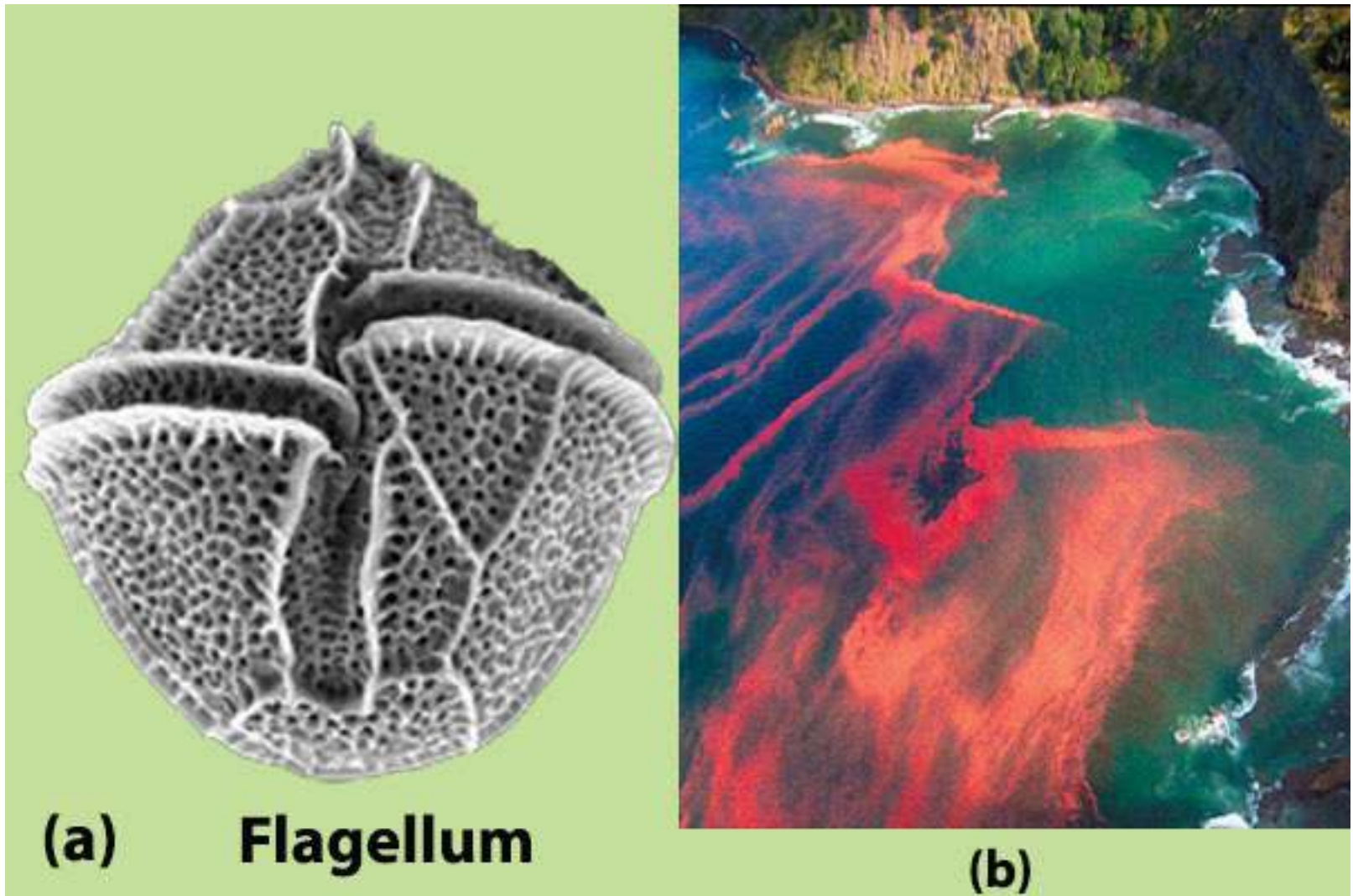
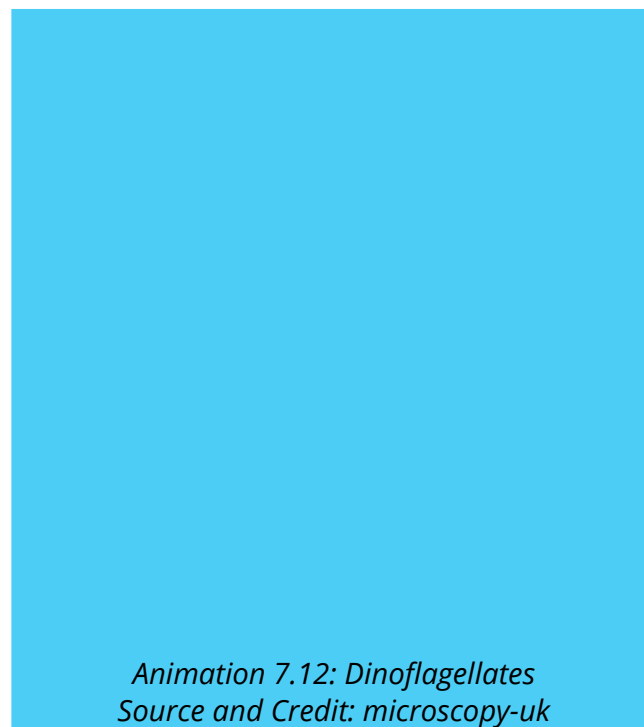

Fig. 7.9 (a) A dinoflagellate showing cellulose plates in the shell and flagella located in the grooves, (b) A red tide.



(iii) Diatoms

The cell wall of each diatom consists of two shells that overlap where they fit together, much like a petri dish. Silica is deposited in the shell, and this glasslike material is laid down in intricate patterns.



Fig. 7.10 Diatoms have silica shells with extremely beautiful symmetrical patterns

Diatoms are the major producers in the aquatic (marine and freshwater) ecosystems because of their extremely large numbers. Diatoms are very important in aquatic food chains (Fig. 7.10).

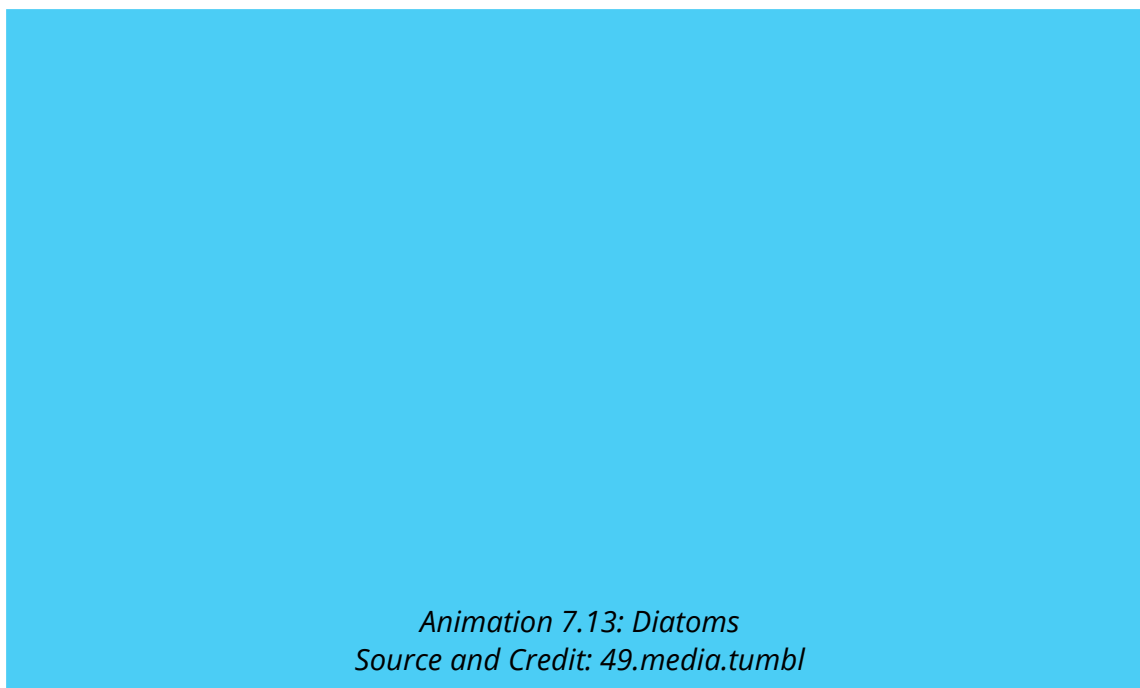

*Animation 7.13: Diatoms
Source and Credit: 49.media.tumblr*



(iv) Brown Algae

Brown algae include the giants of the protist kingdom. All brown algae are multicellular and range from a few centimeters to approximately 75 meters in length. The largest brown algae, called the kelps are tough and leathery in appearance. They possess leaflike blades, stemlike stipes, and rootlike anchoring holdfast. Brown algae are common in cooler marine waters, especially along rocky coastlines in the intertidal zone (Fig. 7.11).

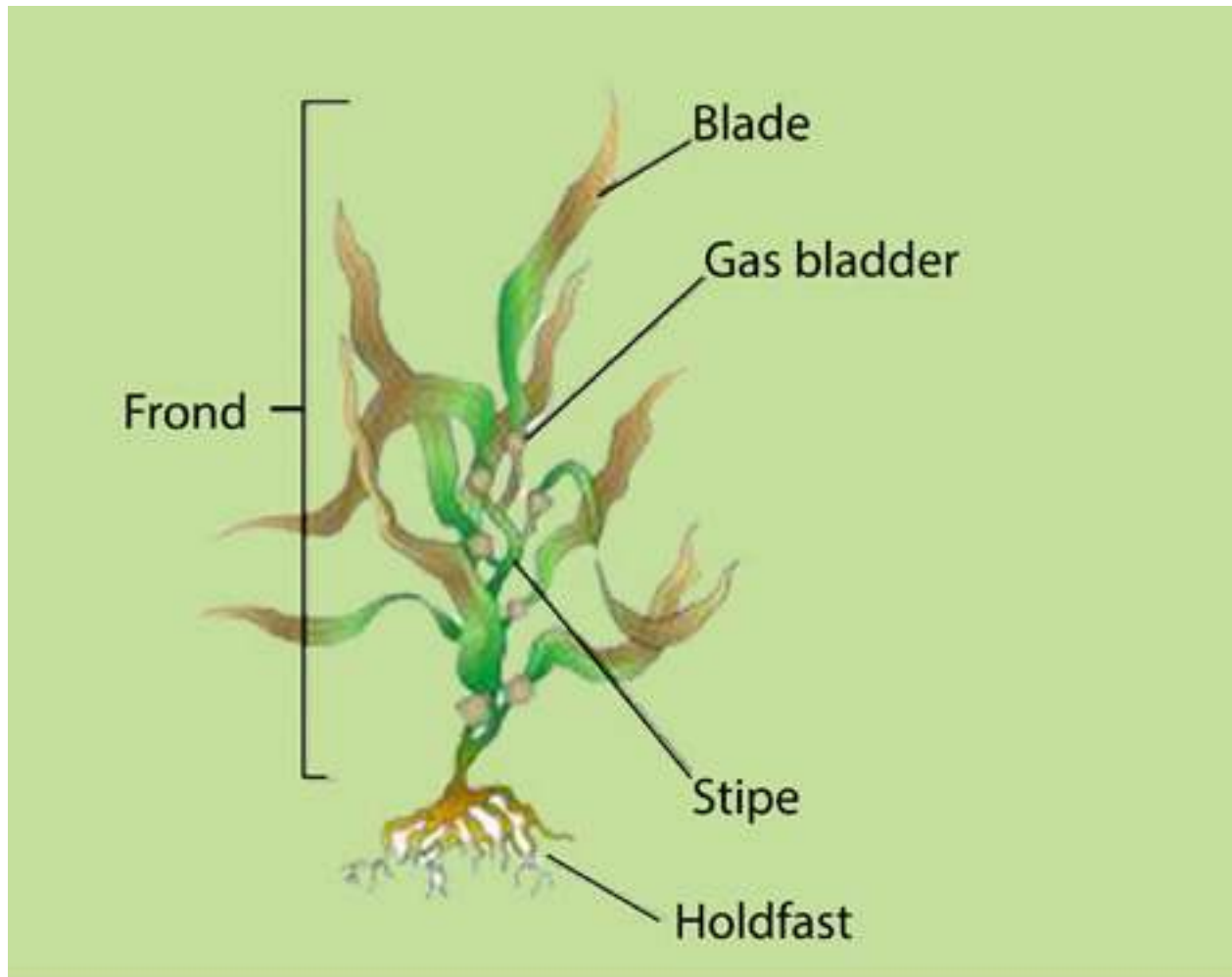

Fig. 7.11 Laminaria, a brown alga showing blades, stipes and holdfast



(v) Red Algae

The multicellular body form of red algae is commonly composed of complex interwoven filaments that are delicate and feathery. A few red algae are flattened sheets of cells. Most multicellular red algae attach to rocks or other substances by a basal holdfast. Some red algae incorporate calcium carbonate in their cell walls from the ocean and take part in building coral reefs alongwith coral animals (Fig. 7.12).



Fig. 7.12 Polysiphonia is a representative red alga with world wide distribution

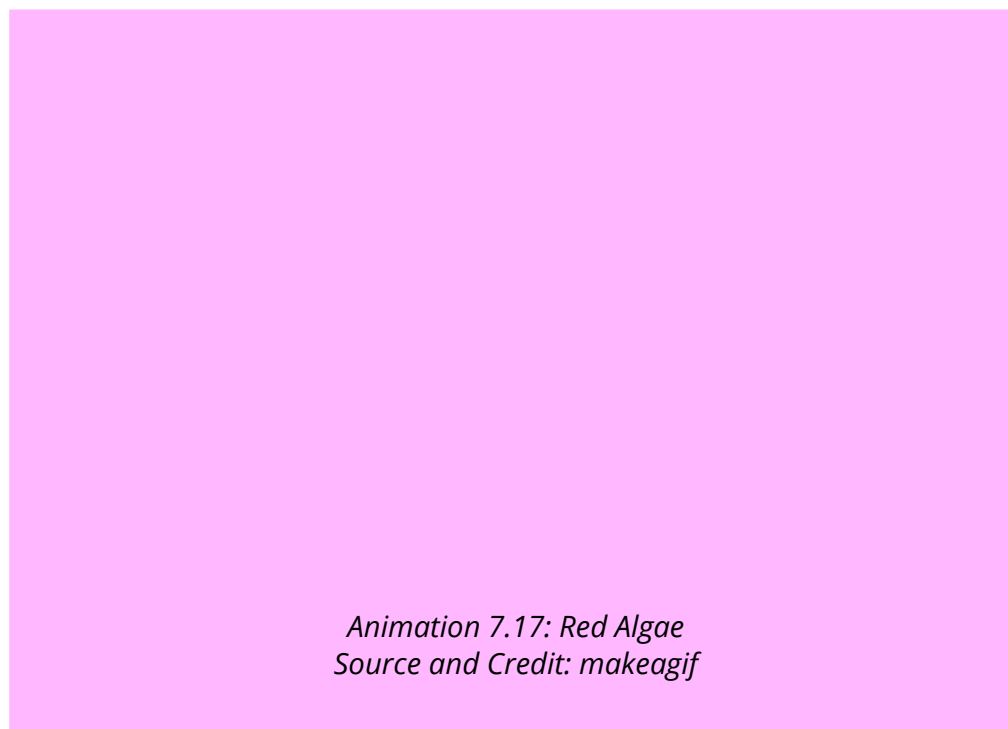
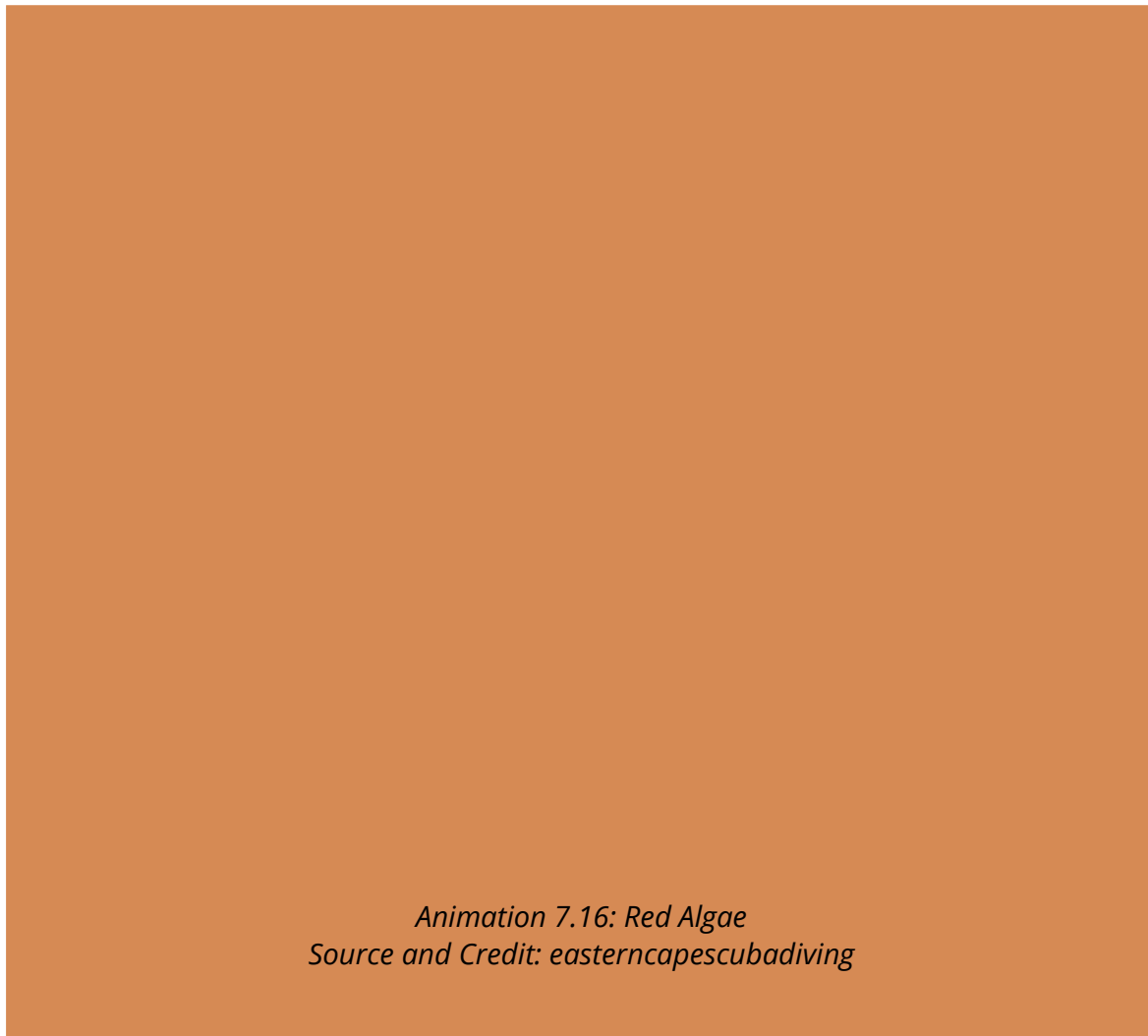

(vi) Green Algae

Green algae have pigments, energy reserve products, and cell walls that are identical to those of plants. Green algae are photosynthetic, with chlorophyll a, chlorophyll b, and carotenoids present in the chloroplasts. Their main energy reserves are stored as starch. Most green algae possess cell walls with cellulose. Because of these and other similarities it is generally accepted that plants arose from ancestral green algae. Evidence from RNA sequencing also indicates that green algae and the plants form a monophyletic lineage (Fig. 7.13).



Animation 7.18: Green Algae
Source and Credit: easterncapescubadiving

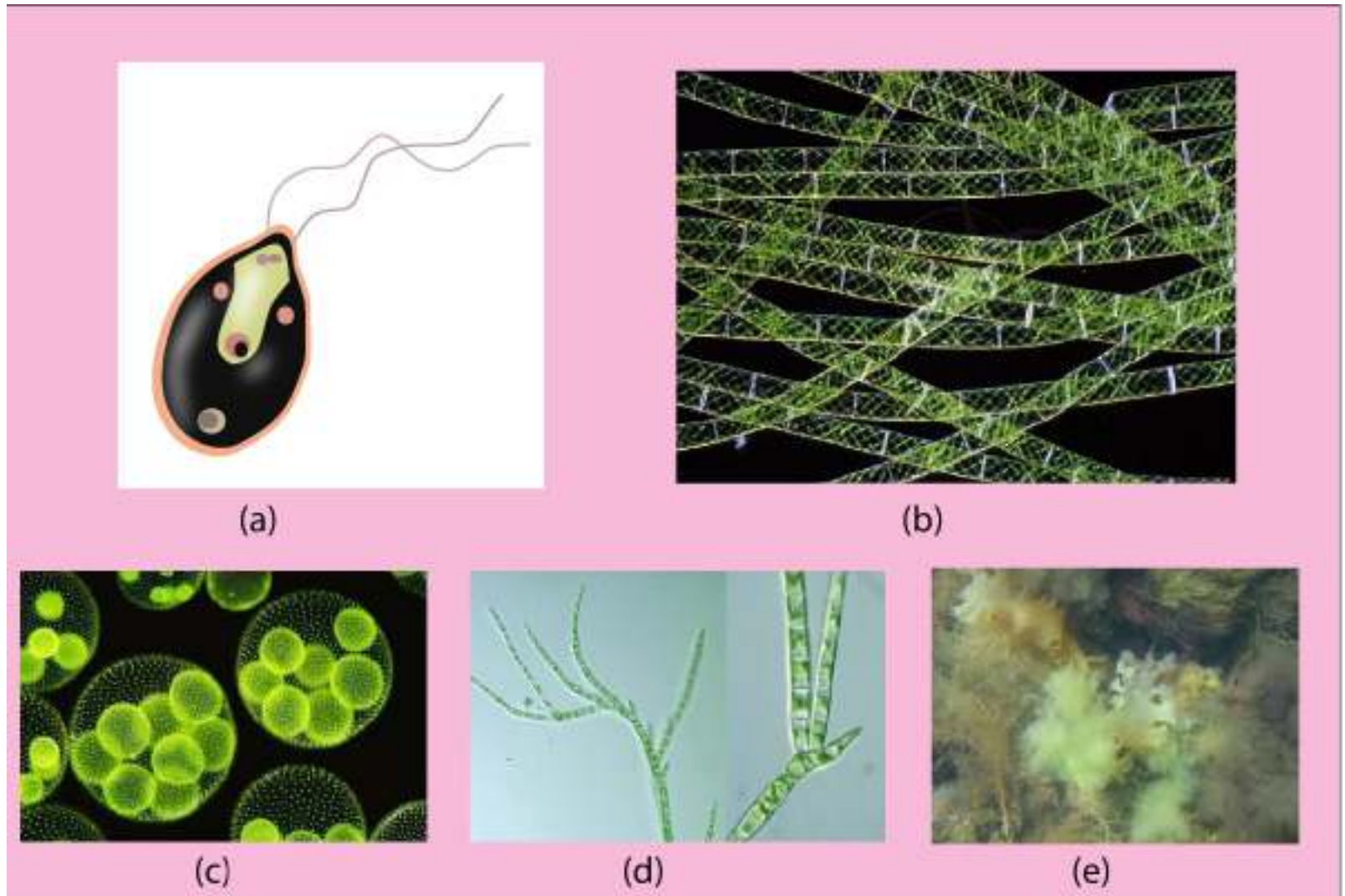
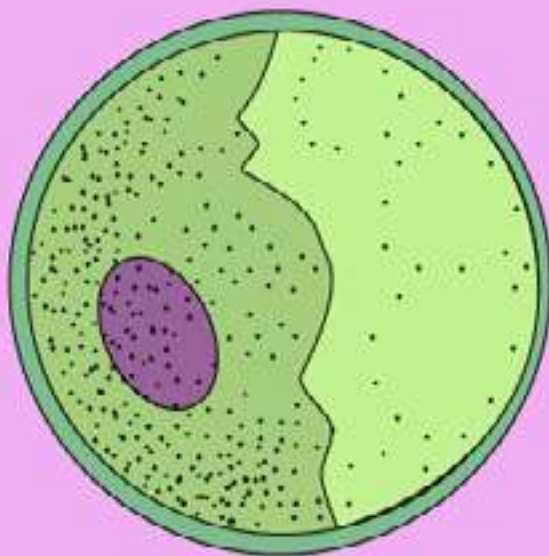

Fig. 7.13 Green algae exhibit diverse forms, (a) Unicellular *Chlamydomonas* (b) *Desmids* have cells with two halves. (c) Colonial *Volvox* (d) Filamentous *Spirogyra* (e) *Ulva*, having sheet like body.



Chlorella is a unicellular non-motile green alga. Its habitat is fresh water ponds and ditches. It is easily cultured and has been used as an experimental organism in research on photosynthesis as well as being investigated as an alternate source of food.

Importance of Algae

Algae have great economic and environmental importance for us. Some algae such as kelps are edible and may be used to overcome shortage of food in the world. Marine algae are also source of many useful substances like algin, agar, carrageenan, and antiseptics. Algae are major producers of the aquatic ecosystem, thus they play a basic role in food chains, providing food and oxygen to other organisms.

3. FUNGUS-LIKE PROTISTS

Some protists superficially resemble fungi in that they are not photosynthetic and some have bodies formed of threadlike structures called hyphae. However, funguslike protists are not fungi for several reasons. Many of these protists have centrioles and produce cellulose as a major component of their cell walls, whereas fungi lack centrioles and have cell walls of chitin. Two major groups of fungus-like protists are : Slime molds and water molds (oomycotes).

(i) Slime molds or Myxomycota

The feeding stage of a slime mold is a plasmodium, a multinucleate mass of cytoplasm that can grow to 30 cm (1 ft) in diameter. The plasmodium, which is slimy in appearance, streams over damp,

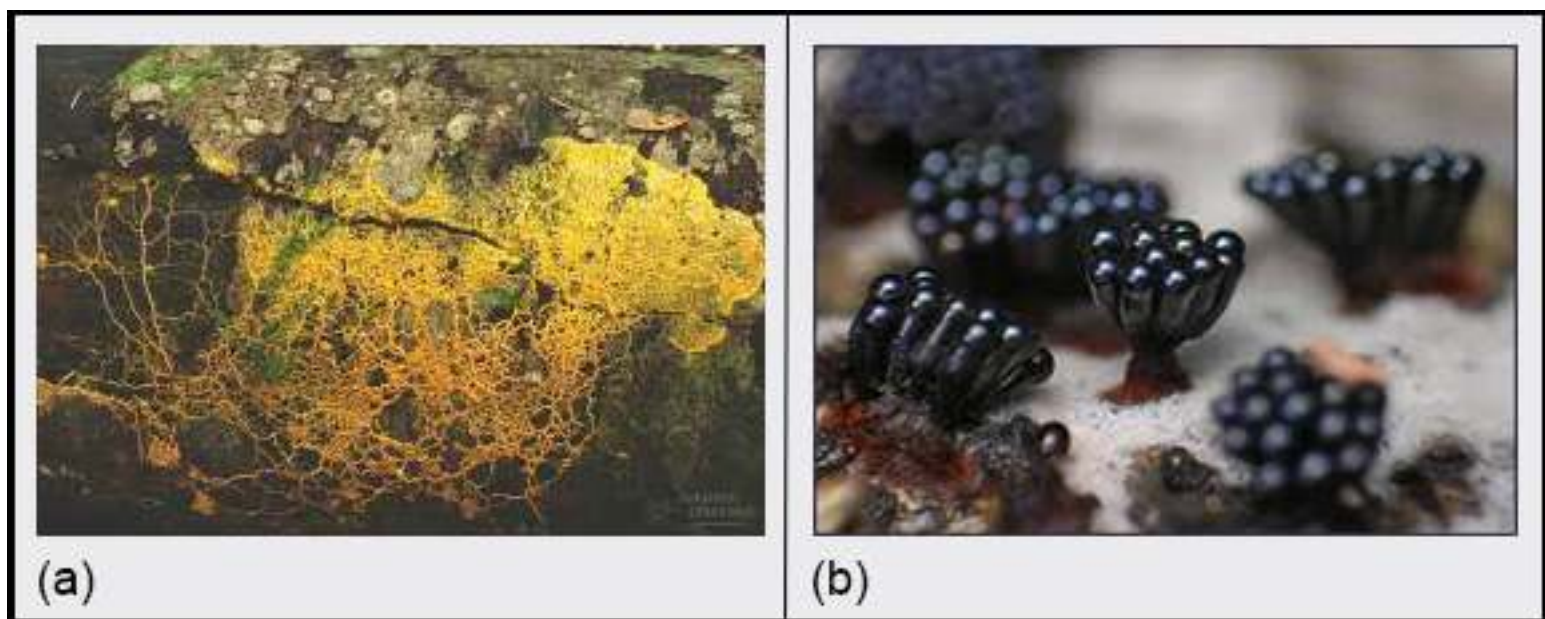
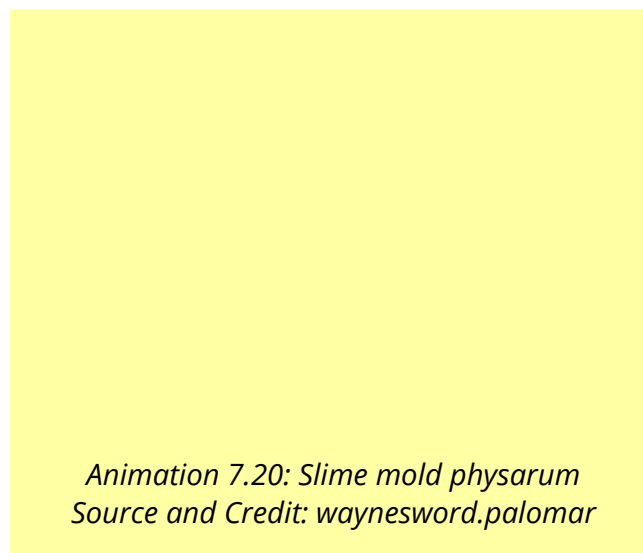
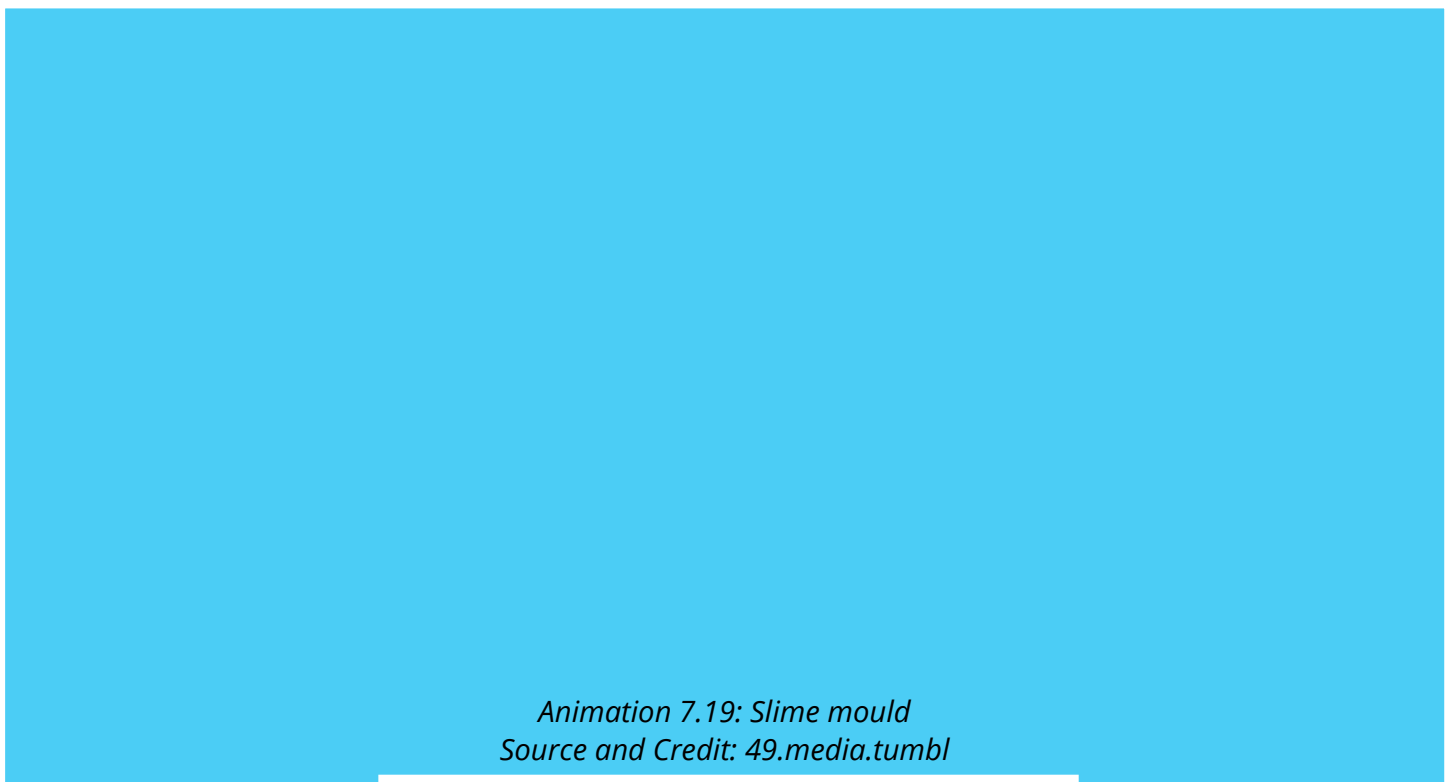

Fig. 7.14 Slime mold **Physarum** (a) The plasmodium is a naked mass of cytoplasm having many nuclei. (b) Reproductive structures are stalked sporangia.

decaying logs and leaf litter. It often forms a network of channels that cover a large surface area. As it creeps along, it ingests bacteria, yeasts, spores and decaying organic matter (Fig. 7.14).

During unfavourable condition, slime mold forms resistant haploid spore by meiosis within stalked structures called sporangia. When conditions become favourable again, spores germinate into biflagellated or amoeboid reproductive or swarm cells which unite to form diploid zygote. Zygote produces multinucleate plasmodium, each nucleus being diploid.

The plasmodial slime mold *Physarum polycephalum* is a model organism that has been used to study many fundamental biological processes, such as growth and differentiation, cytoplasmic streaming, and the function of cytoskeleton.



Water molds or Oomycetes

Oomycetes show close relations with the fungi and have a similar structure, but are now regarded as more ancient group. Their cell walls contain cellulose, not chitin. Their hyphae are aseptate (without cross walls). Oomycetes include a number of pathogenic organisms, including *Phytophthora infestans*, which have played infamous roles in human history.

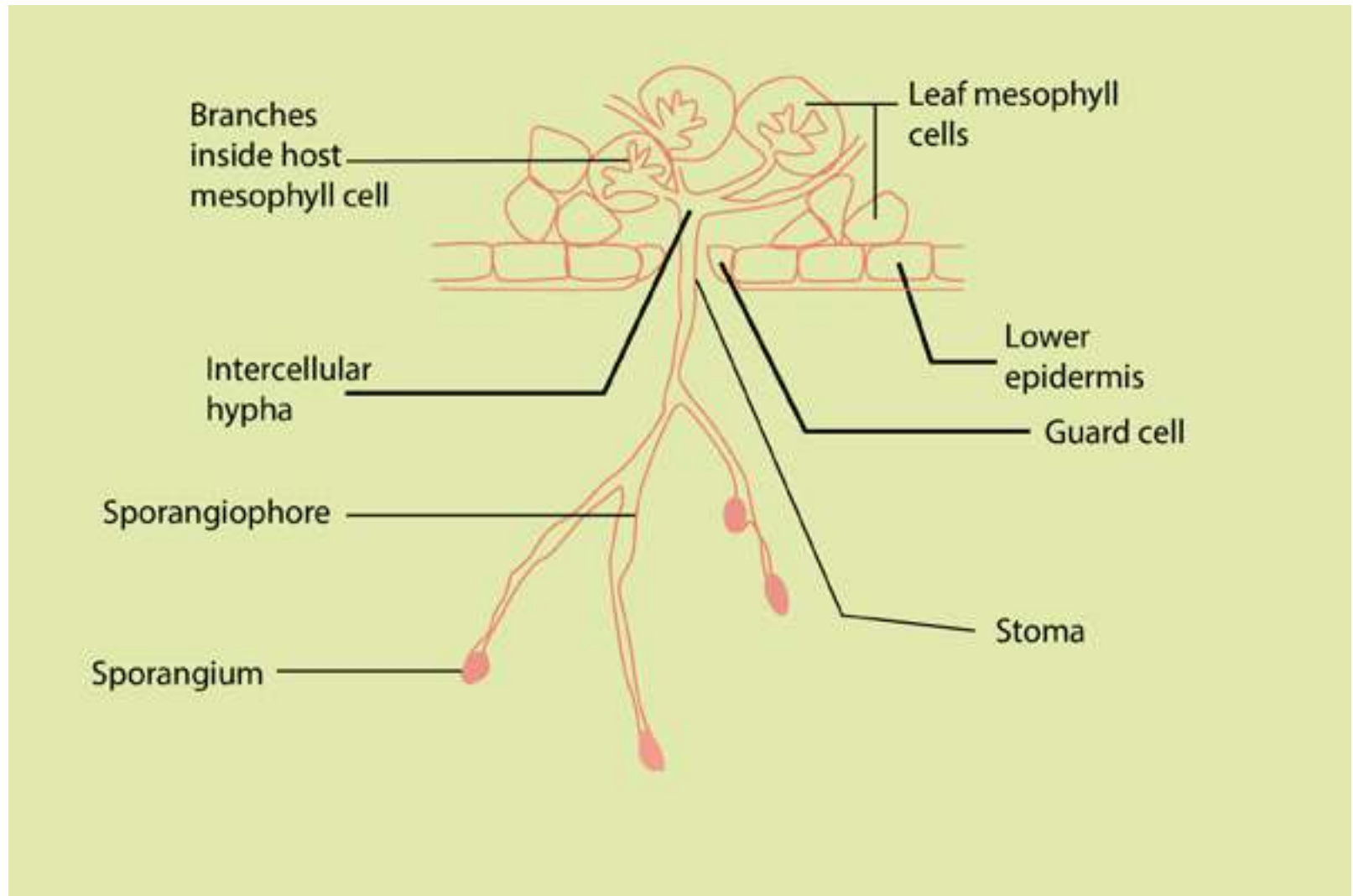

Fig. 7.15 *Phytophthora infestans* growing in a diseased potato leaf, with sporangiphores emerging from the underside of the leaf.

Phytophthora infestans was the cause of Irish potato famine of the 19th century. It causes a disease commonly known as late blight of potatoes. Because of several rainy, cool summers in Ireland in the 1840's, the water mold multiplied unchecked, causing potato tubers to rot in the fields. Since potatoes were the staple of Irish peasants' diet, many people (250,000 to more than 1 million) starved to death. The famine prompted a mass migration out of Ireland to such countries as the United States (Fig. 7.15).

EXERCISE**Q.1. Short Questions**

Write two characteristics of each of the following groups:

- | | |
|----------------|----------------------|
| (i) Protozoa | (ii) Dinoflagellates |
| (iii) Diatoms | (iv) Slime molds |
| (iv) Oomycetes | |

Q.2. Extensive question.

- (i) Discuss important features of protists. Why are protists so difficult to classify?
- (ii) What are the reasons for grouping simple eukaryotic organisms into a separate kingdom, protista?
- (iii) How are protists important to humans? What is their ecological importance?
- (iv) What are three major groups of protists?
- (vi) Discuss general characteristics of algae.
- (vii) Green algae are considered ancestral organisms of green land plants. Discuss.
- (viii) What features distinguish Oomycetes from fungi?
- (ix) Describe structure and reproduction of slime molds.

CHAPTER



Fungi

The Kingdom Of Recyclers

Animation 8.1: Kingdom Fungi
Source & Credit: unifyingprinciplesofbiology

Approximately 100,000 species of organisms called “**fungi**” are known and many more are estimated to be present. This group includes notorious pathogens such as disastrous rusts, smuts of wheat and corn, and molds found growing on important crops and foodstuff. Delicacies such as mushrooms, truffles and morels, and other organisms of commercial use such as *Penicillium* - the source of antibiotic penicillin, and the **yeasts** - used in bakeries and breweries are also members of this group. Ecological role of fungi as decomposers is paralleled only by bacteria.

Taxonomic status of fungi has changed from that of ‘a group of Plant kingdom’ to a separate kingdom “Fungi”. They resemble plants in some respects - have cell wall, lack centrioles and are non-motile. But fungi resemble more animals than plants. Unlike plants and like animals, fungi are heterotrophs, lack cellulose in their cell wall and contain **chitin** - the chemical found in external skeleton of **arthropods**. For this reason, some **mycologists** (scientists who study fungi) think that fungi and animals probably arose from a common ancestor. But fungi are different from animals in having cell wall, being absorptive heterotrophs and non-motile. So fungi are neither plants nor animals. Their DNA studies also confirm that they are different from all other organisms. They show a characteristic type of mitosis, called ‘**nuclear mitosis**’. During nuclear mitosis, nuclear envelope does not break; instead the mitotic spindle forms within the nucleus and the nuclear membrane constricts between the two clusters of daughter chromosomes. (In some fungi nuclear envelope dismantles late). Because fungi are distinct from plants, animals and protists in many ways, they are assigned to a separate kingdom ‘**Fungi**’.

THE BODY OF FUNGUS

The body of a fungus, called **mycelium**, consists of long, slender, branched tubular thread like filaments called the **hyphae** (singular **hypha**). Hyphae spread extensively over the surface of substratum. Chitin in their wall is more resistant to decay than are cellulose and **lignin** which make up plant cell wall. Hyphae may be septate or non-septate. **Septate** hyphae are divided by cross-walls called **septa** (singular septum) into individual cells containing one or more nuclei. Non-septate hyphae lack septa and are not divided into individual cells; instead these are in the form of an elongated multinucleated large cell. Such hyphae are called **coenocytic** hyphae, in which cytoplasm moves effectively, distributing the materials throughout. Septa of many septate fungi

have a pore through which cytoplasm flows from cell to cell, carrying the materials to growing tips and enabling the hyphae to grow rapidly when food and water are abundant and temperature is favourable. All parts of fungus growing through the substrate are metabolically active. Extensive spreading system of hypae provides enormous surface area for absorption.

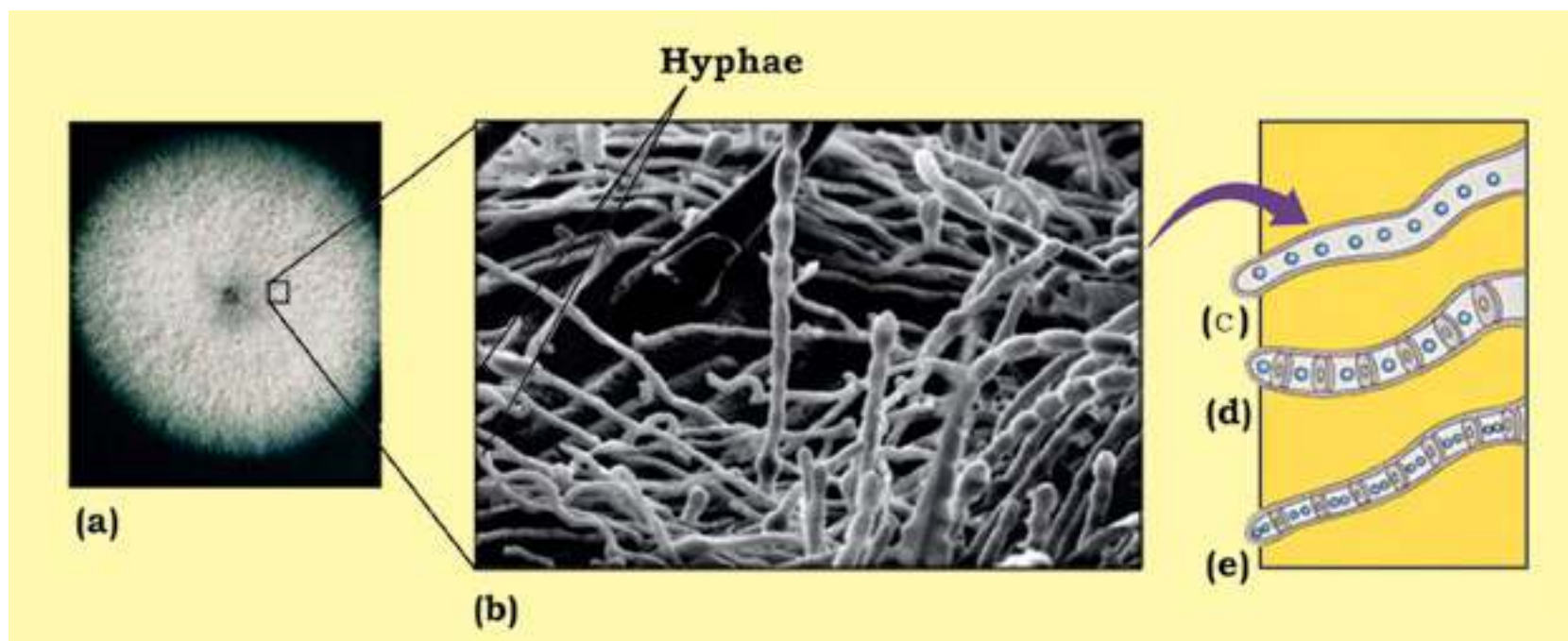

Fig 8.1 The fungus body plan : (a) Fungus mycelium growing on agar plate (b) Hyphae of mycelium (c) A coenocytic hypha (d) A septate hypha with porous septa and monokaryotic cells (e) A septate hypha with dikaryotic cell.

Hyphae may be packed together and organized to form complex reproductive structures such as mushrooms, puff balls, morels etc. which can expand rapidly. Yeast are non-hyphal unicellular fungi.

All fungal nuclei are **haploid** except for transient **diploid zygote** that forms during sexual reproduction.

A single mycelium may produce up to a kilometer of new hyphae in only one day. A circular clone of *Armillaria*, a pathogenic fungus afflicting conifers, growing out from a central focus, has been measured up to 15 hectares (1 hectare = 10000 m²). Could it be the world's largest organism?

NUTRITION IN FUNGI

All fungi lack chlorophyll and are heterotrophs (obtaining carbon and energy from organic matter). They obtain their food by direct absorption from the immediate environment and are thus **absorptive heterotrophs**. Most fungi are **saprotrophs** (or **saprobies**), **decomposers** that obtain their food (energy, carbon and nitrogen) directly from dead organic matter. They secrete out digestive **enzymes** which digest dead organic matter, and the organic molecules thus produced

are absorbed back into the fungus. Saprobic fungi anchor to the substrate by modified hyphae, the **rhizoids**. Fungi are the principal decomposers of cellulose and lignin, the main components of plant cell walls (most bacteria cannot break them). Extensive system of fast growing hyphae provides enormous surface for absorptive mode of nutrition. Saprobic fungi, alongwith bacteria, are the major decomposers of the biosphere, contributing to the recycling of the elements (C, N, P, O, H etc) used by living things.

Some fungi are **parasites**, some are even **predators**, and still others are **mutualists**. **Parasitic** fungi absorb nutrients directly from the living host cytoplasm with the help of special hyphal tips called **haustoria**. They may be obligate or facultative. Obligate parasites can grow only on their living host and cannot be grown on available defined growth culture medium. Various **mildews** and most rust species are obligate parasites. **Facultative parasites** can grow parasitically on their host as well as by themselves on artificial growth media.

Some fungi are active **predators**. The oyster mushroom (*Pleurotus ostreatus*) is an omnivorous (predatory) fungus. It paralyzes the nematodes (that feed on this fungus), penetrates them, and absorbs their nutritional contents, primarily to fulfil its nitrogen requirements. It fulfills its glucose requirements by breaking the wood. Some species of *Arthrobotrys* trap soil nematodes by forming **constricting ring**, their hyphae invade and digest the unlucky victim. Other predators have other adaptations, such as secretion of sticky substances.

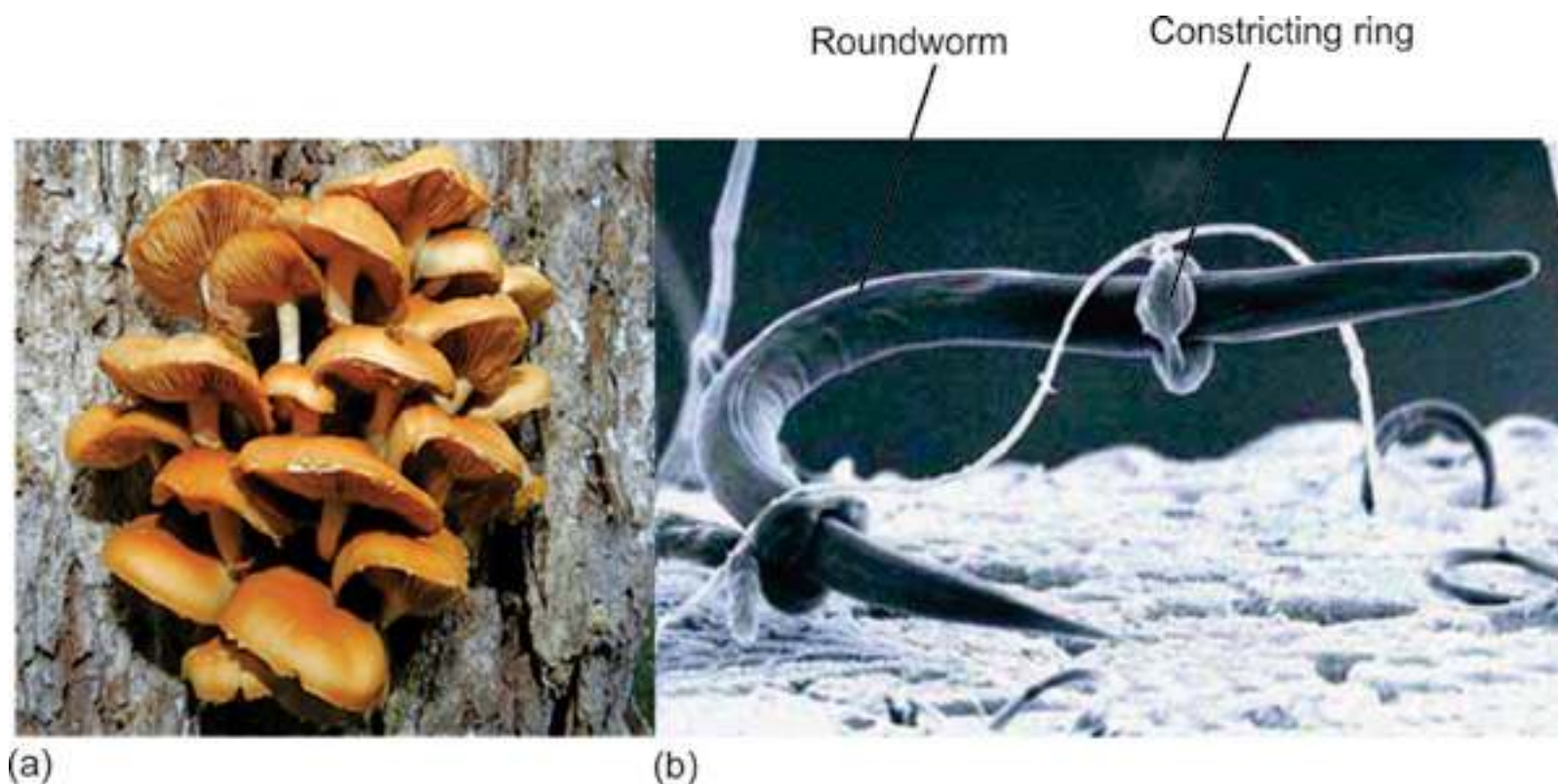
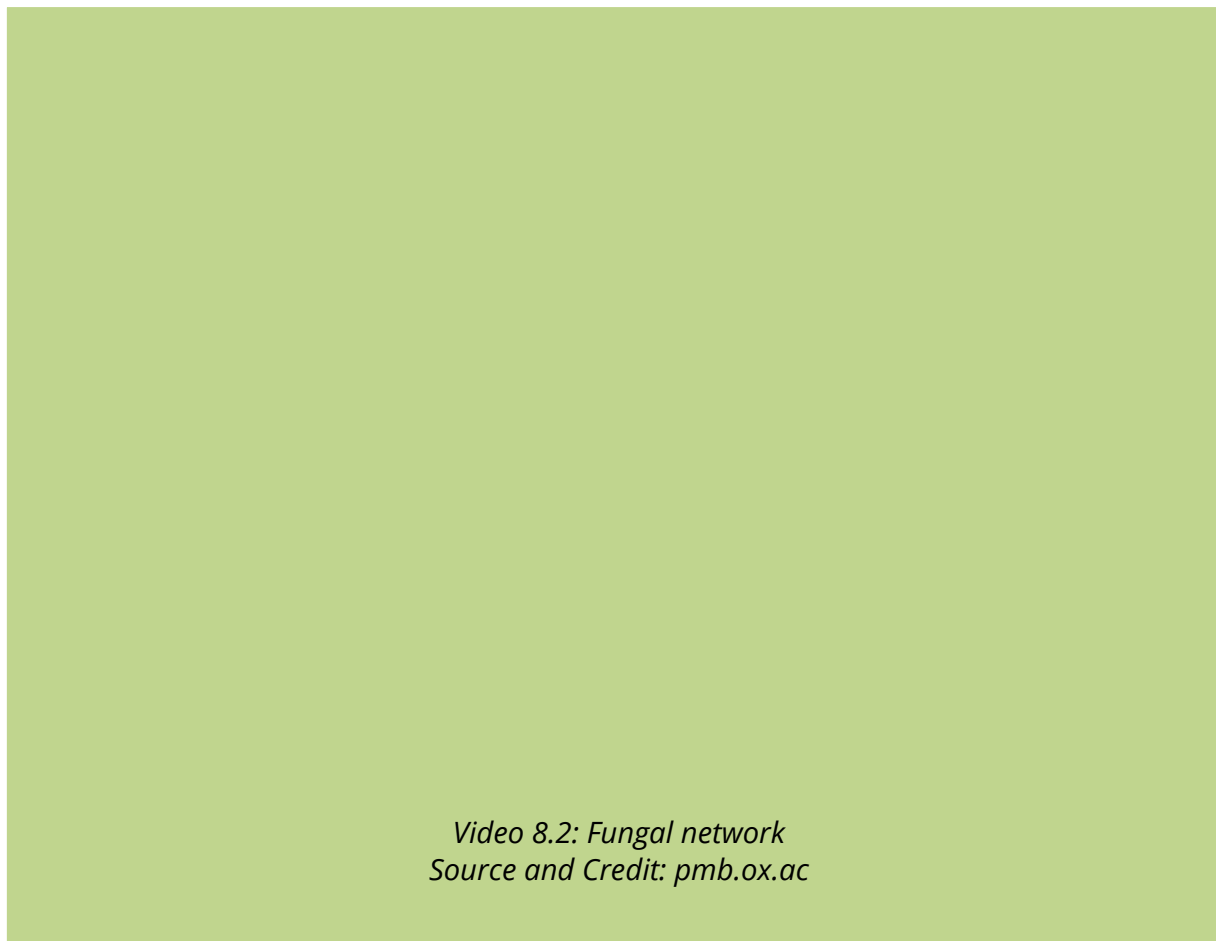

Fig 8.2 Carnivorous fungi (a) The oyster mushroom decomposes wood, and also uses nematodes as a source of nitrogen (b) A nematode is trapped in constricting ring of a soil-dwelling carnivorous fungus (*Arthrobotrys* sp.).

Fungi form two key mutualistic symbiotic associations (associations of benefit to both partners). These are **lichens** and **mycorrhizae**.

Lichens are mutualistic symbiotic associations between certain fungi (mostly Ascomycetes and imperfect fungi, and few Basidiomycetes - about 20 out of 15000 species of lichens) and certain photoautotrophs-either green algae or a cyanobacterium, or some times both. Most of the visible part of lichen consists of fungus, and algal components are present within the hyphae (Fig 8.3). Fungus protects the algal partner from strong light and desiccation and itself gets food through the courtesy of alga.

Lichens can grow at such places where neither of the components alone can, even at harsh places such as bare rocks etc. Lichens vary in colour, shape, overall appearance, growth form (Fig 8.3). They are ecologically very important as bioindicators of air pollution.



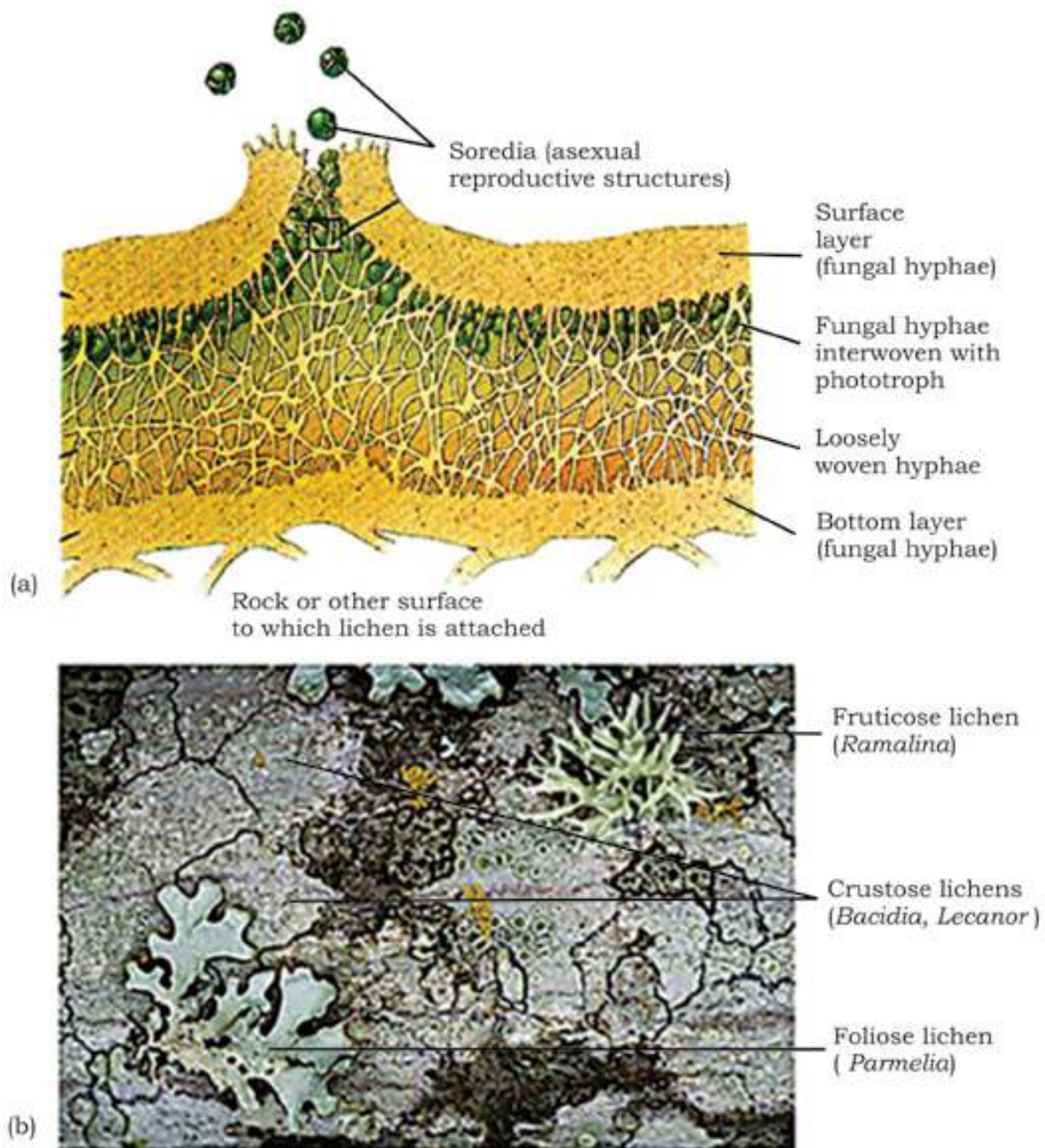

Fig 8.3 Lichens (a) Cross section of a typical lichen showing different layers, (b) Different types of lichens varying in size, colour and appearance. Three growth forms - crustose grow tightly attached to rocks, tree trunks etc; foliose are leaf-like, fruticose are branching.

Mycorrhizae are mutualistic association between certain fungi and roots of vascular plants (about 95% of all kinds of vascular plants). The fungal hyphae dramatically increase the amount of soil contact and total surface area for absorption and help in the direct absorption of phosphorus, zinc, copper and other nutrients from the soil into the roots. Such plants show better growth than those without this association. The plant, on the other hand, supplies organic carbon to fungal hyphae.

There are two main types of mycorrhizae (Fig 8.4): **endomycorrhizae**, in which the fungal hyphae penetrate the outer cells of the plant root, forming coils, swellings, and minute branches, and also extend out into surrounding soil; and **ectomycorrhizae**, in which the hyphae surround and extend between the cells but do not penetrate the cell walls of the roots. These are mostly formed with pines, firs etc. However, the mycelium extends far out into the soil in both kinds of mycorrhizae.

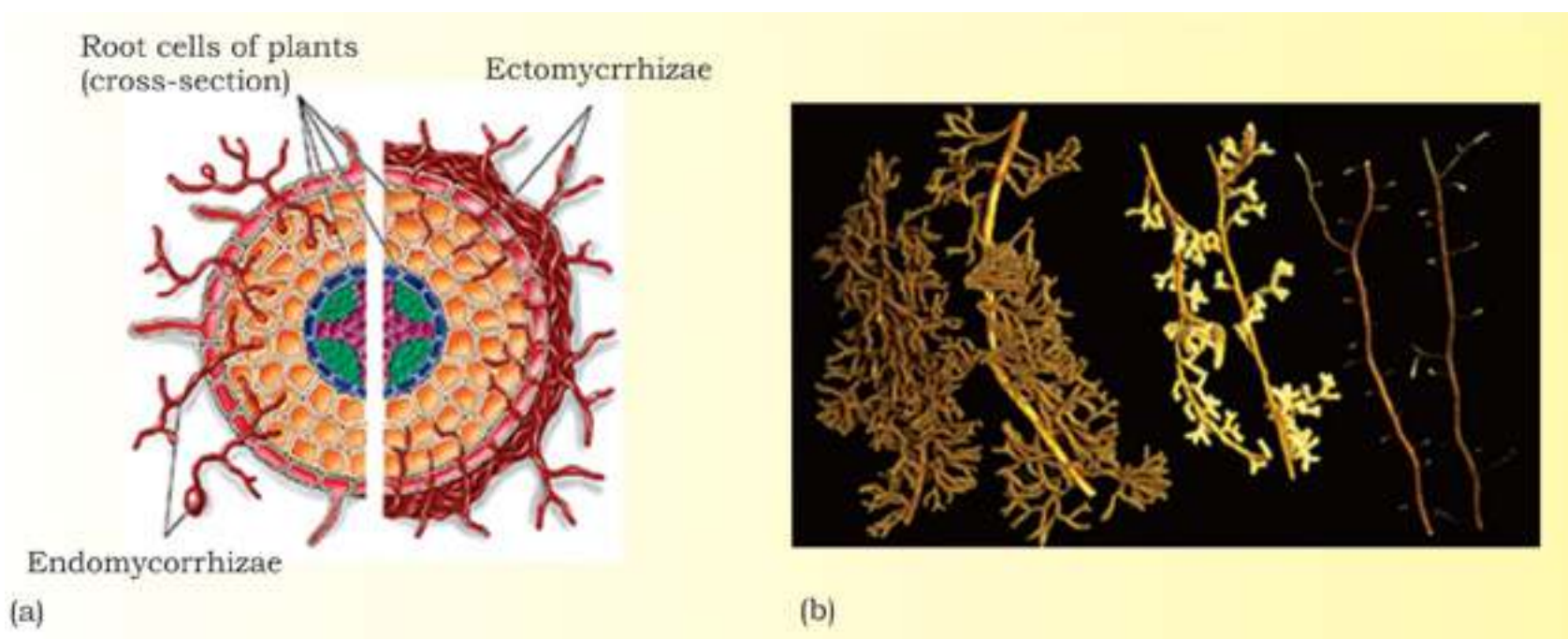

Fig 8.4 Endomycorrhizae and ectomycorrhizae. (a) In endomycorrhiza (left side of figure), fungal hyphae penetrate and branch out in a root cells. In ectomycorrhiza (right side of figure), fungal hyphae simply grow around but do not penetrate the root cell (b) Ectomycorrhizae on roots of pines.

Fungi grow best in moist habitats, but are found wherever organic matter is present. They survive dry conditions in some resting stage or by producing resistant spores. They can also tolerate a wide range of pH from 2 - 9, a wide temperature range, and high osmotic pressure such as in concentrated salt/sugar solutions as in jelly, jam etc. These features also help them in their survival on land. Fungi store surplus food usually as lipid droplets or glycogen in the mycelium.

REPRODUCTION

Most fungi can reproduce asexually as well as sexually (except imperfect fungi in which sexual reproduction has not been observed).

Asexual reproduction

Asexual reproduction takes place by spores, conidia, fragmentation, and budding. **Spores** are produced inside the reproductive structures called **sporangia**, which are cut off from the hyphae by complete septa. Spores may be produced by sexual or asexual process, are haploid, non-motile and not needing water for their dispersal, are small, produced in very large number and dispersed by wind to great distances and cause wide distribution of many kinds of fungi, including many plant pathogens. When spores land in a suitable place, they germinate, giving rise to new fungal hyphae. Spores may also be dispersed by insects and other small animals and by rain splashes. Spores are a common means of reproduction in fungi.

Conidia (singular conidium) are non-motile, asexual spores which are cut off at the end of modified hyphae called **conidiophores**, and not inside the sporangia, usually in chains or clusters. These may be produced in a very large number, can survive for weeks and cause rapid colonization of new food.

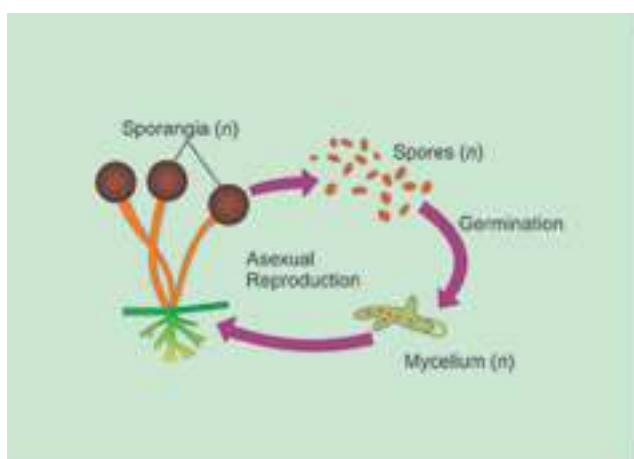

Fig. 8.5 Spores are released from sporangia and germinate to produce new hyphae.

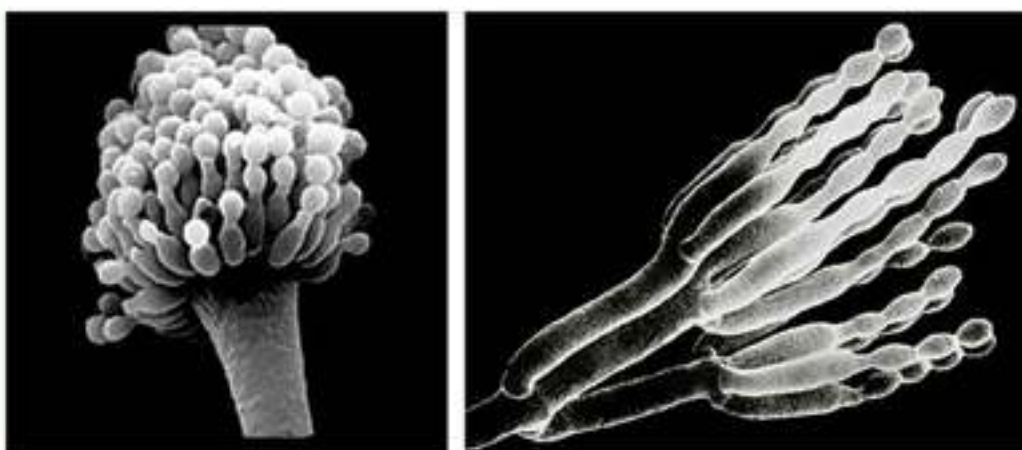

Fig. 8.6 Conidia cut off at the tip of conidiophores in clusters chains

Fragmentation is simple breaking of mycelium of some hyphal fungi, each broken fragment giving rise to a new mycelium.

Unicellular yeasts reproduce by **budding** (an asymmetric division in which tiny outgrowth or bud is produced which may separate and grow (Fig 8.7), or by simple, relatively equal cell division.

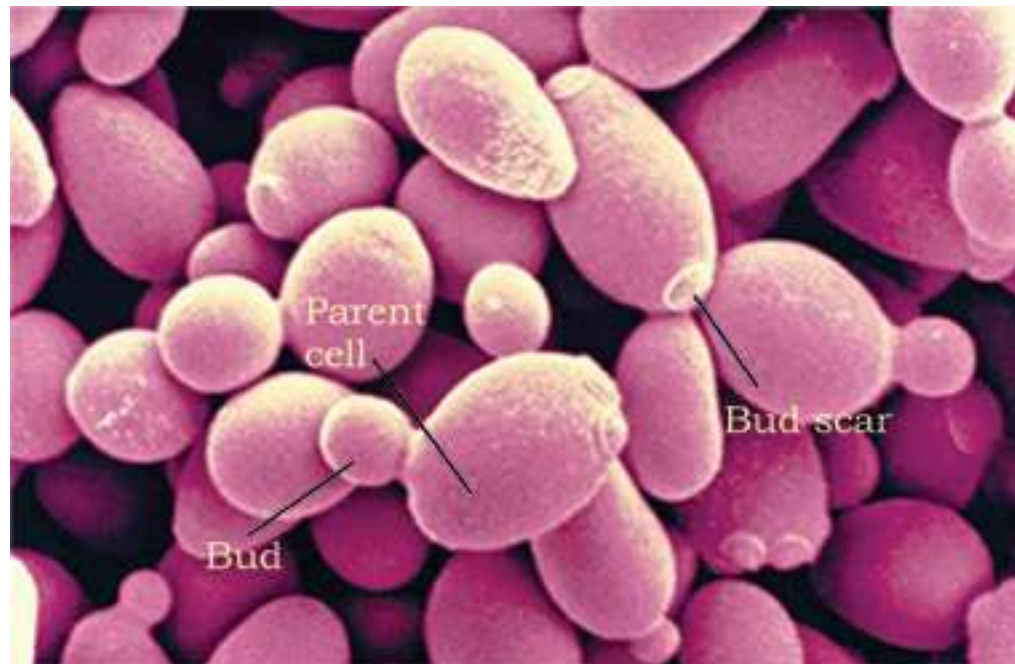

Fig. 8.7 Micrograph shows yeast (*Saccharomyces cerevisiae*) in various stages of budding.

Sexual Reproduction

Details of sexual reproduction vary in different groups of fungi but fusion of haploid nuclei and meiosis are common to all. When fungi reproduce sexually, hyphae of two genetically different but compatible mating types come together, their cytoplasm fuse followed by nuclear fusion. In two of the three main groups of fungi (Basidiomycetes, Ascomycetes), fusion of nuclei (**karyogamy**) does not take place immediately after the fusion of cytoplasm (**plasmogamy**); instead the two genetic types of **haploid** nuclei from two individuals may coexist and divide in the same hyphae for most of the life of the fungus. Such a fungal hypha/cell having 2 nuclei of different genetic types is called **dikaryotic** (also **heterokaryotic**) hypha/cell (Fig. 8.1).

Different groups of fungi produce different types of haploid sexual spores, such as **basidiospores** and **ascospores**, subsequent upon meiosis in zygote. These spores may be produced by their characteristic structure/fruitleting bodies such as **basidia/basidiocarps** and **asci/ascocarps**.

CLASSIFICATION OF FUNGI

Classification of fungi into four main groups is based primarily on the type of their sexual reproductive structures and methods of reproduction. However, these groups also differ in the type of hyphae and some other characters (Table 8.1).

Table 8.1 Classification of Fungi

Phylum (group)	Typical examples	Sexual reproduction	Asexual reproduction	Hyphae
Zygomycota (Zygomycetes)	<i>Rhizopus</i> , (Black bread mold) <i>Pilobolus</i> (spitting fungus)	Zygospores	Non-motile spores form in sporangia	Nonseptate, multi nucleate
Ascomycota (Ascomycetes or sac - fungi)	Yeasts, morels, truffles, powdery mildews, molds	Ascospores inside sac-like asci	Conidia cut off from tips of conidiophores	Septate, lengthy dikaryotic phase.
Basidiomycota (Basidiomycetes or club-fungi)	Mushrooms, rusts, smuts, puffballs, bracket fungi	Basidiospores borne on club shaped basidia	Uncommon	Septate, lengthy dikaryotic phase
Deuteromycota (Deuteromycetes/ Imperfect fungi)	<i>Aspergillus</i> , <i>Penicillium</i> , <i>Altemaria</i>	Sexual phase has not been observed	Conidia	Varied

Zygomycota (Zygomycetes or Conjugating Fungi)

During their sexual reproduction, zygote formed directly by the fusion of hyphae forms temporary, dormant, thick walled resistant structure called zygospore, hence the name Zygomycetes. Meiosis takes place when zygospore germinates and haploid spores are produced. Spores on germination produce new mycelium. Asexual reproduction by spores is common. Hyphae are coenocytic.

Example: *Rhizopus*, found growing on spoiling moist bread, fruit etc.

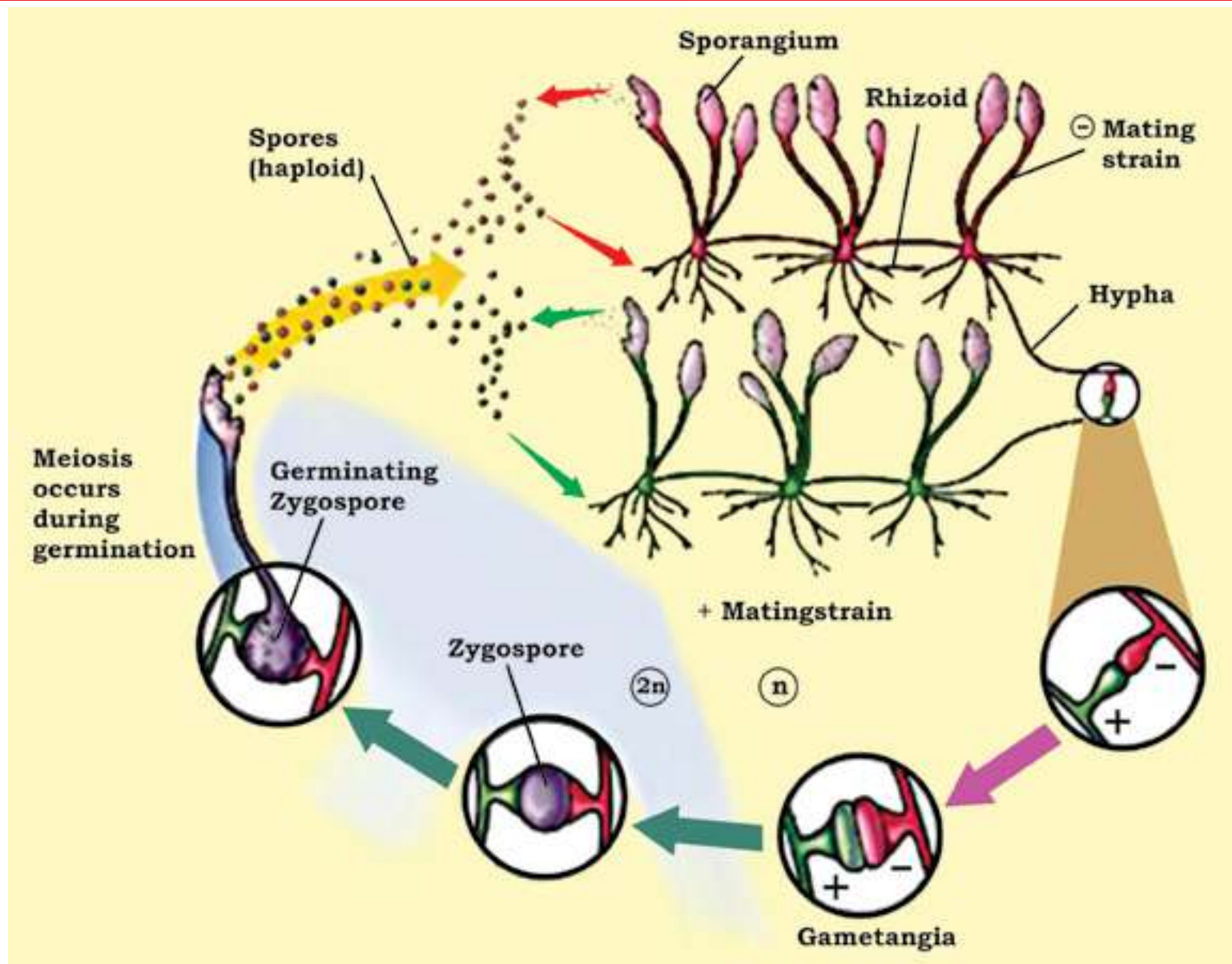

Fig. 8.8 Life cycle, of *Rhizopus* (black bread mold), a Zygomycete. Zygote formed by fusion, of gametangia directly develops into a resting zygospore.

Ascomycota (Ascomycetes or Sac - Fungi)

It is the largest group of fungi, including over 60,000 species, 50% or so occurring in lichens and some, such as morels, are mycorrhizal. Most are terrestrial, though some are marine or fresh water. The group shows diversity from unicellular yeasts to large cup fungi and morels. They produce haploid sexual spores called **ascospores** by meiosis inside their characteristic sac like structures called **asci** (sing.ascus). Meiosis follows nuclear fusion inside the ascus, commonly 8 ascospores are produced inside each ascus. Most sac-fungi have asci inside macroscopic fruiting bodies called **ascocarps**-the visible morels etc. Their hyphae are septate. They have lengthy dikaryotic phase that forms ascocarps. They reproduce asexually by conidia that are often dispersed by wind.

Yeasts are unicellular microscopic fungi, derived from all the three different groups of fungi but mostly Ascomycetes, and reproducing mostly asexually by budding (Fig. 8.7).

However yeasts reproduce sexually by forming asci/ascospores or basidia/basidiospores. They ferment carbohydrate (glucose) to ethanol and carbondioxide. Because of this feature and many other reasons, these are of great economic importance (see economic importance of fungi). *Saccharomyces cerevisiae* is the most commonly exploited yeast.

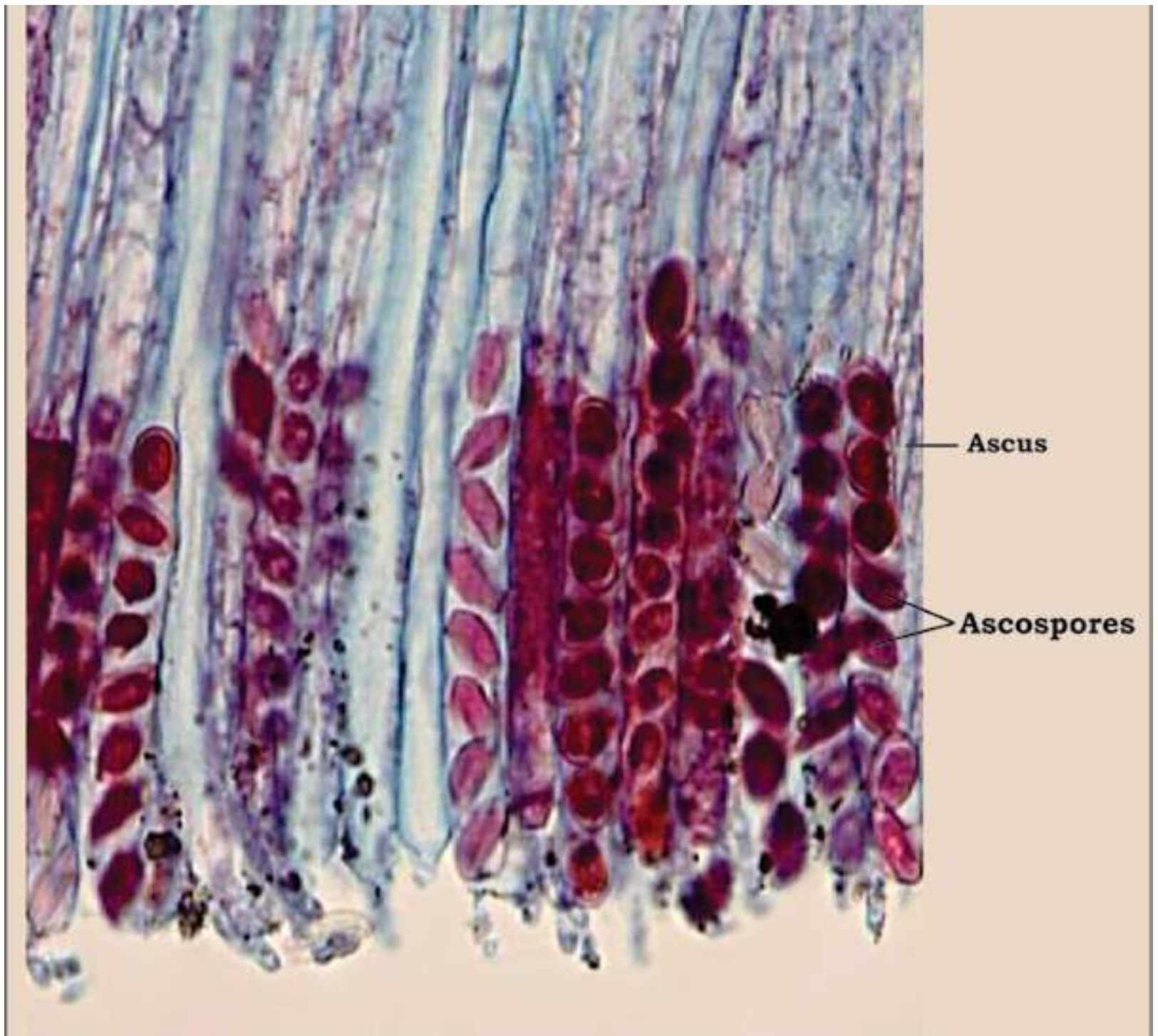

Fig. 8.9 Asci and Ascospores. Each ascus contains eight haploid ascospores

Basidiomycota (Basidiomycetes or Club - Fungi)

These are among the most familiar fungi; edible mushrooms, devastating plant pathogens rusts and smuts, puffballs, and bracket/shelf fungi are all club fungi. Basidiomycetes are named so for their characteristic, club-shaped (hence also called club fungi) sexual reproductive structure, the **basidium** (plural **basidia**). Nuclear fusion in the basidium is followed by meiosis.

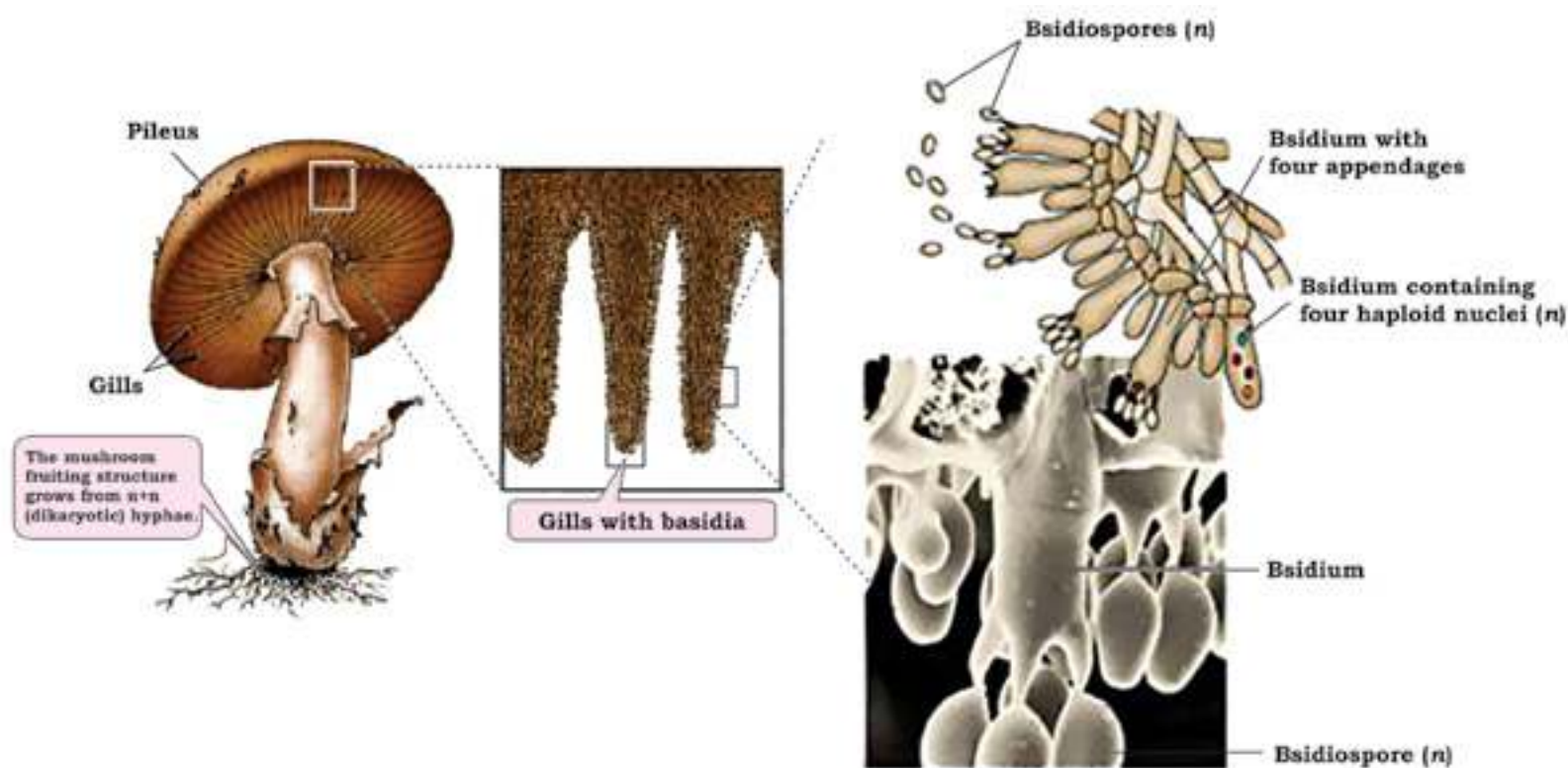

Fig. 8.10 Basidiomycetes. A mushroom's fruiting structures. The gills on underside of mushroom's cap are lined with basidia, on which basidiospores are produced.

Four haploid sexual spores, called the **basidiospores**, are born on, not inside, each basidium. During most part of their life cycle the hyphae are septate; the cells are uninucleate during one phase, and binucleate (dikaryotic) during the remaining, lengthy phase. Their characteristic fruiting bodies, or visible mushrooms, are formed entirely of dikaryotic mycelium. **Puccinia** species are most common rust fungi, and **Ustilago** species most common smut fungi.

Rusts are called so because of numerous rusty, orange-yellow coloured disease spots on their host surface (mostly stem, leaves), later revealing brick/rust-red spores of the fungus. **Smuts** are called so because of their black, dusty spore masses that resemble soot or smut; these spore masses replace the grain kernels such as those of wheat, corn etc. (Fig. 8.11, 8.15)

Spores (teliospores) of *Ustilago tritici* (loose smut of wheat) are carried by wind from infected wheat ears to healthy flowers, where they germinate. The resulting hyphae penetrate flower ovaries. Inside the ovary mycelium spreads and becomes dormant and remains so in the seed (grain). When such infected seeds are sown next season, the hyphae also grow within the growing plant and form smut spores inside the kernel, thus destroying them completely. The covering of the grain breaks exposing the black spores mass, that may be dispersed by wind (Fig. 8.11)

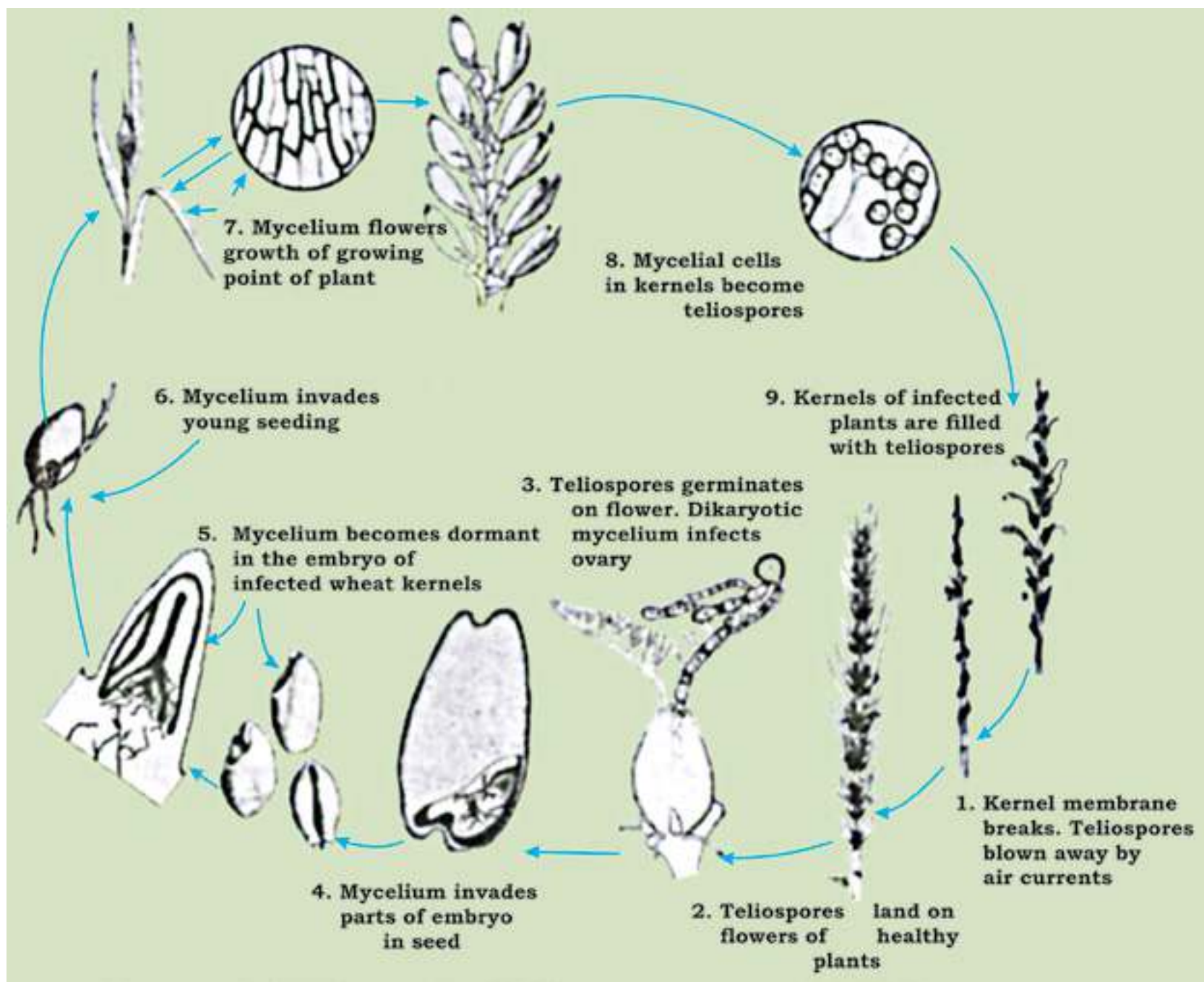

Fig. 8.11: Disease cycle of loose smut of wheat caused by a club - fungus (*Ustilago tritici*)

Deuteromycota (Deuteromycetes or Imperfect Fungi)

This heterogenous group includes all such fungi in which sexual phase has not been observed. Most of them are related to their sexually reproducing relatives of Ascomycetes; however some are related to other two phyla (Zygomycota, Basidiomycota) as well. If sexual structures are found on an imperfect fungus, it is then reassigned to the appropriate phylum. Biologists now can classify most imperfect fungi on the basis of DNA sequences, though sexual structures may not be found.

Penicillium (blue, green molds), *Aspergillus* (brown molds), *Alternaria*, *Fusarium*, *Helminthosporium* are some of the economically important genera of Deuteromycetes (see economic importance of fungi).

Penicillium sp. (blue, green molds) are wide spread saprotrophic species common on decaying fruit, bread etc. Its hyphae are septate. *Penicillium* reproduces asexually by means of naked spores called **conidia**. These are found in chains at the tips of special hyphae called **conidiophores**, which are branched. Brush-like arrangement of its conidia is characteristic of *Penicillium* (Fig. 8.12). These conidia give colour to the mycelial colony, which is circular. Mature conidia are easily and readily dispersed.

*Despite absence of sexual reproduction, imperfect fungi show special kind of genetic recombination, called **parasexuality**, in which portions of chromosomes of two nuclei lying in the same hypha are exchanged.*

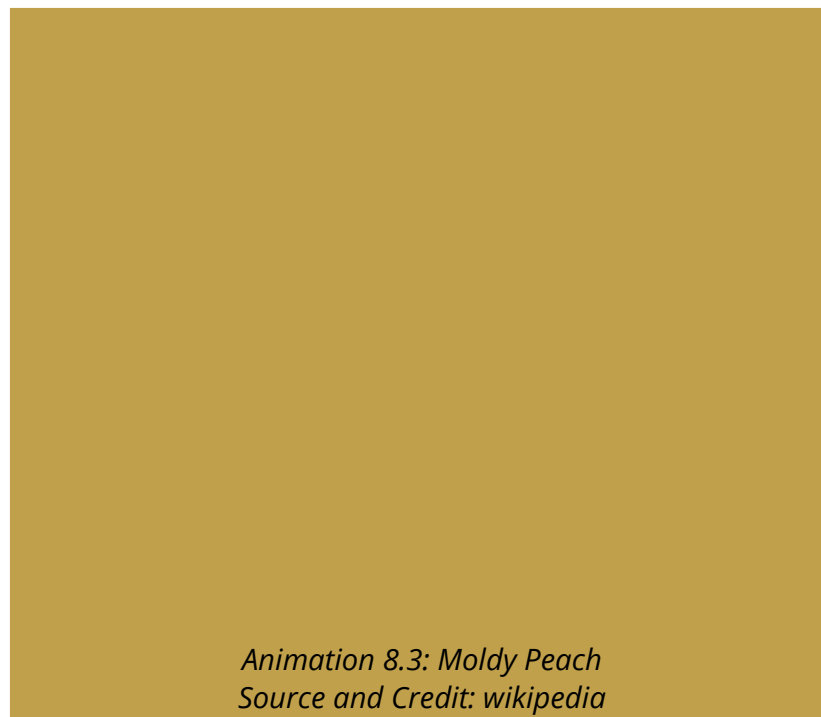

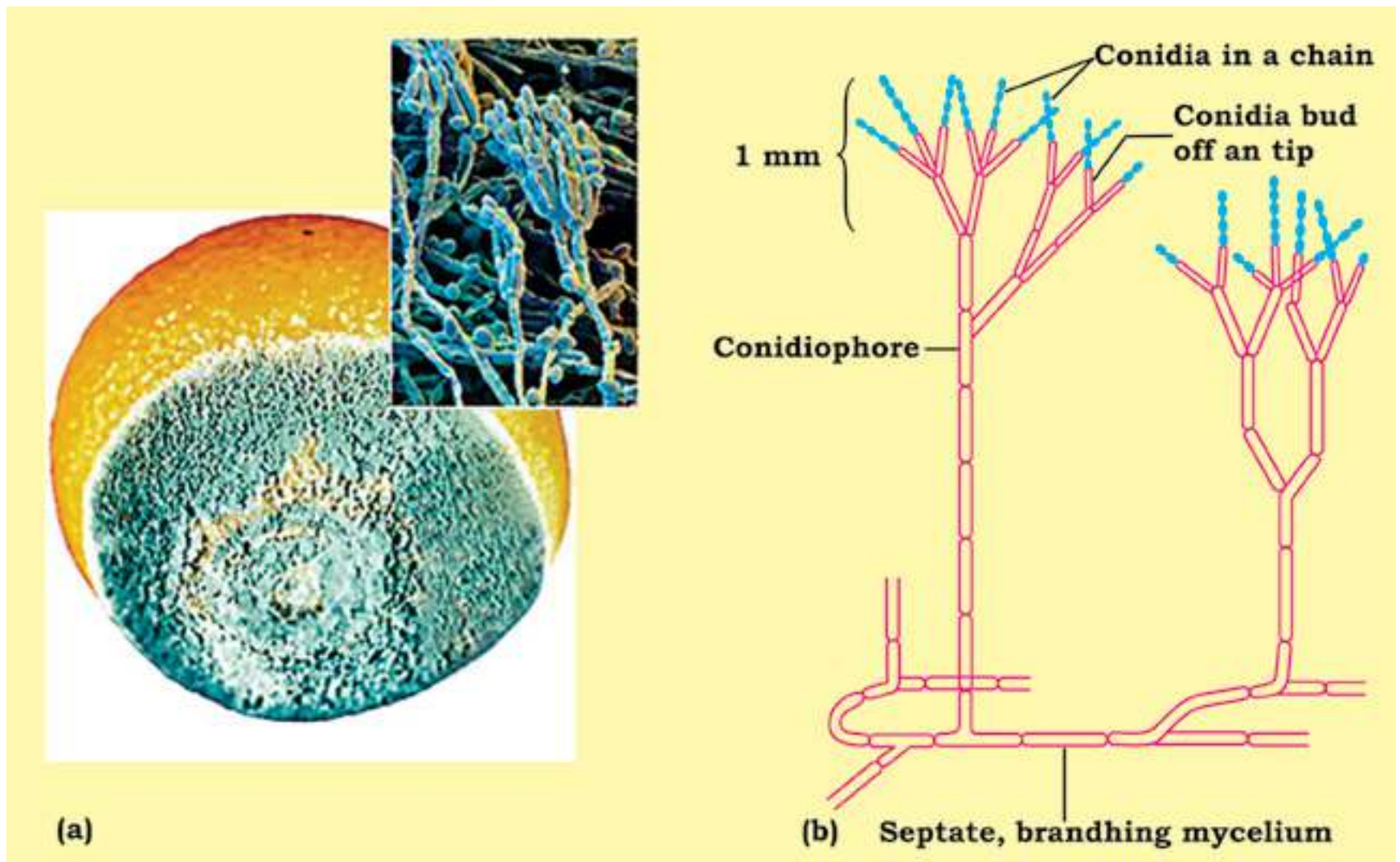

Fig. 8.12 *Penicillium* (a) A moldy orange; the blue mold is caused by saprobic species of *Penicillium*. (b) *Penicillium* showing asexual reproduction, characteristic brush-like arrangement of conidia.

LAND ADAPTATIONS OF FUNGI

Fungi; although grow best in moist habitats, are found wherever organic matter is present. They are a successful group of land organisms, and possess several features in their body and reproduction that adapt them to their habit and terrestrial mode of life.

Extensive system of fast-spreading hyphae penetrate the substrate and enormously increase the contact and surface area for absorption. Cytoplasmic flow throughout the hyphae is responsible for their rapid growth and spread. Chitin in their thickened hyphal wall is more resistant to decay than are cellulose and lignin found in plant cell wall. They can even break down the lignin (in addition to

cellulose) to obtain their nutrients. In saprobes, certain modified hyphae called **rhizoids** anchor the fungus to the substrate and also digest and then absorb the food.

They are very well adapted to live on land due to lack of flagellated cells, nonmotile spores and conidia efficient dispersal by wind, thick-walled zygote and other resistant structures. Hyphae may be modified in such a way as to enable them to reproduce themselves without dependence on external water.

Many fungi are more tolerant than are bacteria to damage in hyperosmotic surroundings. Many can tolerate temperature extremes - 5°C below freezing and 50°C or more. Now you can tell why molds (e.g. *Penicillium*) can grow on oranges and jelly kept in a refrigerator, while generally bacteria cannot.

IMPORTANCE OF FUNGI

Ecological Importance

Fungi have great ecological impact. They are very important as decomposers and symbionts. Fungi, along with saprobic bacteria, play vital role in the recycling of inorganic nutrients in the ecosystem. Without their activity all the essential nutrients would soon become locked up in the mounds of dead animals, plants, would be unavailable for use by organisms, and life would cease. Mycorrhizal fungi improve the growth of plants with which they are associated. 95% of all kinds of vascular plants have this association.

Lichens growing on rocks break them, setting stage for other organisms during the course of ecological succession. Lichens are very good bioindicators of air quality as they are very sensitive to pollution. Some fungi are also used for bioremediation (degrading/removing environmental poisons/pollutants by organisms).

Commercial Importance

Fungi cause economic gains as well as losses.

Economic gains due to fungi

1. Certain fungi are edible. About 200 species of mushrooms (e.g. *Agaricus* sp), morels (e.g. *Morchella esculenta*), truffles (underground fruiting bodies of some



(a)



(b)

Fig. 8.13 Edible fungi (a) A common morel (*Morchella esculenta*). (b) The truffles (*Tuber* species) are underground fruiting bodies that people find with the help of trained dogs or pigs.

Ascomycetes, e.g. *Tuber* sp) are common edible fungi. Beware of poisonous mushrooms called the **toadstools**, such as death cap/death angel (*Amanita*) and jack-O' lantern mushroom (Fig. 8.14).



(a)



(b)

Fig. 8.14 a: Poisonous mushroom Jack-O' lantern (*Omphalotus olearius*) whose gills glow in the dark, b: *Amanita*, another common poisonous mushroom.

Reindeer moss (a lichen, not a moss) is used as food for reindeers and some other large animals in arctic/subarctic/boreal regions.

2. Certain fungi are used in food industry. Because of their fermenting ability, yeasts (*Saccharomyces cerevisiae*) are used in the production of bread and liquor. *Penicillium* species are used for giving flavour, aroma and characteristic colour to some cheese. Some species of *Aspergillus* are used for

fermenting/producing soya sauce and soya paste from soya bean. Citric acid is also obtained from some *Aspergillus* species.

3. Some fungi are source of antibiotics and some other drugs. *Penicillin*, first antibiotic to be ever discovered (by A. Fleming-1928) is obtained from *Penicillium notatum*. Lovastatin is used for lowering blood cholesterol; cyclosporine obtained from a soil fungus is used in organ transplantation for preventing transplant rejection; and ergotamine to relieve one kind of headache migraine. Griseofulvin is used to inhibit fungal growth.

4. Some natural dyes obtained from lichens are used in textile industry.

5. Yeasts are heavily used in genetic/molecular biological research because of their rapid generation and rapidly increasing pool of genetic and biochemical information. Yeast were the first eukaryotes to be used by genetic engineers. In 1983, a functional artificial chromosome was made in *Saccharomyces cerevisiae*. The same yeast was the first eukaryote whose genomic sequence was completely studied in 1996. Yeasts are also being investigated for production of some hormones. Pink bread mold *Neurospora* has also been used for genetic research.

Economic losses due to Fungi

1. Fungi are responsible for many serious plant diseases because they produce several enzymes that can breakdown cellulose, lignin and even cutin. All plants are susceptible to them. Extensive damages due to rusts and smut diseases of wheat, corn (Fig. 8.15) and rice prompted mass displacement, and starvation to death of many people.

Powdery mildews (on grapes, rose, wheat etc), **ergot of rye**, **red rot of sugar cane**, **Potato wilt**, **cotton root rot**, **apple scab**, and **brown rot** of peaches, plums, apricots and cherries are some other common plant diseases caused by fungi.

2. Fungi also cause certain animal diseases. **Ringworm** and **athlete's foot** are superficial fungal infections caused by certain imperfect fungi. *Candida albicans*, a yeast, causes oral and vaginal thrush (*Candidiasis* or *candidosis*). **Histoplasmosis** is a serious infection of lungs caused by inhaling spores of a fungus which is common in soil contaminated with bird's feces. If infection spreads into blood stream and then to other organs (which is very occasional), it can be serious and even fatal. *Aspergillus fumigatus* causes **aspergillosis**, but only in persons with defective immune system such as AIDS, and may cause death. Some strains of *Aspergillus* produce one of the most carcinogenic

(cancer-causing) mycotoxins (toxins produced by fungi), called **aflatoxins**. *Aspergillus* contaminates improperly stored grains such as peanuts and corn etc. Milk, eggs and meat may also have small traces of aflatoxins. Any moldy human food or animal forage product should be discarded. **Ergotism** is caused by eating bread made from purple ergot-contaminated rye flour. The poisonous material in the ergot causes nervous spasm, convulsion, Psychotic delusion and even gangrene.

3. Saprobic fungi are not only useful recyclers but also cause incalculable damage to food, wood, fiber, and leather by decomposing them. 15-50% of world's fruit is lost each year due to fungal attack. Wood-rotting fungi destroy not only living trees but also structural timber. Bracket/ shelf fungi (Fig. 8.16) cause lot of damage to stored cut lumber as well as stands of timber of living trees.

A pink yeast (*Rhodotorula*) on shower curtains and other moist surfaces.

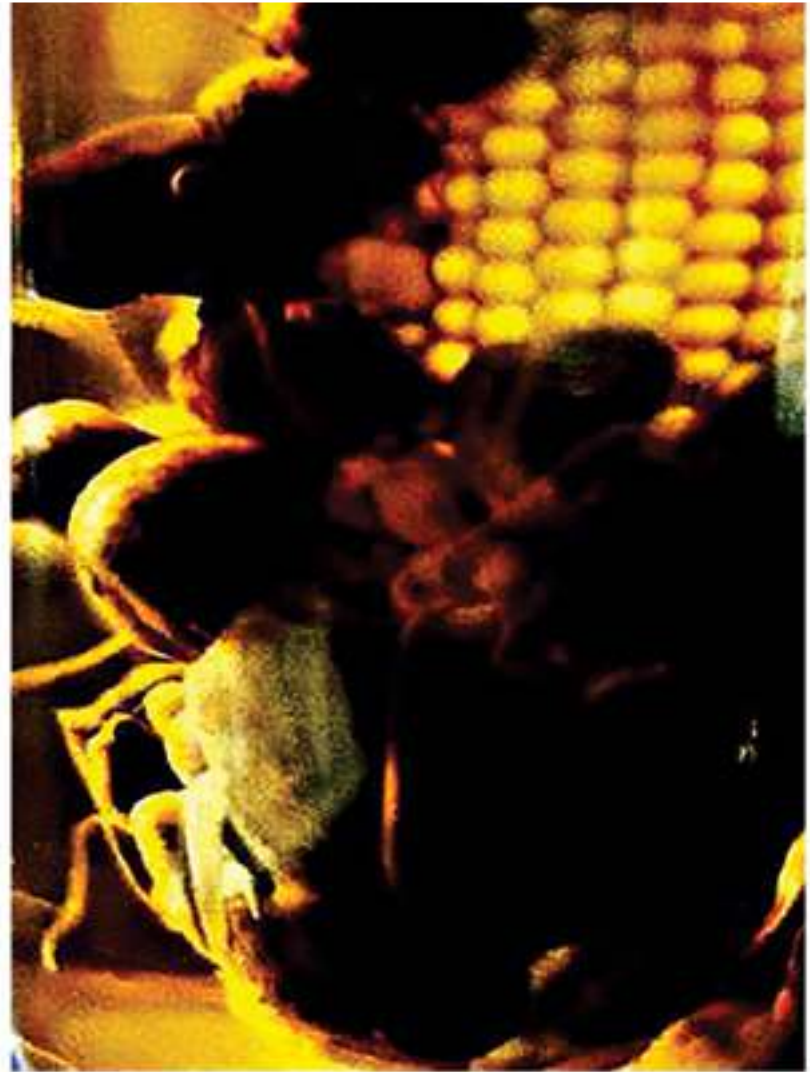

Fig. 8.15 Plant Pathogenic fungus. Corn smut on an ear of sweet corn is caused by *Ustilago maydis*

Video 8.4: Mushrooms Fungi
Source and Credit: rebloggy



Fig. 8.16 This shelf fungus is parasitizing a tree. These are important decomposers of wood

EXERCISE**Q.1. Short questions**

- (i) What is a hypha? What is the advantage of having incomplete septa?
- (ii) What is the composition of fungal cell wall and how is this composition advantageous to fungi?
- (iii) To which phyla do yeasts belong? How do they differ from other fungi?
- (iv) Name sexual and asexual spores of Ascomycetes.
- (v) What are mycorrhizae?
- (vi) By what means can individuals in imperfect fungi be classified?
- (vii) Give a single characteristic that differentiates Zygomycota from Basidiomycota.
- (viii) Why is green mold more likely to contaminate an orange kept in a refrigerator than are bacteria?
- (ix) What is a fungus?
- (x) State two parallel characteristics of Ascomycetes and Basidiomycetes.

Q.2. Extensive questions

- (i) Discuss taxonomic status of fungi.
- (ii) Summarise differentiating/distinguishing characteristics of four main groups of Fungi, and give two common examples of each group.
- (iii) State various features of fungi that adapt them to terrestrial mode of life.
- (iv) What is ecological importance of saprotrophic fungi, of lichens and mycorrhizae?

- (v) Same enzymes of fungi are useful on one hand and harmful on other. Discuss.
- (vi) Name any four important fungal diseases of plants and four fungal diseases of humans, and briefly describe any one of the plant diseases and any one of the diseases of humans.
- (vii) Describe, giving examples, different ways in which fungi are useful to humans.
- (viii) Differentiate between the members of each of the following pairs.
- | | | | |
|-----|--|-----|----------------|
| (a) | Spore/Conidium | (b) | Ascus/Basidium |
| (b) | Dikaryotic/Diploid | (c) | Ascocarp/Ascus |
| (c) | Obligate parasite/Facultative parasite | | |
| (d) | Endomycorrhizae/Ectomycorrhizae | | |
| (e) | Plasmogamy/Karyogamy | | |

CHAPTER

9

Kingdom Plantae

Animation 9.1: Kingdom Plantae
Source & Credit: storify

During the past few decades biologists have been trying to classify living organisms into various groups which could logically reflect their similarities and dissimilarities at various levels. The groups were supposed to foreshadow the natural relationships among living organisms and their mode of origin. Such a system of classification is called **Phylogenetic System of Classification**.

Kingdom Plantae mainly includes eukaryotic, autotrophic, multicellular, non motile organisms which develop from embryos. Plant cells have cell wall outer to cell membrane which is composed of cellulose. There are about 360,000 known species of plants.

CLASSIFICATION OF PLANTAE

For the sake of convenience organisms included in Plantae can be divided into two broad categories viz. non vascular (**Bryophyta**) and vascular (**Tracheophyta**) plants. Although this grouping is not according to any specific system of classification but it does reflect similarities and dissimilarities among various groups of plants. Each category (division) is divided into Sub-divisions, Classes, Sub-classes and other taxonomic ranks. Detailed discussion of classification of Plantae will be beyond the scope of this book. Following is a brief outline of classification of Plantae.

Table 9.1: An outline of Classification of Plantae

Division : Bryophyta - (Non-Vascular Plants)		Common Name
Sub Division	Hepaticopsida	Liverworts
Sub Division	Musci (Bryopsida)	Mosses
Sub Division	Anthoceropsida	Hornworts
Division : Tracheophyta - (Vascular Plants)		
Sub Division	Psilopsida	Whisk ferns
Sub Division	Lycopsida	Club mosses
Sub Division	Sphenopsida	Horse tails
Sub Division	Pteropsida	Fern Seed plants
Class	Filicineae	Ferns
Class	Gymnospermae	Naked-seeded plants
Class	Angiospermae	Flowering Plants

DIVISION BRYOPHYTA

The first plants to colonize land were the bryophytes. They are generally thought to have evolved from green algae.

The Bryophytes are poorly adapted to live on land and are mainly confined to damp shady places (Fig. 9.1).

These plants are devoid of specialized conducting (xylem and phloem) and strengthening tissues. Only the process of diffusion and osmosis helps in the transportation of water and minerals as well as in transportation of prepared food and other substances. The plant body is with a proper cuticle, or has a very thin one. The water is absorbed by the general surface of the plant. The bryophytes are said to be the **amphibians of the plant world** because they cannot live away from water. They need water for reproduction (Fig. 9.2).

The bryophytes are non-vascular flowerless plants. These plants show a regular **alternation of heteromorphic (morphologically different) generations**. They have a dominant independent free living **gametophyte**. This may be thalloid as in many liverworts or is differentiated into structures resembling to stem, leaves and absorbing and anchoring organs, **rhizoids**, as in mosses and some liverworts. The gametophyte produces a **sporophyte**, which is a less conspicuous generation, partially or totally dependent upon the gametophyte for its nutrition.

The sporophyte generally consists of foot, seta and capsule. The sporophyte is diploid ($2n$) which produces in sporangia one kind of haploid spores (i.e. it is **homosporous**) by meiosis.



Fig 9.1. A moss bug, lacking rigid supporting tissue, bryophytes are low-profile plants they are most common in damp habitats



Fig 9.2 Mosses often grow at wet places as seen here in a small water fall

The spores germinate and give rise to gametophyte which is also haploid. Multicellular male and female sex organs i.e. **antheridia** and **archegonia** respectively, are born on gametophyte either on same or different plants. These sex organs are multicellular and protected by a sterile covering of cells (Fig. 9.3).

Gametes are produced by mitosis. Male gametes produced within antheridia are called **antherozoids**; antherozoids are motile and always produced in large number. Female gametes formed within archegonia are termed as **eggs**. A single egg is formed in each archegonium. Fertilization takes place in water. Antherozoids (n) are attracted

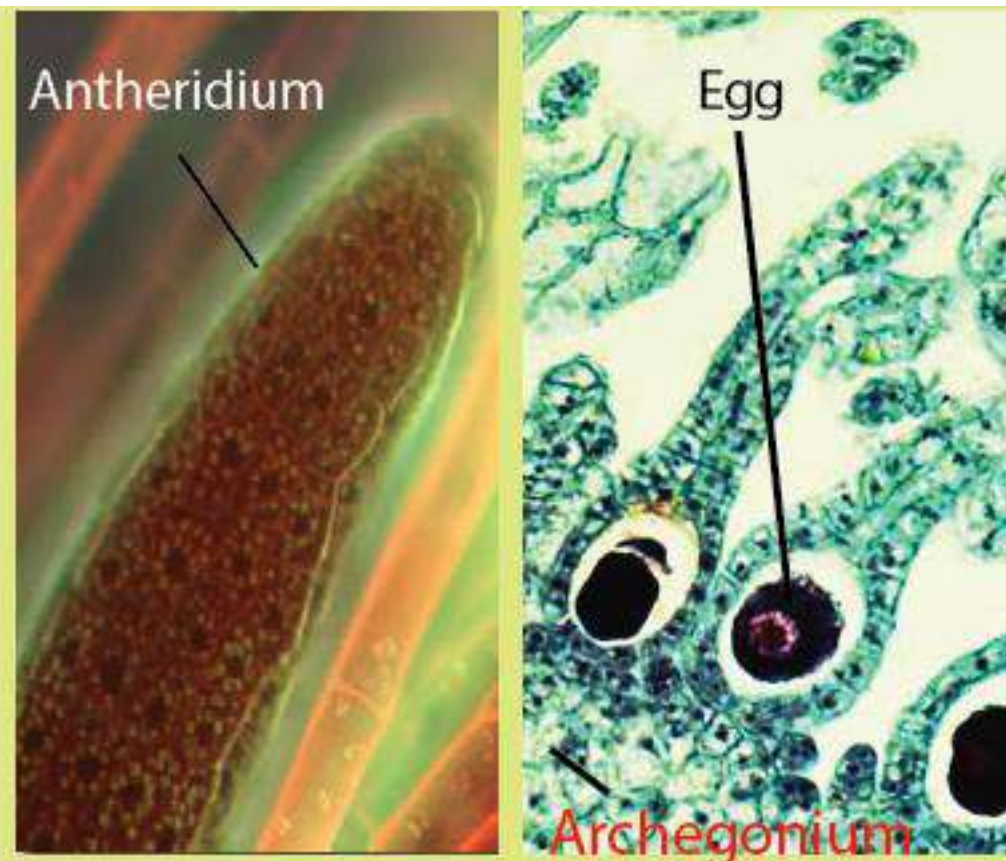

Fig. 9.3 Sex organs, male (antheridium) female (archegonium) of a bryophytic plant

towards archegonia (n) chemotactically. A single antherozoid fuses with an egg (n) thus accomplishing fertilization which results in the formation of the diploid zygote ($2n$). The zygote is retained within the female sex organ (archegonium) for some time. After a resting period the zygote develops through mitotic divisions into a **diploid embryo**. The embryo ultimately develops into a sporophyte which is also diploid.

The entire development of sporophyte thus takes place within the gametophyte plant body. Even when the sporophyte is fully developed it remains attached to the gametophyte for nourishment and protection because it does not contain chloroplasts and is unable to perform photosynthesis. There is an **alternation of generations** in the life cycle of bryophytes i.e. multicellular haploid gametophytic (gamete producing) generation alternates with the multicellular diploid sporophytic (spore producing) generation (Fig. 9.6). It is a very important phenomenon, which provides continuous genetic variabilities and selection for the best genetic make up for survival and adaptation in the changing environment(s) (as explained in a later section).

In view of the above mentioned discussion, bryophytes can therefore be defined more precisely as plants with the distinguishing characters as follows :

"Vascular system absent; gametophyte dominant; sporophyte attached to gametophyte; homosporous."

ADAPTATION TO LAND HABITAT

In general bryophytes developed the following adaptive characters for terrestrial environment:

1. Formation of a compact multicellular plant body which helped in the conservation of water by reducing cell surface area exposed to dry land conditions. Presence of cuticle further reduces loss of water by evaporation.
2. Development of photosynthetic tissues into special chambers for the absorption of carbon dioxide without losing much water and exposure to light.
3. Formation of special structures like rhizoids for absorption of water and anchorage.
4. Heterogamy (production of two types of gametes) is evolved, forming non motile egg containing stored food and motile sperms.
5. Gametes are produced and protected by the special multicellular organs (antheridia and archegonia).
6. Multicellular embryo is formed which is retained and protected inside the female reproductive body during its development.
7. Alternation of spore-producing generation (sporophyte) with gamete producing generation (gametophyte) enabled the plant to produce and test the best genetic combinations for adapting to the versatile terrestrial conditions.

CLASSIFICATION

Bryophytes are divided into three subdivisions : Hepaticopsida, Bryopsida and Anthoceropsida.

Hepaticopsida (Liverworts)

Bryophytes belonging to this subdivision are called liverworts. It includes about 900 species. Liverworts are the simplest of all bryophytes (Fig. 9.4).

They are usually found on moist rocks and on wet soil. Since they live near water therefore chances of drying out are greatly reduced.

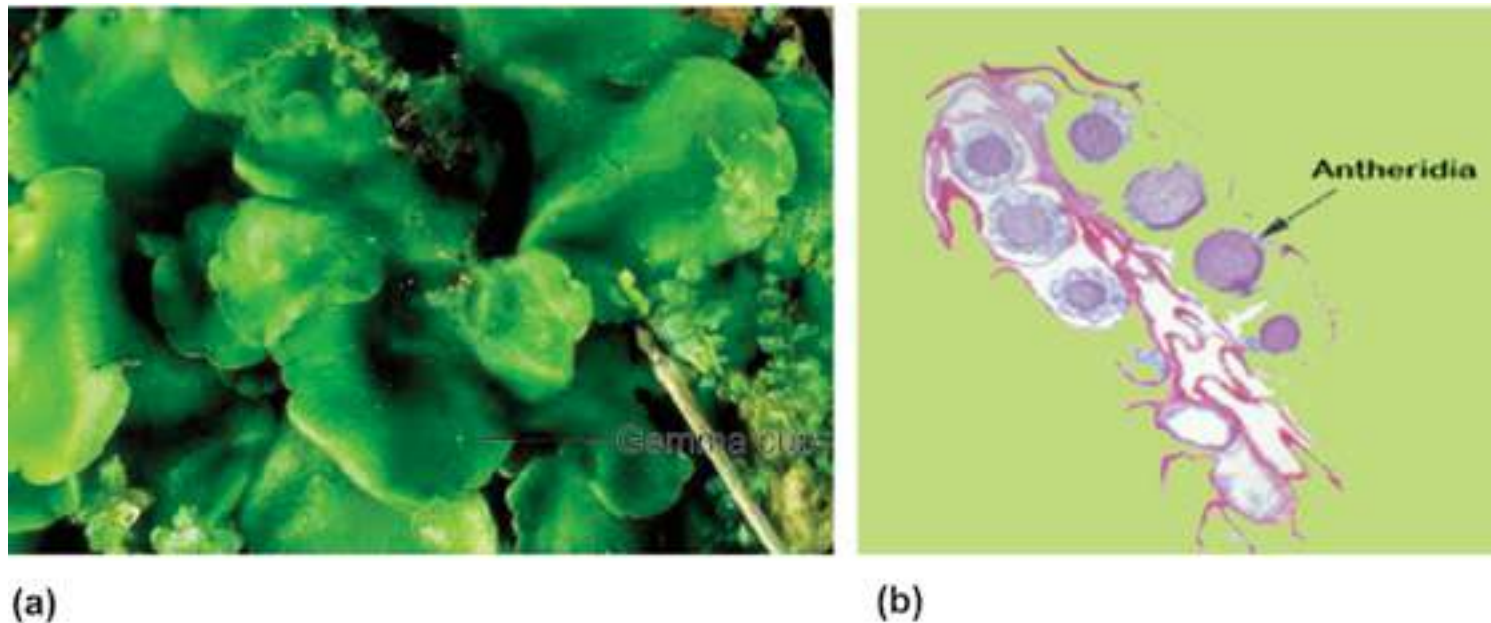

Fig 9.4 (a) *Marchantia* a typical liverwort, the gemma cups functions in asexual reproduction (b) *Porella* a leafy liverwort showing lateral antheridia bearing branch

The plant body is a gametophyte. It may be thalloid i.e. flat, or ribbon-like, usually dichotomously branched. It is attached to soil by means of rhizoids e.g. *Marchantia*, Other species tend to grow upright and are falsely leafy i.e., differentiated into a false stem, and leaves e.g., *Porella* (Fig. 9.4b). The sporophyte is dependent upon gametophyte! for nourishment and protection.

The sex organs develop on the upper surface of the thallus near the tips of the branches. Sometimes they develop on special branches on gametophyte called the **antheridiophores** and the **archegoniophores** as in *Marchantia* (Fig. 9.5).



Fig. 9.5 A Liverwort, *Marchantia* bearing sex organs, antheridia and archegonia, on special branches called antheridiophores and archegoniophores:

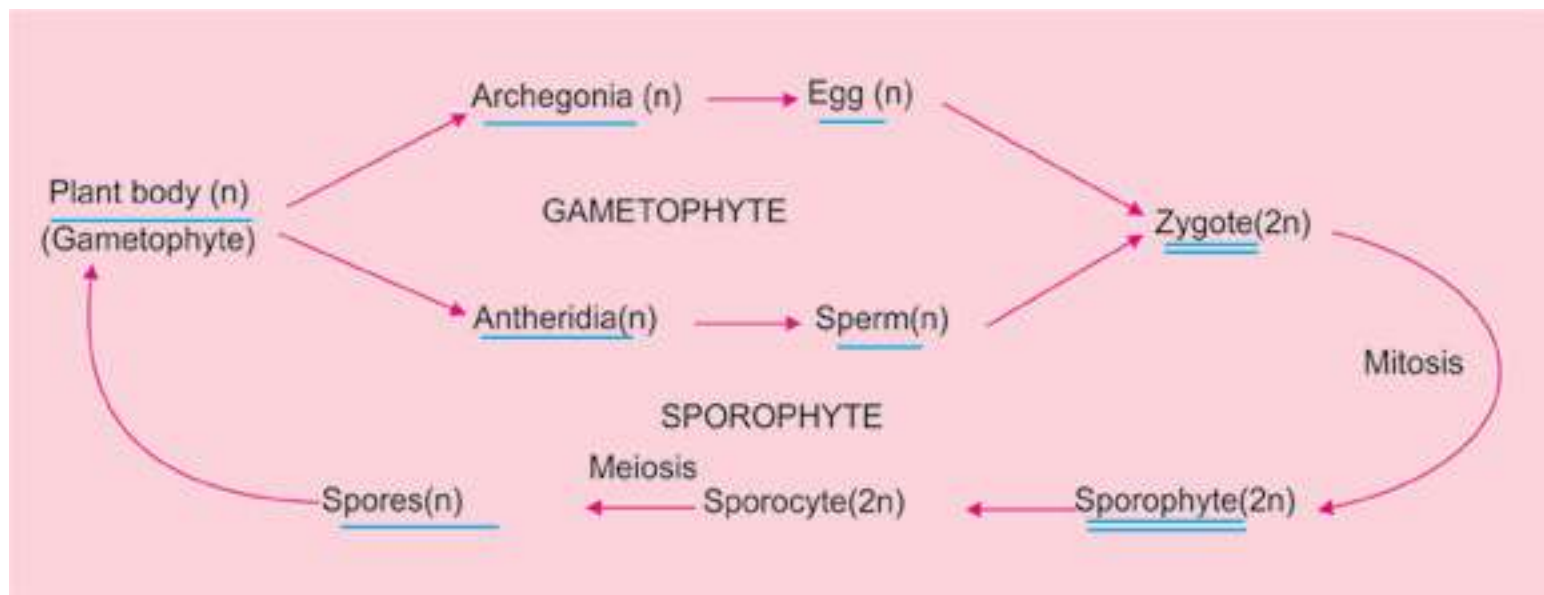

Fig. 9.6 A generalized life cycle of a Bryophyte showing alternation of generation.

Bryopsida

Like liverworts most mosses inhabit damp places. In contrast to other bryophytes they grow equally well in fairly dry places. However, water is essential in the reproduction of mosses, thus they usually grow to form cushions or mats.

Each adult moss plant, a gametophyte, is always differentiated into structures which resemble stem and leaves. Multicellular rhizoids are also present. Examples of mosses are *Funaria* and *Polytrichum* (Fig. 9.7). Archegonia and antheridia, develop on the tips of different branches on the same plant e.g., *Funaria*, or on different plants as in *Polytrichum*. The archegonia and antheridia form clusters and are mixed with sterile hairs, the **paraphyses**.

Formation of diploid sporophyte and haploid spores follow the same sequence of events of alternation of generations as in liverworts (Fig. 9.6). However, the spore of a moss, unlike that of liverworts, develops into an alga like structure, the **protonema**. Haploid moss plants (gametophyte) develop from buds on the protonema and the life cycle is completed (Fig. 9.8).



Fig 9.7 *Polytrichum*, a hair cup moss plant

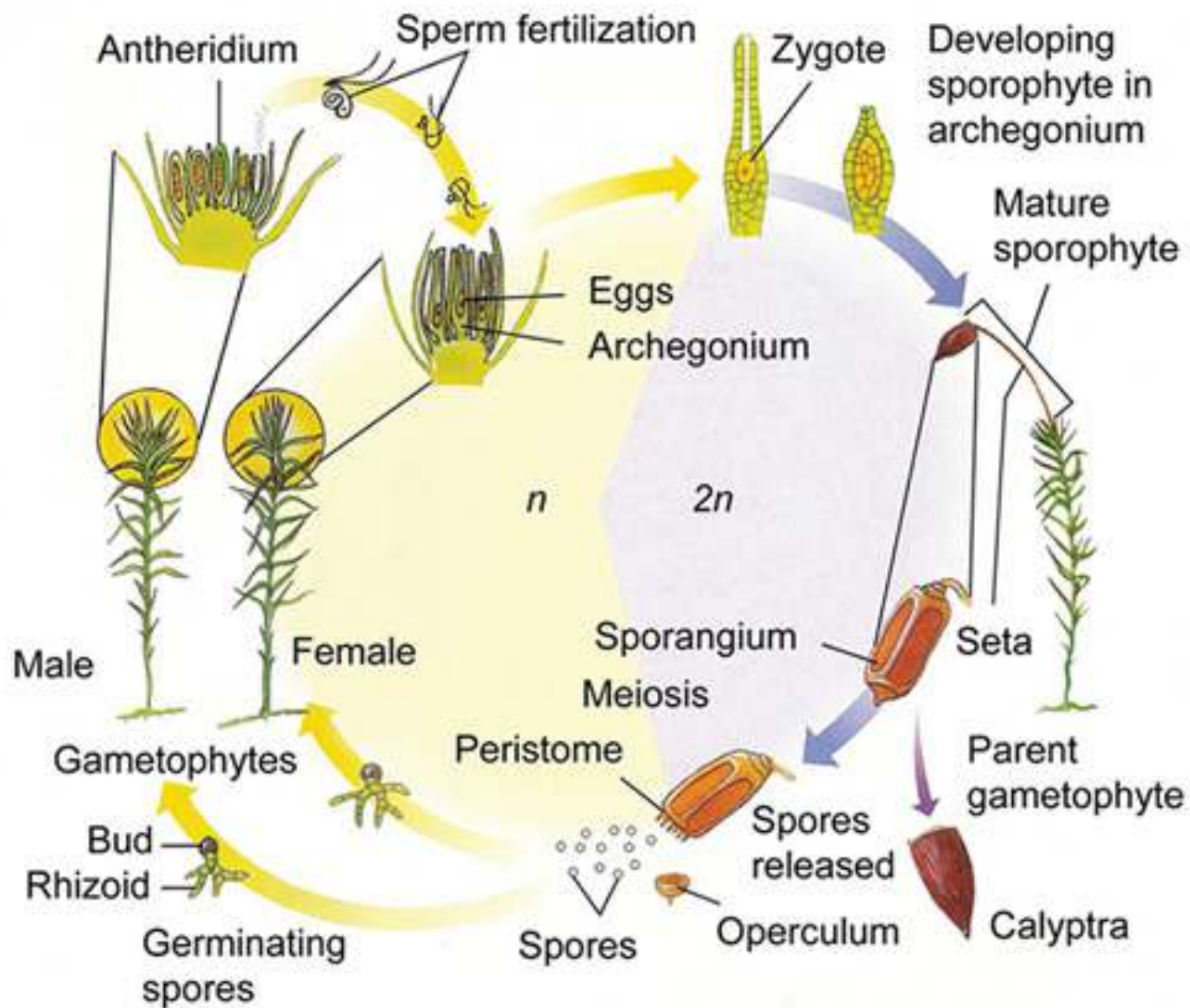

Fig. 9.8 Moss life cycle

Anthoceropsida (Horn Worts)

This group of bryophytes differs in many respects and is slightly advanced than Bryopsida and Hepaticopsida. The gametophyte is highly lobed and irregular in outline. Except for a little early stage of development, the sporophyte is not dependent upon gametophyte for nourishment and protection. Antheridia and archegonia are partially sunken in the gametophytic tissue. The sporophyte exhibit many advanced characters due to which it can thrive better on land as compared to other groups. The sporophyte has stomata and chloroplasts in the epidermis and can thus photosynthesize its own food rather than obtaining it from gametophyte. It also has a waxy cuticle to check excessive loss of water (desiccation). Furthermore, at the junction of foot and spore producing region there is a band of **meristematic** tissue. This tissue keeps on adding cells towards the spore-producing region during the formation, maturation and dispersal of spores from the opposite end. Due to the fast growth rate of this meristematic tissue the sporophyte keeps on

increasing in length for an indefinite period of time. Due to these characters the sporophyte continues to survive as such even after the death and decay of the gametophyte. One good example of Anthoceroptida is *Anthoceros* which is also found in the hilly areas of Pakistan (Fig. 9.9)



(a)

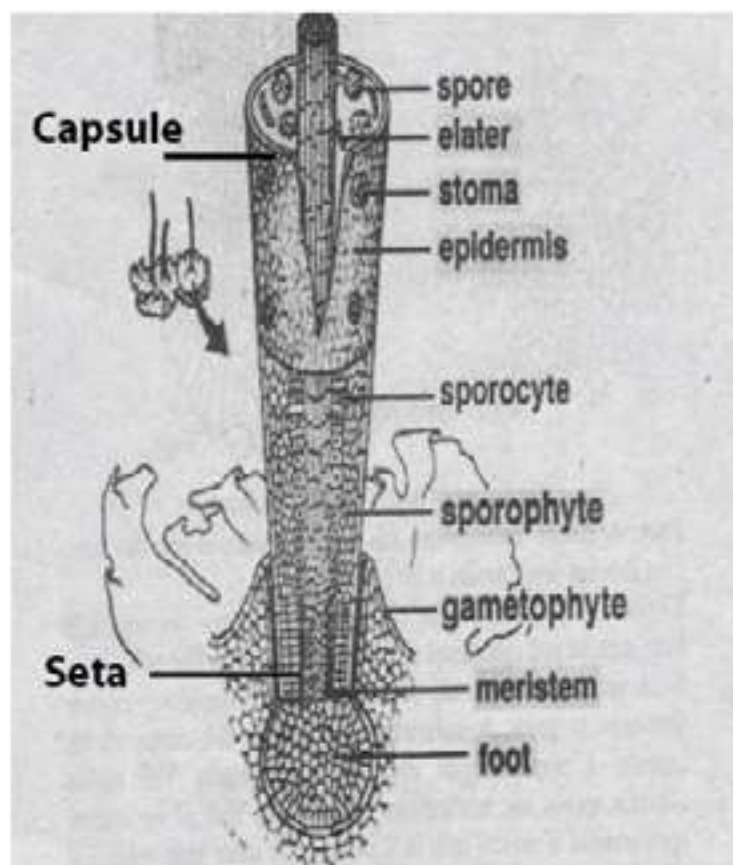

(b)

Fig. 9.9 *Anthoceros*, a hornwort (a) Gametophyte with attached horn-shaped sporophyte (b) V.S. of sporophyte.

Alternation of generations

In the life history of liverworts, mosses and hornworts there are two distinct multicellular phases or generations. These generations are haploid **gametophyte** and diploid **sporophyte**, which regularly alternate with each other. The gametophyte is the dominant generation because it is more conspicuous. It produces gametes called **spermatozoids** or **antherozoids** and eggs, therefore called gamete-producing generation. A haploid spermatozoid fuses with a haploid egg to produce diploid **oospore**.

The oospore does not produce the gametophyte directly but produces a totally different plant called **sporophyte**. The sporophyte in bryophytes is a less conspicuous generation, which is usually differentiated into **foot**, **seta** and **capsule** (also called **sporogonium**). Spores develop within the capsule by reduction division (meiosis) from spore mother cells. The sporophyte produces spores and is, therefore, called spore producing generation. The spore on germination does not develop

into a sporophyte but gives rise to the gametophyte. Thus in the life-history of a bryophytic plant, the two generations, the gametophyte and the sporophyte, regularly alternate with each other. The phenomenon of alternation of gametophyte and sporophyte in the life history of a plant is called alternation of generations (Fig. 9.10).

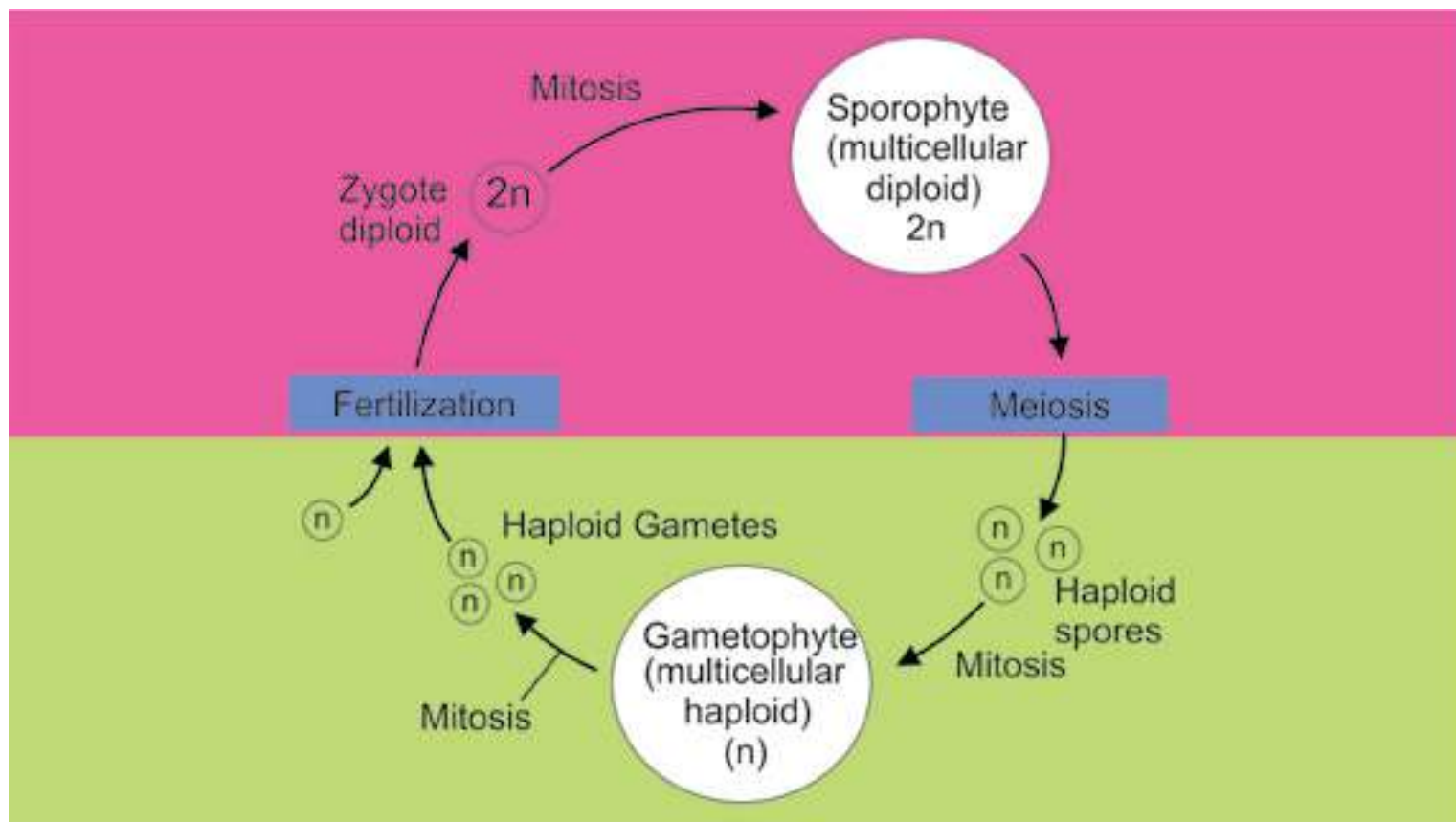

Fig. 9.10 graphic representation of the alternation of gametophytic and sporophytic generation

It should be noted that the gametophyte or haploid stage begins with spores and ends at gametes, whereas the sporophyte begins with oospore and ends at spore mother cell.

The significance of alternation of generations

During the formation of spores from spore mother cells by meiotic division reshuffling of genes occurs. As a consequence, a great variety of spores with different genetic make-up are produced. These spores in turn produce gametophytes with different genetic combinations. The gametophytes with better genetic make-up will have a better chance for survival in the environment where they occur. On the other hand, the gametophytes with less advantageous characteristics will be eliminated. There is no reshuffling of genes during gametogenesis in the gametophyte as gametes are produced after mitosis.

The oospore developing after fertilization now has a new genetic make-up as compared to the

parent. This genetic variation passes to the new sporophyte which on maturity once again produces further genetic recombination which are transferred to the gametophyte. In this natural process the sporophyte thus provide a large amount of genetic variability and nature selects the best genetic combinations. In the long run, this will allow the populations to become increasingly better adapted to their environment.

DIVISION TRACHEOPHYTA

Tracheophytes are called vascular plants because of the presence of vascular tissues i.e. xylem and phloem. These are the successful group of land plants. They are able to adapt the rough land habitat most successfully and amongst them the flowering plants today have dominated land habitat. The evolution of following complex vegetative and reproductive characteristics enabled the vascular plants in general and flowering plants specifically to become predominant flora of land :

1. Root, stem and leaves.
2. Vascular systems in stems, roots and leaves.
3. Protected sporangia, leading to the evolution of seed.
4. Pollen tube for safe and water-independent transmission of male gamete to female gamete.
5. Flower and fruit.
6. Heteromorphic alternation of generation.

The Tracheophytes are further sub-divided into four sub-divisions, Psilopsida, Lycopsidea, Sphenopsida and Prteropsida.

PSILOPSIDA (PSILOPHYTA)

In Psilopsida plants have rootless sporophytes. The stem is differentiated into an underground **rhizome** and an aerial part. Both are **dichotomously** branched. The rhizome bears rhizoids, both perform the function of root. The aerial branches are green, leafless and bear small veinless outgrowths and carry out photosynthesis. The reproductive organs of sporophyte are **sporangia** which develop at the tips of long or short branches, or on lateral sides of branches (Fig. 9.11).

Internal structure of stem is simple. Vascular tissue is narrow, central and solid without pith, with a broad cortex.

Psilopsida is considered to be the earliest group of vascular plants. Most of the representatives of this group have become extinct, for example, **Horneophyton**, **Psilophyton**, **Cooksonia** (Fig. 9.11) etc.



Fig. 9.11 *Psilotum*

(a) Dichotomously leafless branches.

(b) The erect branches of another species, showing brown sporangia.

There are only two living genera *Psilotum*, and *Tmesipeteris*.

The gametophyte is thalloid. It is colorless and underground. Its cells contain a fungus which provides food to the gametophyte and in return gets protection from it. Such beneficial symbiotic relationship among the two members (fungus and plant) is said to be symbiosis; or **mycorrhizal** association. Examples are *Psilotum*, and *Tmesipeteris*.

EVOLUTION OF LEAF

Early vascular land plants did not have true leaves or roots. They were small in size, with

dichotomously branched erect smooth aerial parts and equally strong subterranean anchoring and absorptive **rhizome**.

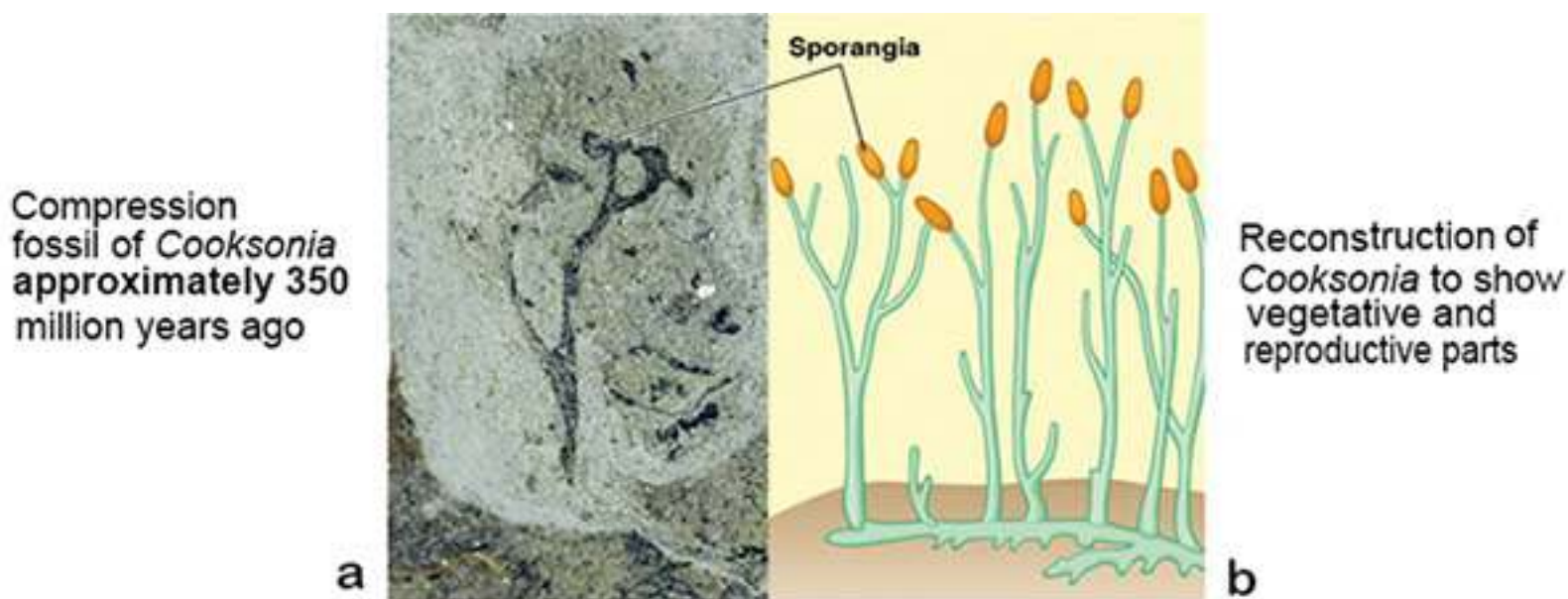

Fig. 9.12 *Cooksonia* : an early vascular plant bearing sporangia at the tips of the branches.

Cooksonia (Fig. 9.12) had the same structural layout i.e. naked stem without leaves. Such plants started to form leaves as small scale like out growths. These out growths were not supplied with vascular tissues, therefore they were not regarded as true leaves. **Lycopods** were the first plants that formed the true leaves and roots.

However in lycopods (e.g. *Lycopodium*) the leaves are small in size. Each leaf has a single undivided vein (vascular supply). Such a leaf is called **microphyll**.

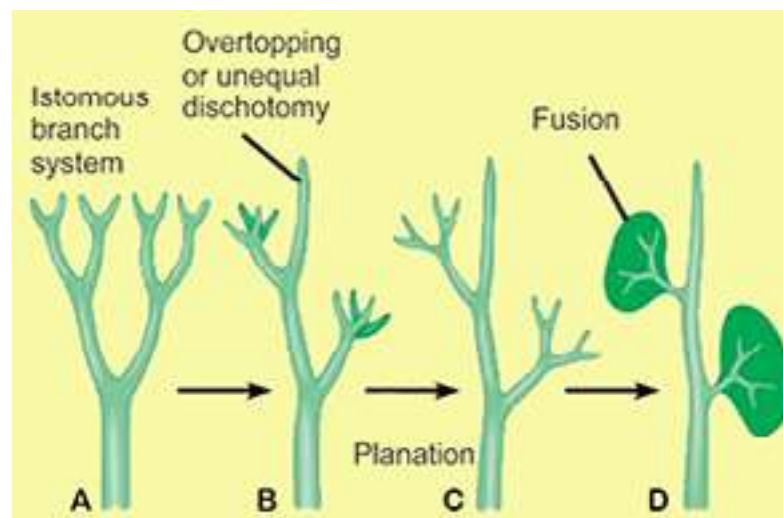

Fig. 9.13 Successive evolutionary steps in the evolution of leaf.

Large leaves having divided veins and veinlets with an expanded leaf blade or **lamina** are known as **megaphylls**. Megaphylls are characteristic for ferns and seed plants. It is suggested that evolution of megaphylls started from a dichotomous branching system in some primitive psilopsids approximately 350 million years ago. It is assumed that evolution of a megaphyll included series of successive evolutionary steps (Fig. 9.13) which are as follows :

Overtopping

The dichotomously branched aerial portion of the stem showed unequal branching. Some branches remained short while others grew and expanded at a much faster pace. All these branches grew in different planes. Such an unequal development of various branches is called **overtopping**.

Planation

Next important step was the arrangement of unequal dichotomies in one plane. This process is termed as **planation**.

Fusion/Webbing

Overtopping and planation was followed by a process known as fusion or webbing. The space between the overtopped dichotomous branches was occupied by a sheet of parenchyma cells which connected these branches forming a flat lamina or leaf blade type of structure, having many **dichotomously** branched veins (Fig. 9.13).

During the course of evolution fusion of the vascular strands resulted in net or **reticulate venation** pattern. The process of evolution of leaf was very slow and gradual which completed in more than 15-20 million years.

LYCOPSIDA

The plants of Lycopsida have sporophytes differentiated into roots, stem and true leaves. The leaves are small and single-veined, they are also called microphylls. The arrangement of leaves is spiral or opposite. The sporangia develop singly on the upper side of the sporophylls, which may or may not be arranged to form strobili (Fig. 9.14)

The sporophyte may have sporangia of one kind as in *Lycopodium* or of two kinds i.e., microsporangia and megasporangia as in *Selaginella* (Fig. 9.15).



Fig.9.14 Lycopodium: a club moss. The Sporophylls are clustered at the tips of branches into club-shaped structures called strobili

Lycopods are also called club mosses/spike mosses because of their club/spike shaped strobili and small leaves resembling mosses. On the basis of types of spores produced in the sporophyte they are thus referred to as being 'homosporous' or 'heterosporous' respectively. This condition is called homosporous and heterosporous. Selaginella resembles seed producing plants (spermatophytes) because of its heterosporous condition and some other characters. The gametophyte of Lycopoda is mainly underground.



(a) sporophylls, (b) longitudinal section of strobilus of *Selaginella* showing mega and microsporangia.

SPHENOPSIDA

In Sphenopsida (Horsetails), the sporophyte is differentiated into root, stem and leaves. The leaves may be expanded or scale-like and are always arranged in whorls. Plants belonging to this group are also called arthropytes because the whole plant body is composed of large number of joints. Main stem is not smooth, it has large number of ridges and furrows. Each node has whorl of branches. The sporangia are born on structures called **sporangiophores**, aggregated to form strobili.

Each sporangiophore has a slender stalk and an expanded disc at its free end. The sporangia appear on the underside of the disc. The thalloid gametophytes grow upon clayey soil and on mud, e.g., *Equisetum* (Fig. 9.16).



Fig. 9.16 Representative of three of the subdivisions of vascular plants (a) club moss *Lycopodium* (b) A horsetail. *Equisetum* (c) A tree fern.

PTEROPSIDA

Pteropsida is divided into three classes (i) class **Filicineae** (ii) class **Gymno spermae** (iii) class **Angiospermae**. The class **Filicineae** contains seedless plants with foliar sporangia (sporangia attached to **fronds** Fig. 9.17). The leaves are called **fronds**. When the frond is immature and young, it is coiled, this pattern of development is called **circinate vernation** (Fig. 9.19). It is an important character of this group.



Fig. 9.17 A frond bearing sporangia attached to the underside of the leaf.



Fig. 9.18 Ferns. A ostrich fern growing on a forest floor. See the coiled immature and young fronds ready to uncoil.

Class Filicineae

The Filicineae or ferns are mostly shade and moisture loving plants. A very few are able to live under dry conditions. They grow on the hills and in plains. Some are epiphytic and grow on the bark of trees. Although ferns are worldwide in distribution, they are especially abundant in the tropics. They vary greatly in size. Important ferns are *Dryopteris*, *Pteridium*, *Adiantum* and *Pteris* etc.

Adiantum (Maiden-hairfern)

Adiantum is a fern that grows along moist walls and water courses. It is a small herb consisting of stem, roots and leaves. Stem is a short, thick and underground, usually unbranched horizontally growing **rhizome**. The rhizome is protected by brownish scales (ramenta) and covered by persistent leaf basis. Fibrous adventitious roots arise from the lower side of the rhizome. Large, pinnately compound fronds arise from the upper side of rhizome. Young leaves (fiddle heads) show circinate vernation. The stipe (stalk) and rachis are black, smooth, shiny (hence called maiden hair fern). The leaflets (pinnae, and pinnules - leaflets of second order) show dichotomous venation. Sori (groups of sporangia) are born on the underside of reflexed lobes of the margins of leaflets, and are protected by bent margin of the leaflet, forming false indusium.

Life Cycle : Life cycle of *Adiantum* shows heteromorphic alternation of generation, sporophyte being dominant and gametophyte small and reduced but separate and independent. The diploid sporophyte produce large number of sori (singular-sorus). They are green, but when ripe they become dark brown. Each sorus consists of a number of sporangia covered by false indusium. The leaves bearing sporangia are called sporophylls.

Each sporangium is slightly flattened, biconvex body (capsule) born on a multicellular stalk. The capsular wall consists of a single layer of flat, thin walled cells. The edge of the capsule is made up of two parts, the annulus and the stomium. The annulus occupies three fourth of the edge and remaining one fourth is the stomium. Annular cells have their radial and inner walls thickened. The stomial cells are thin-walled. Inside the sporangia, haploid spores are formed by reduction division, from diploid spore mother cells. The annulus of the sporangium contracts in dry weather, the stomial cells being thin-walled rupture and spores are dispersed by wind.

When a spore falls on a moist soil, it germinates at a suitable temperature and produces a haploid gametophyte or prothallus.

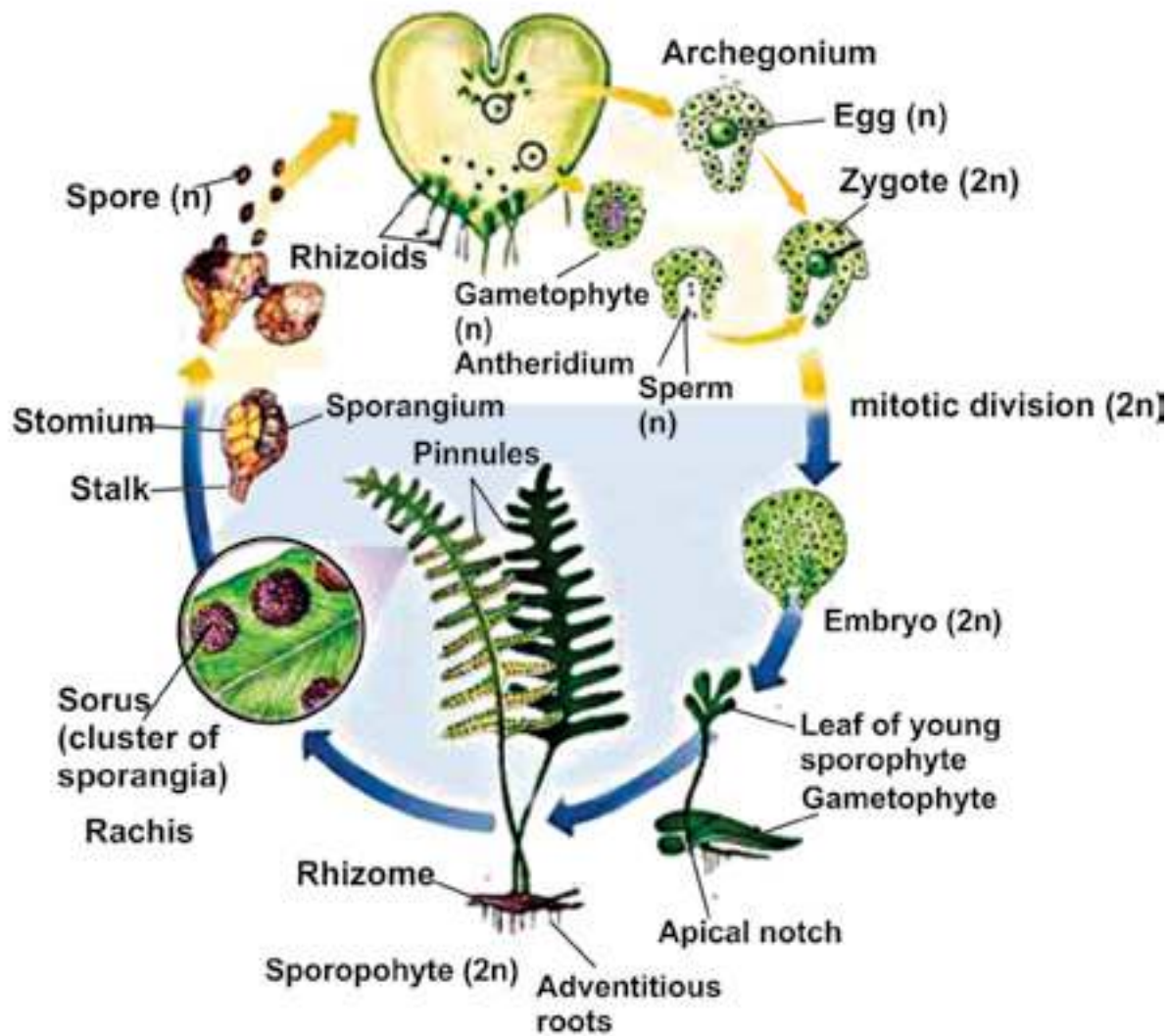

Fig. 9.19 Life history of *Adiantum*

The prothallus (gametophyte) is an autotrophic, small, flat, heart shaped structure. At the anterior end of the prothallus is a notch in which lies the growing point. Its size is about 8mm at its longest diameter. It is horizontally placed on the soil, and has unicellular rhizoids on its lower surface towards the posterior end. The rhizoids fix the prothallus to the soil and absorb nutrients for it. It is composed of rounded thin walled cells. The margin of the prothallus is one-celled thick but the middle part is many-celled and is cushion-like.

The prothallus is monoecious i.e., male and female sex organs appear on the under-surface of the same prothallus. In the mature prothallus, archegonia occur near the notch and the antheridia are scattered among the rhizoids.

Each antheridium produces numerous spermatozoids which are spirally coiled and multiciliated..

The archegonium consists of a venter and a neck. The venter contains the egg or oosphere and is embedded in the cushion of the thallus. The antherozoids reach the archegonium, by swimming in water, Fertilization occurs and an oospore is formed. The oospore forms the sporophyte. Young sporophyte is first attached to the gametophyte but later becomes independent. The life history of this fern is shown in Fig 9.19.

EVOLUTION OF SEED HABIT

A review of the kingdom Plantae indicates that the seed-plants (spermatophytes) predominate over non-seed vascular plants.

One of the most significant events in the history of land plants' was the development of seed habit. It was an important change in the reproductive system of the vascular plants which occurred approximately 390 million years ago. First complete seeds appeared approximately 365 million years ago during late Devonian times. Technically a seed may be defined as a fertilized ovule. An ovule is an integumented indehiscent megasporangium. Integuments are specialized protective coverings around megasporangium which vary in number. All seed producing plants are called spermatophytes. Various steps involved in the evolution of seed habit are as follows.

1. Evolution of heterospory.
2. Retention and germination of megaspore within the megasporangium.
3. Development of protective layers around megasporangium.
4. Reduction to a single functional megaspore per sporangium.
5. Development of an embryo sac within the sporangium.
6. Modification of distal end of megasporangium for pollen capture.

1. Evolution of heterospory

Primitive vascular land plants produced one kind of spores, a condition called **homospory**. All groups of land plants up to **pteridophytes** are **homosporous**. During the early phase of evolution some plant groups started producing two different types of spores, the smaller ones called **microspores** and the larger ones known as **megaspores**.

The microspores produced inside microsporangia germinate to form male gametophyte or the **microgametophyte**, whereas the megaspores germinated to form female gametophyte or

megagametophyte.

2. Retention and germination of megaspore within the megasporangium

During the usual reproductive cycle in the heterosporous vascular land plants, the megaspores are used to be shed and dispersed soon after their formation in order to germinate into female gametophyte. However in some plants (e.g. Selaginella) the megaspore is not allowed to escape from megasporangium immediately after its formation. In others the megaspore is permanently retained within the megasporangium. Here, within the confines of the megasporangium wall the megaspore germinates to form egg containing female gametophyte.

3. Development of protective layers around megasporangium

Some branch like structures of sporophyte surrounding the megasporangium fused around to megasporangium to form protective envelope or integument. The megasporangium tightly locked by integuments becomes totally indehiscent. This important change led to the evolution and formation of the ovule, which is nothing but an integumented indehiscent megasporangium. In this way more protection is accorded to the egg-containing apparatus in terrestrial environment.

4. Reduction to a single functional megaspore per sporangium

Each megaspore mother cell within a megasporangium used to produce four gametophytes. There was a competition for space and food among the four gametophytes. Soon the early vascular plants adopted a new strategy i.e., only one megaspore is selected for further development into a healthy female gametophyte while the remaining three are aborted.

5. Development of an embryo sac within the sporangium

The single healthy megaspore retained within the megasporangium germinates to form an egg containing female gametophyte called an **embryo sac**.

6. Modification of distal end of megasporangium for pollen capture

When most of the structural and functional changes leading to the development of seed habit were completed, another important modification took place in the megasporangium which was now integumented, indehiscent and permanently attached to - the sporophyte. The distal end of the megasporangium became modified for capturing pollen (microspore containing male gametophyte).

Pollen after being trapped in the distal cavity of the megasporangium produces pollen tube which carry male gametes deep into the embryo sac to fertilize the egg, forming a zygote, that forms an embryo. The megasporangium (ovule) after fertilization is transformed into a seed, the integuments

becoming the seed coats.. The seed offers maximum degree of protection to a developing embryo under the unfavorable terrestrial environment. The development and evolution of seed habit was a great success and a giant leap which ultimately enabled Plants to colonize land permanently.

Class Gymnospermae

Gymnosperms are one of the successful groups of seed plants of worldwide distribution. They constitute about one-third of the world's forests. The gymnosperms are heterosporous plants which produce seeds but no fruits. The term gymnospermae literally means 'naked seeded' (Gymno= naked, spermae= seed). The ovules in these plants are usually borne on the exposed surfaces of fertile leaves (megasporophylls). These ovules, unlike those of angiosperms are not enclosed but lie naked on the surface of fertile leaves.

Like Filicinae, they show regular heteromorphic alternation of generations. They have independent, dominant sporophyte but less conspicuous, dependent gametophyte. The female gametophyte is permanently retained within the ovule. The two kinds of spores are microspores and megaspores which develop on microsporophylls and megasporophylls respectively. The megasporophylls bearing ovules are not folded and joined at the margins to form an **ovary**. For this reason the seeds lie naked on the mega sporophylls, (Fig. 9.20a).

The important genera are *Cycas* (sago-palm) (Figs. 9.20-a), *Pinus* (Pine), *Taxus* (Yew), *Picea* (Hemlock) and *Cedrus* (deodar) *Ginkgo* (Fig. 9.20-b) etc.



Fig 9.20(a) *Cycas* tree-habit and general organography



Fig 9.20 (b) *Ginkgo biloba*

Pinus- Life Cycle

The Pine is a conifer. The main plant body is sporophyte which produces spores after reduction division of spore mother cell in sporangia. Conifers are heterosporous. Microspores and megaspores are produced in microsporangia and megasporangia respectively. Sporangia (i.e., micro and megasporangia) are produced on respective cones (male cones and female cones) on the same plant.

The male cones are small in size and are produced in clusters on an axis. Each male cone consists of microsporophylls which contain microsporangia. Microspore germinates to form a small inconspicuous male gametophyte (also called as microgametophyte) within the spore wall. Such a microspore of seed plants that contains the microgametophyte including the gametes is called a pollen grain (Plural = pollen).

Pollen are produced in great numbers and are transported by wind. Pollen grain in Pinus has two wings attached to its lateral sides. Due to wings, pollen can float in air for a longer period of time and can travel long distances. The gymnosperms have successfully evolved this totally new mechanism of transfer of male gamete to the female gametophyte through wind which has made them independent of water for this purpose. This is an important improvement and evolutionary adaptation to survive in the harsh dry terrestrial (land) environment.

The female cones are large and conspicuous. Each female cone is composed of large number of spirally arranged scales, the megasporophylls which are woody in texture. At the base of each scale two ovules are present. An ovule is actually a megasporangium which is protected by an integument. Each megasporangium has a single diploid megaspore mother cell. The megaspore mother cell divides meiotically to produce four haploid megaspores. The functional megaspore (n) undergoes mitosis to produce female gametophyte or an embryo sac. The embryo sac contains one to several archegonia. The archegonia contain the female gamete or an egg.

During pollination the pollen land directly on the ovules. Only few pollen are able to germinate to form pollen tubes through which male gametes are transferred to the embryo sac for fertilization. More than one egg can be fertilized to form several zygotes, but one zygote usually survives to form a single embryo. After fertilization the ovule becomes the seed. The seeds now contains an embryo along with some stored food material. The seed upon germination gives rise to a new sporophyte plant.

In the life cycle of Piuns, the dominant diploid sporophyte generation alternates with inconspicuous

haploid gametophyte generation (Fig. 9.21).

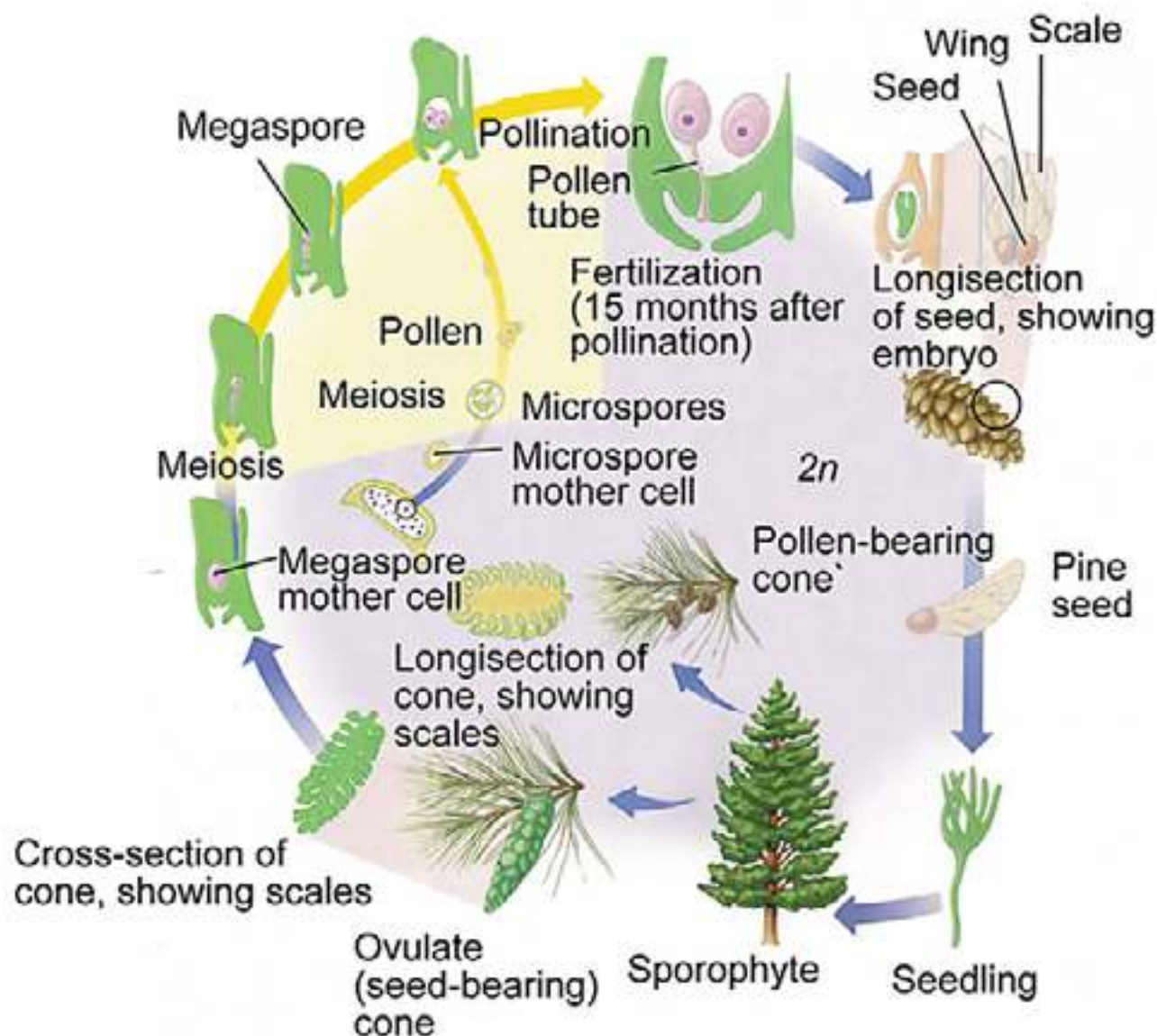

Fig.9.21 Life Cycle of Pinus

Class Angiospermae

The term angiosperms literally means “enclosed seeded” (Angio=close Sperm = seed). In these plants fertile leaves bearing ovules are folded and joined at the margins to form ovaries. The ovary after fertilization is changed into a fruit, containing seeds.

Angiosperms make up 235,000 of the 360,000 known species of plants. They are heterosporous, autotrophic plants. These are highly evolved of all the plants on the earth. The plants produce flowers, fruits and seeds.



Fig. 9.22 Some of the remarkable diversity of angiosperms is shown in these photographs. The species shown here are Dicots (a) Fragrant water lily, (b) wild geranium, (c) Indian pipe (a parasite) an angiosperm that lacks chlorophyll.

Life Cycle of an angiospermic plant

The adult plant is a diploid sporophyte mostly differentiated into roots, stem and leaves. At maturity it produces flowers. A flower is a modified shoot which consists of a pedicel, thalamus or torus, and floral leaves (sepals, petals, stamens and carpels). Thalamus and floral leaves, especially the stamens and the carpels, are so modified, that they do not even look like stem and leaves respectively. The sepals and petals are non-essential or non-reproductive parts, and stamens and carpels are the essential or reproductive parts of the flower.

The sepals and the petals protect the stamens and the carpels. They also attract insects for pollination. When the pollination is over, the sepals usually and the petals always fall off.

The anther contains microspore mother cells which produce haploid microspores through meiosis. Each microspore germinates to produce male gametophyte. Such microspores containing male gametophytes are called pollen.

The carpel consists of a basal broader part, the ovary, the style and the terminal part of the style, the stigma. The ovary contains ovules. The ovule consists of an integument (covering) and a tissue, the nucellus present inside.

After pollination, the pollen grain is transferred to the stigma. Here it germinates to form a pollen tube. The nucleus of the microspore divides by mitotic divisions to form two male gametes and the tube nucleus. At this stage of development, the pollen grain is called male gametophyte. In the meantime certain changes occur in the ovule leading to the formation of female spore (megaspore). The megaspore develops into female gametophyte. This consists of seven cells only. One of these

cells is the egg or oosphere.

The pollen tube grows through the style, enters the ovule and then reaches the female gametophyte. Here it discharges the male gametes. The egg and one of the two male gametes fuse to form the oospore. The second male gamete fuses with the secondary nucleus to form endosperm nucleus (**double fertilization**). The oospore develops into an embryo and endosperm nucleus develops into a multicellular nutritive tissue, the endosperm.

Animation 9.2: Angiosperm Reproduction
Source and Credit: amoebasisters

Seed Formation

Meanwhile, the integuments of the ovule form testa and tegmen and ovary wall develops into the fruit. Seeds usually undergo a period of rest and then under suitable conditions, germinate and produce a seedling which gradually changes into a sporophyte (Fig. 9.23).

Thus an alternation of dominant sporophyte generation($2n$) occurs with inconspicuous gametophyte generation(n).

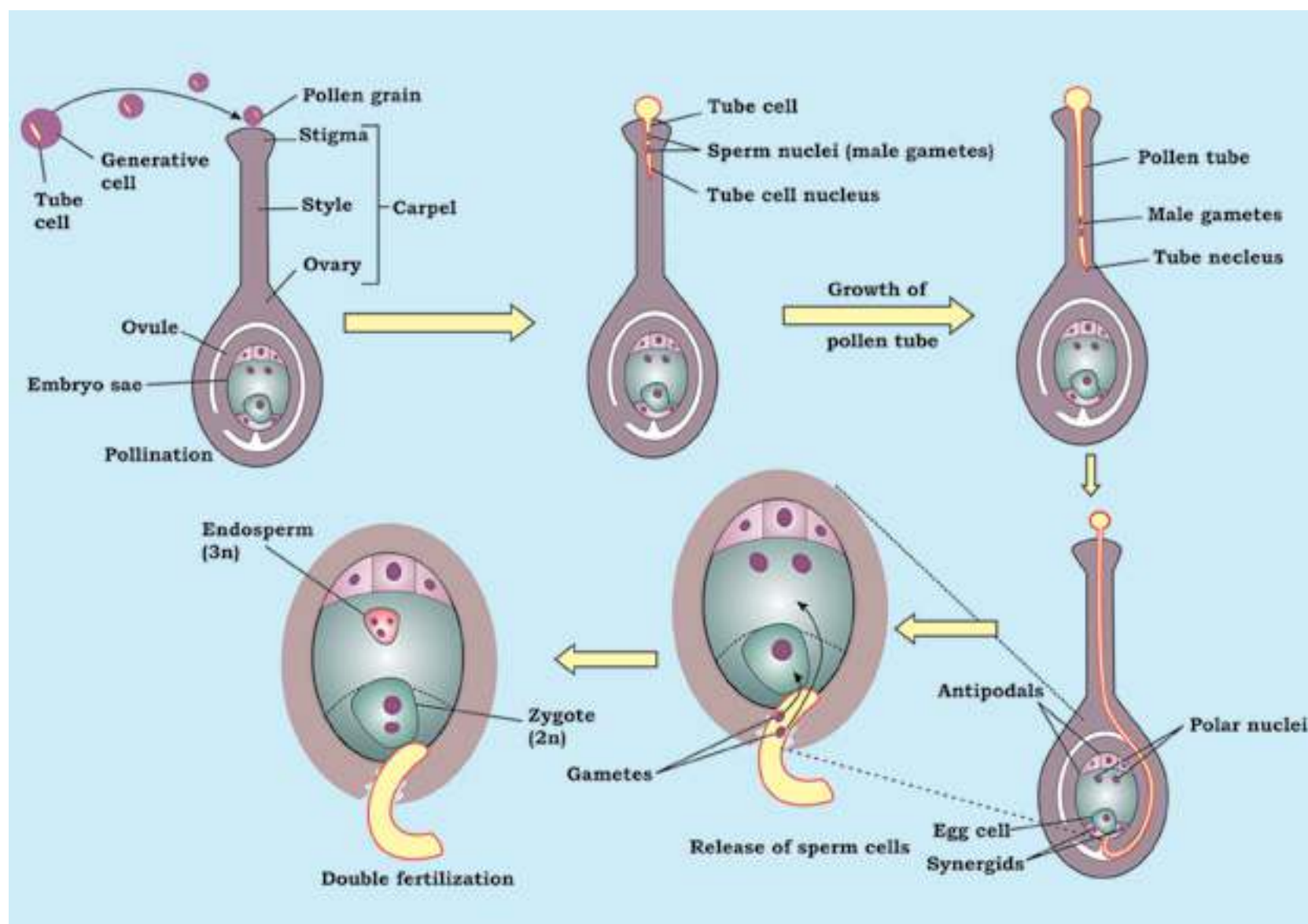

Fig. 9.23 Life Cycle of an angiospermic plant

Double Fertilization

Double fertilization is a special process found in Angiosperms. In this two male gametes fuse with two cells simultaneously. A male gamete (n) fuses with egg (n) to form a diploid zygote ($2n$) which develops later into an embryo and second male gamete (n) fuses with another female cell called fusion nucleus ($2n$) resulting into a triploid ($3n$) endosperm cell, which develops into food storing

endosperm tissue. It is an important evolutionary advancement in which food storage in fertilized ovule is made only on fertilization i.e. formation of zygote. This actually helps the plant to economize its food resources.



Classification of Angiosperms

The class Angiospermae is divided into two sub-classes, the Monocotyledonae (with one cotyledon) and the Dicotyledonae (with two cotyledons), according to the number of cotyledons in the embryo.

The plants included in the Monocotyledonae are called **Monocotyledonous** plants or Monocots. The plants included in the Dicotyledonae are called **Dicotyledonous** plants or Dicots. A few distinguishing characters of the two classes are given below:

Fig. 9.24 Comparison of Dicot and Monocot

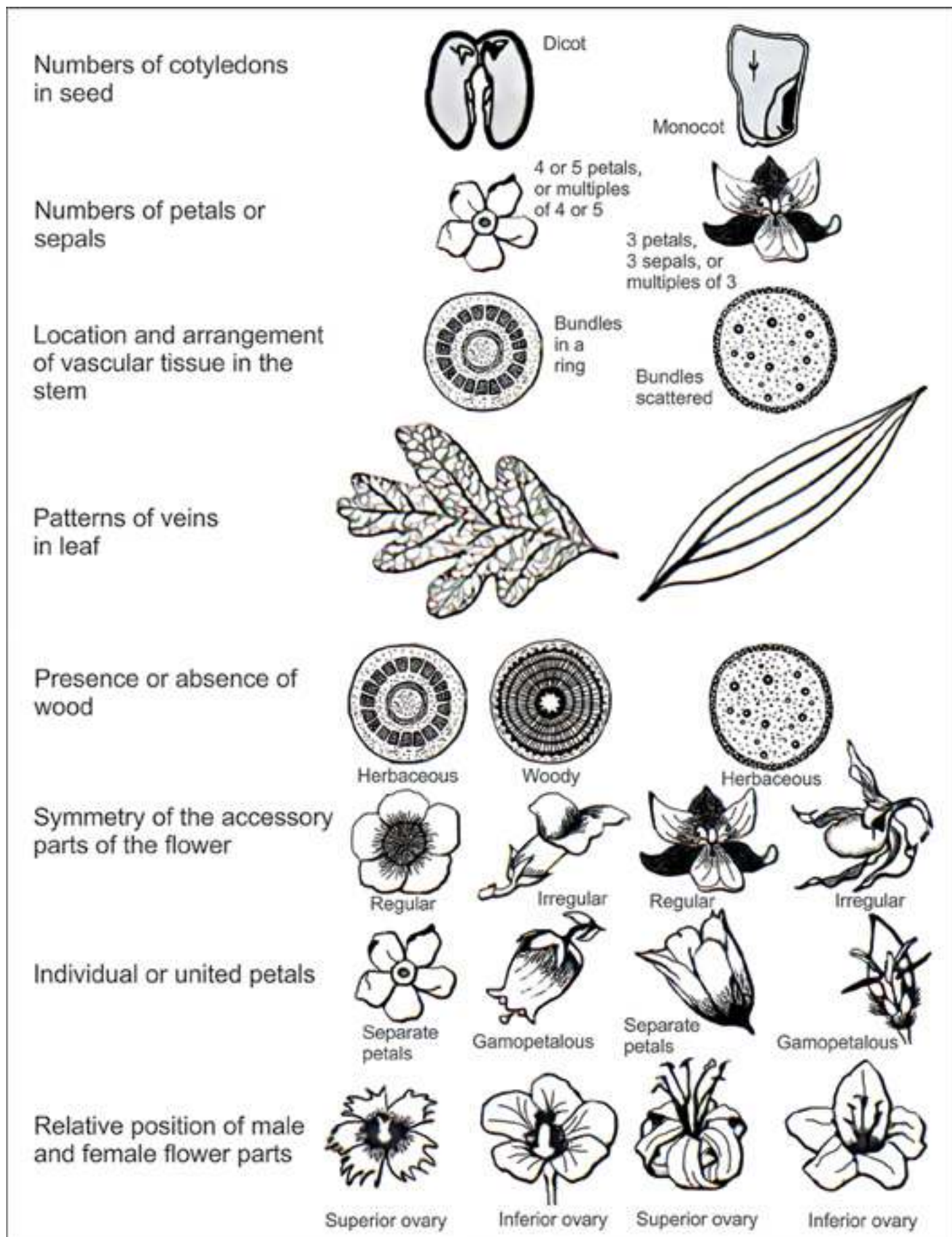

Angiospermic Families

Some Angiospermic families are described below :

1. Rosaceae (Rose family).
2. Fabaceae (Pea family).
3. Mimosaceae (Acacia family).
4. Solanaceae (Potato family).
5. Caesalpiniaceae (Cassia family).
6. Poaceae (Grass family).

ROSACEAE (Rose Family):

A family with about 100 genera and 2000 species is distributed over most of the earth. In Pakistan 29 genera and about 213 species are reported.

Familiar Plants: *Pyrus* (pear); *Rosa* (rose); *Malus* (apple); *Fragaria* (strawberry) etc.

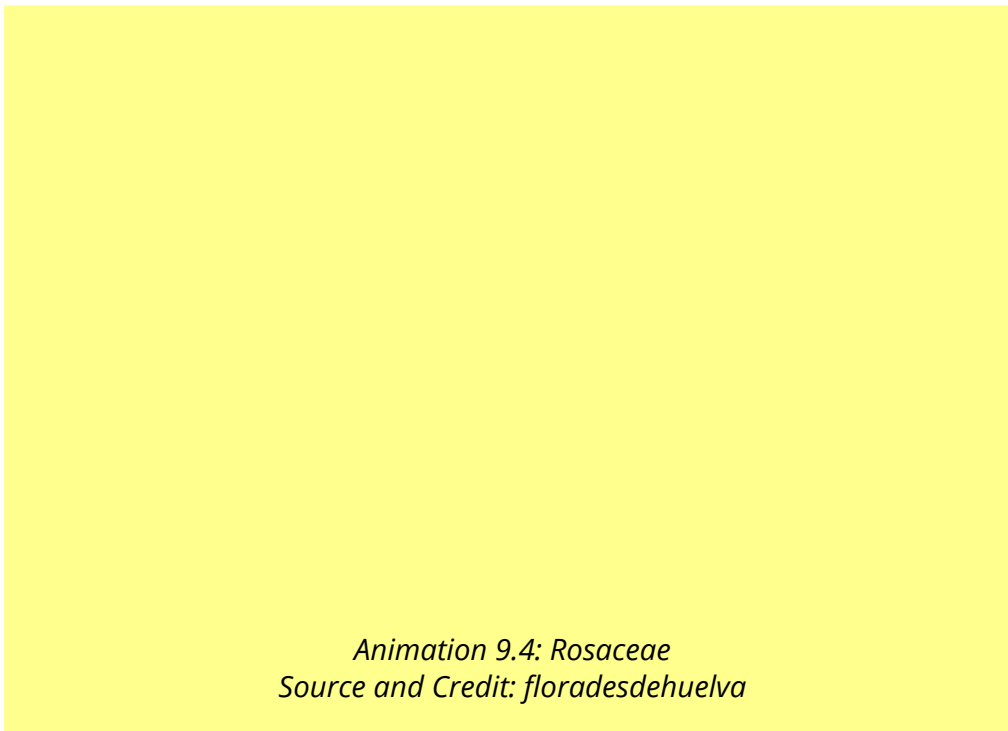

*Animation 9.4: Rosaceae
Source and Credit: floradesdehuelva*

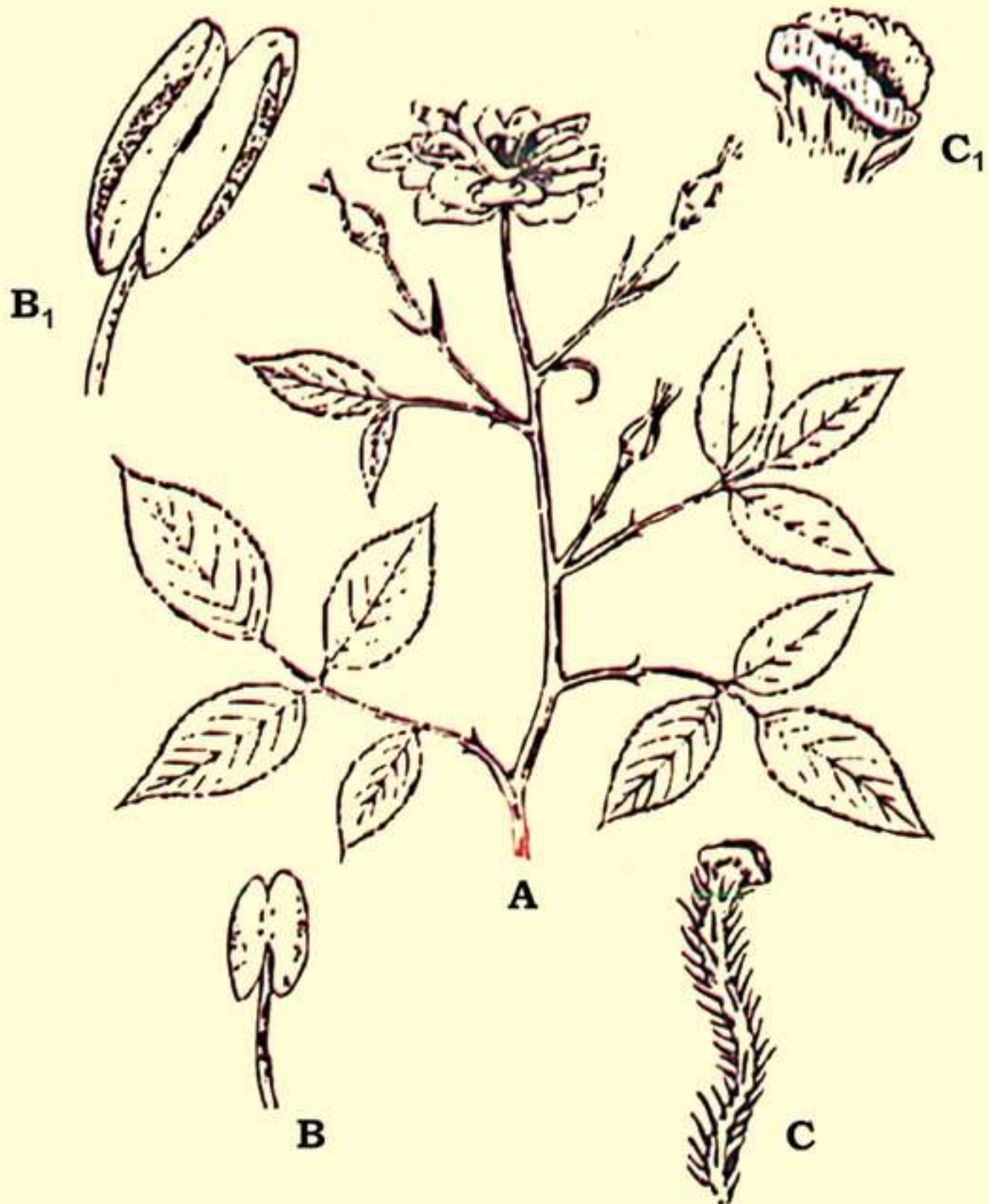

Fig. 9.25 Rosaceae : A-twig; B-young stamen; B1-enlarged open anther, showing pollen in it; C-style hairy and stigma bilabiate; C1-enlarged bilabiate stigma.

Vegetative Characters

Plants are trees, shrubs and herbs. Stem of the shrubby plants usually have spines. Leaves are alternate, rarely opposite, simple or compound, with paired stipules, which are sometimes adnate to the petiole; spines may also occur on the rachis.

Floral Characters

Inflorescence is variable, solitary or may be racemose or cymose cluster. Flowers are mostly bisexual, and actinomorphic, often perigynous to some degree, usually showy and scented. **Calyx:** 5 sepals rarely 4, united at the base. **Corolla:** Petals 5, or numerous in multiple of 5, which are free rosaceous, large and showy. **Androecium:** Numerous stamens, sometimes only 5 or 10. **Gynoecium** is of 1 to numerous separate carpels or variously united, ovary generally superior sometimes inferior; **Placentation** basal, when the carpel is one or apocarpous, but axile when the carpels are many and syncarpous (fused).

Economic Importance : Economic importance of this family is great in providing the pleasure and welfare to mankind. The members of this family are important in temperate regions for fruit and ornamentals. Perhaps they rank third in commercial importance in the temperate zone among the families of flowering plants.

Important fruits are Apple, Pear, Peach, Almond, Apricot, Strawberry, etc.

A large number of plants are ornamental and are grown in gardens for their beautiful and scented flowers. The most widely cultivated genus for decorative purpose is Rosa, Rose which has been grown in gardens since ancient times and whose named cultivars are now numbered in thousands. Many other genera are also grown for their beautiful flowers in the parks and gardens.

The branches of *Crataegus* provide excellent walking sticks and wood. The wood of *Pyrus pastia* is used for making tobacco pipes.

In Asian countries the petals of common rose usually called gulabs are used in making gulkand, and are also used in extraction of an essential oil (rose oil) used as perfume, when distilled with water the petals give Rose-water or Ark-Gulab, which is used for curing eye disease, and for many other purposes.

SOLANACEAE: Night Shade or Potato Family

It is family of about 90 genera and 2000 species of tropical and temperate distribution. In Pakistan 14 genera and about 52 species are reported, Nasir (1985).

Familiar Plants: *Solanum tuberosum* (Potato), *Nicotiana tabacum* (Tobacco), *Lycopersicon esculentum* (Tomato), *Capsicum frutescens* (Red pepper).

Vegetative Characters : Plants including in this family are herbs, shrubs, sometimes trees or vines. Stem is hairy or prickly. **Leaves** are alternate or rarely becoming opposite in the floral region, simple, petiolate, rarely sessile.

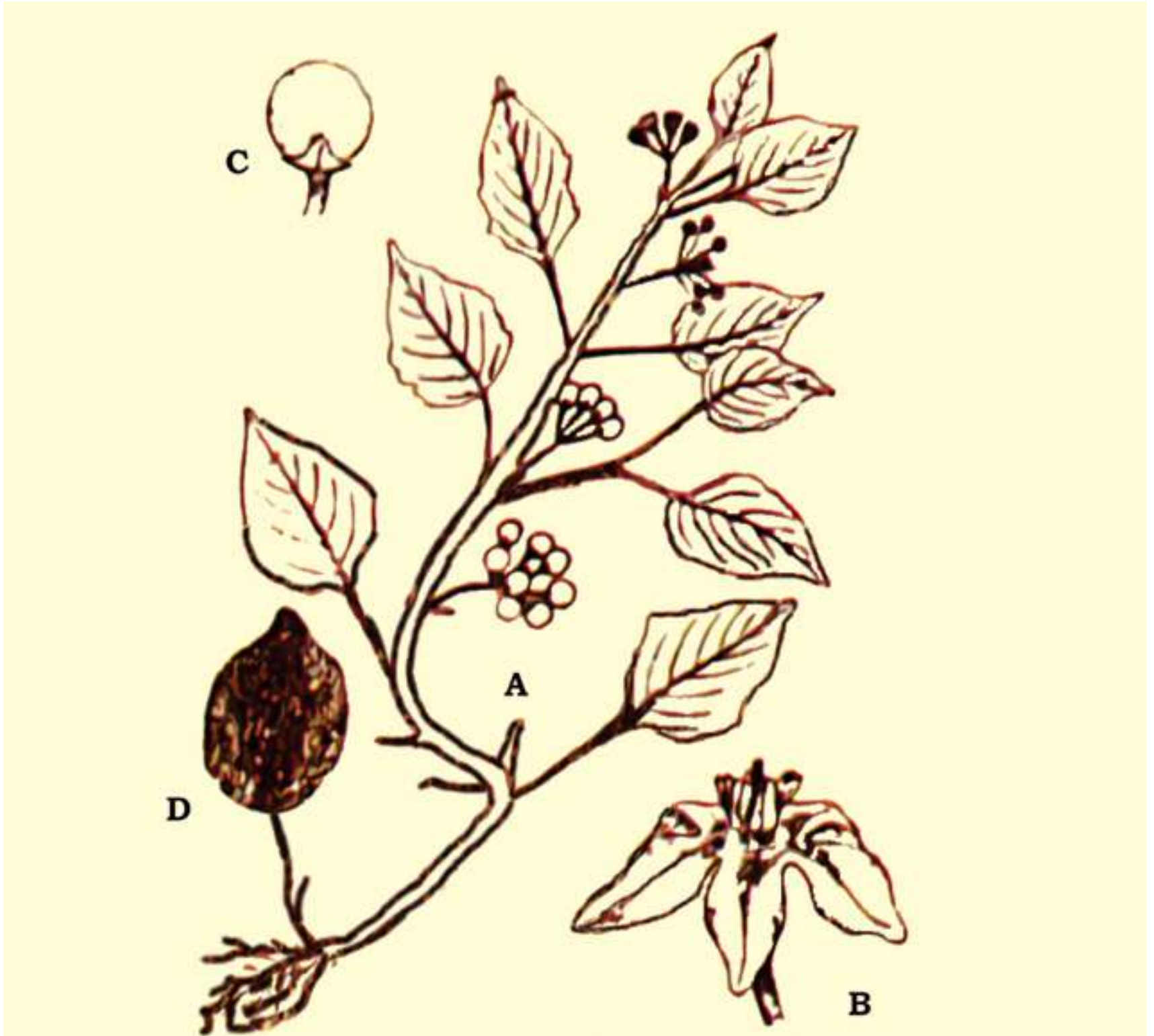

Fig. 9.26 Solanaceae : *Solanum nigrum*, A - twig, B-Flower C-fruit, D-seed

Floral Characters

Inflorescence: Typically an axillary cyme or combination of cymes, sometimes helicoids, or axillary umbellate cymes. **Flowers:** Mostly bisexual, usually actinomorphic or weakly zygomorphic, hypogynous, usually pentamerous. **Calyx:** United 5 sepals, usually persistent. **Corolla:** United 5 petals, corolla rotate to tubular. **Androecium:** Stamens 5, free but inserted on the corolla tube (epipetalous) rarely stamens 4 and didynamous (arranged in two whorls of 2 each). **Gynoecium:** A compound pistil of 2 united carpels; ovary obliquely placed, superior, bilocular, or imperfectly 4-locular by false septum; **Placentation** axile.

Economic Importance : Members of the family Solanaceae provides drugs and food, some are weedy, some are poisonous, and others are handsome ornamentals. The most important plant in the family is *Solanum tuberosum* (Potato-white or Irish Potato). In Ireland people are completely dependent on Potatoes.

Lycopersicum esculentum (tomato), the favorite home garden vegetable, was once believed to be poisonous.

Other important food plants are *Solanum metangena* (egg plant or brinjal). The fruit of *Capsicum annum* and *Capsicum frutescens* are rich in vitamin C and A, are used as condiment. *Physalis* (Ground-Cherry) produces an edible fruit enclosed in a bladder like persistent calyx, the husk, giving the name husk tomatoe.

Another plant of great commercial value is *Nicotiana tabacum* the leaves of which are dried and made into tobacco, which is used in making cigarettes. Many members of this family yield powerful alkaloids, e.g. *Atropa belladonna*, *Datura* which are rich in atropine and daturine respectively are used medicinally.

Many plants are cultivated in the gardens for their beautiful flowers, these includes *Petunia*, *Nicotiana*, *Cestrum* and *Solanum* etc.

FABACEAE: (Papilionaceae) Pea Family

A family of about 400 genera and 9000 species, the members of this family occurs all over the world, but particularly in the warm temperate regions. In Pakistan about 82 genera and about 587 species have been reported.

Familiar Plants: *Lathyrus odoratus* (Sweet pea), *Arachis hypogea* (Peanut), *Cicer arietinum* (Chick Pea) and *Dalbergia sissoo* (Shisham).

Vegetative Characters : Habit: Trees shrubs or herbs. Stem: Herbaceous, or woody or climber by tendrils (wiry, coiled thread like structures). Leaves: Compound or rarely simple, sometimes partially or completely modified into tendrils, alternate, stipulate; stipules mostly leafy.

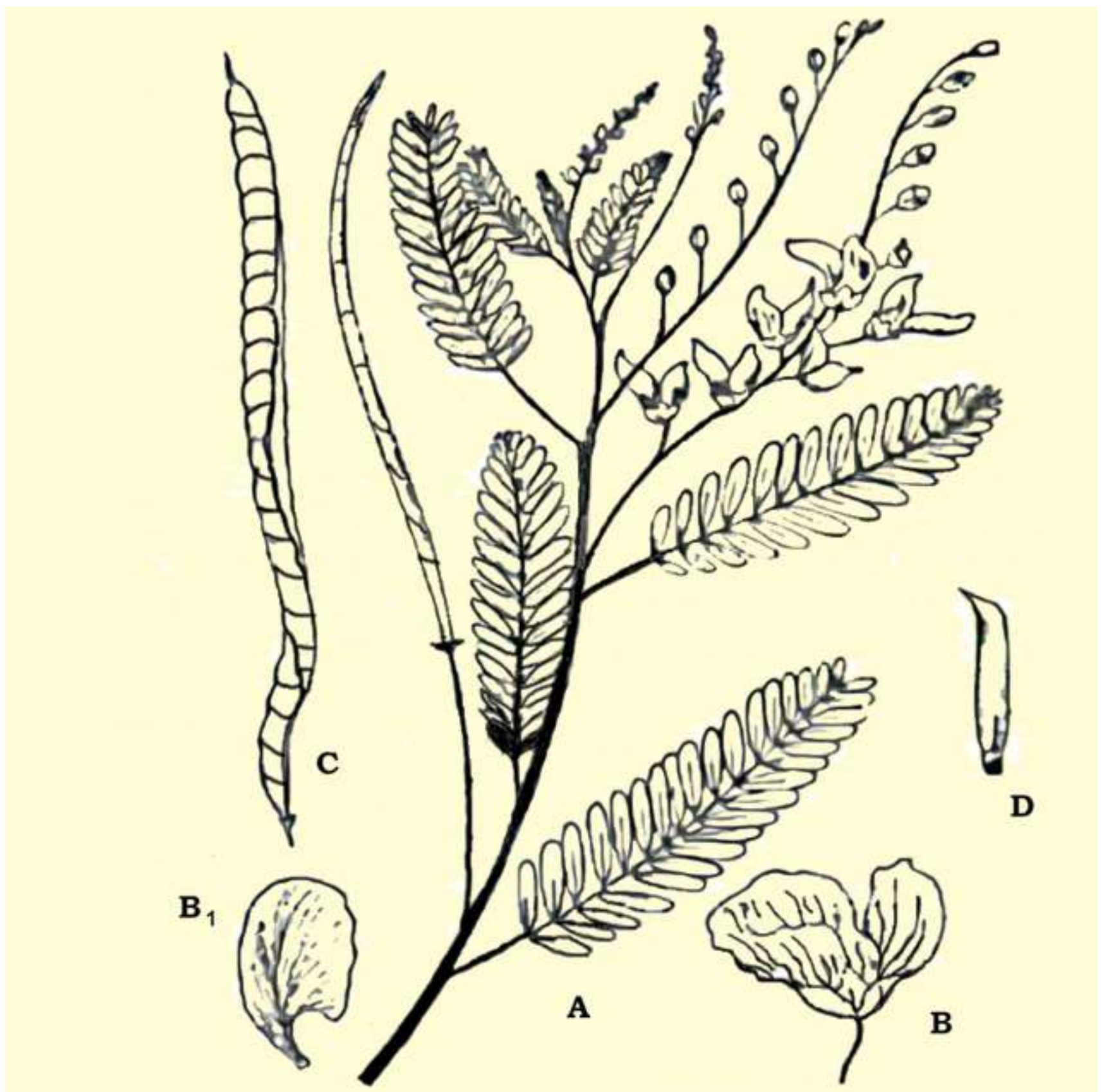

Fig. 9.27 Fabaceae (Papilionaceae): *Sesbania sesbar*; A-twig; B-flower; B1 standard verillum; C-fruit a legume; D-carpel

Floral Characters : **Inflorescence:** Racemose or solitary axillary. **Flowers:** Bisexual, zygomorphic, bracteate, pedicellate, perigynous, pentamerous and papilionaceous. **Calyx:** 5 sepals, more or less united in a tube, mostly hairy. **Corolla:** Papilionaceous; petals 5, usually clawed, dissimilar; the upper posterior petal is large and conspicuous and is called standard or vexillum, 2-lateral ones free called wings and 2 anterior inner most that fuse to form a boat-shaped structure called the keel or carina. **Androecium:** Stamens 10, mostly diadelphous (united by their filaments in 2 groups), 9 fused to form a sheath round the pistil, while 10th posterior one is free. **Gynoecium:** A simple pistil, 1- carpel, with 1-locule; ovary superior; ovary and style long, style bent at its base, **placentation** (mono carpellary) marginal. **Fruit:** Usually a legume or pod, showing a great variety of form in various species.

Economic Importance : The family is of considerable importance as a source of high- protein food, oil, and forage as well as ornamentals and other uses. Main importance lies in the pulses, belonging to this family, which are used as food, some important and common species of pulse yielding plants are: Gram, Pea, Kidney bean. These pulses are rich in protein contents.

Medicago sativa Alfafa is one of the world's best forage crop for horses. *Vicia*, *Melilotus* and *Trifolium* are also cultivated as main fodder crops. Many trees of this family provide excellent timber for building, furniture and fuel. Main timber plants are *Butea*, *Dalbergia* etc.

Seeds of *Arachis hypogea* peanut are edible and also used for extraction of peanut oil which after hydrogenation is used as a vegetable oil. Indigo dyes are obtained from *Indigofera tinctoria* and *Butea monosperma*, yielding yellow dye from flowers.

Many plants of this family are important for medicines: these include *Glycyrrhiza glabra* for cough and cold, and *Clitoria tematea* is used against snake bite. The red and white seeds of *Abrus precatorius* are used by jewellers as weights called "ratti". Some important ornamental plants include *Lathyrus*, *Lupinus*, *Clitoria*, *Butea* etc.

CAESALPINIACEAE: Cassia Family

This family includes about 152 genera and about 2300 species. In Pakistan the family is represented by 16 genera and about 60 species.

Familiar Plants: *Tamarinaus indica*, *Cassia fistula*, *Bauhinia veriegata*.

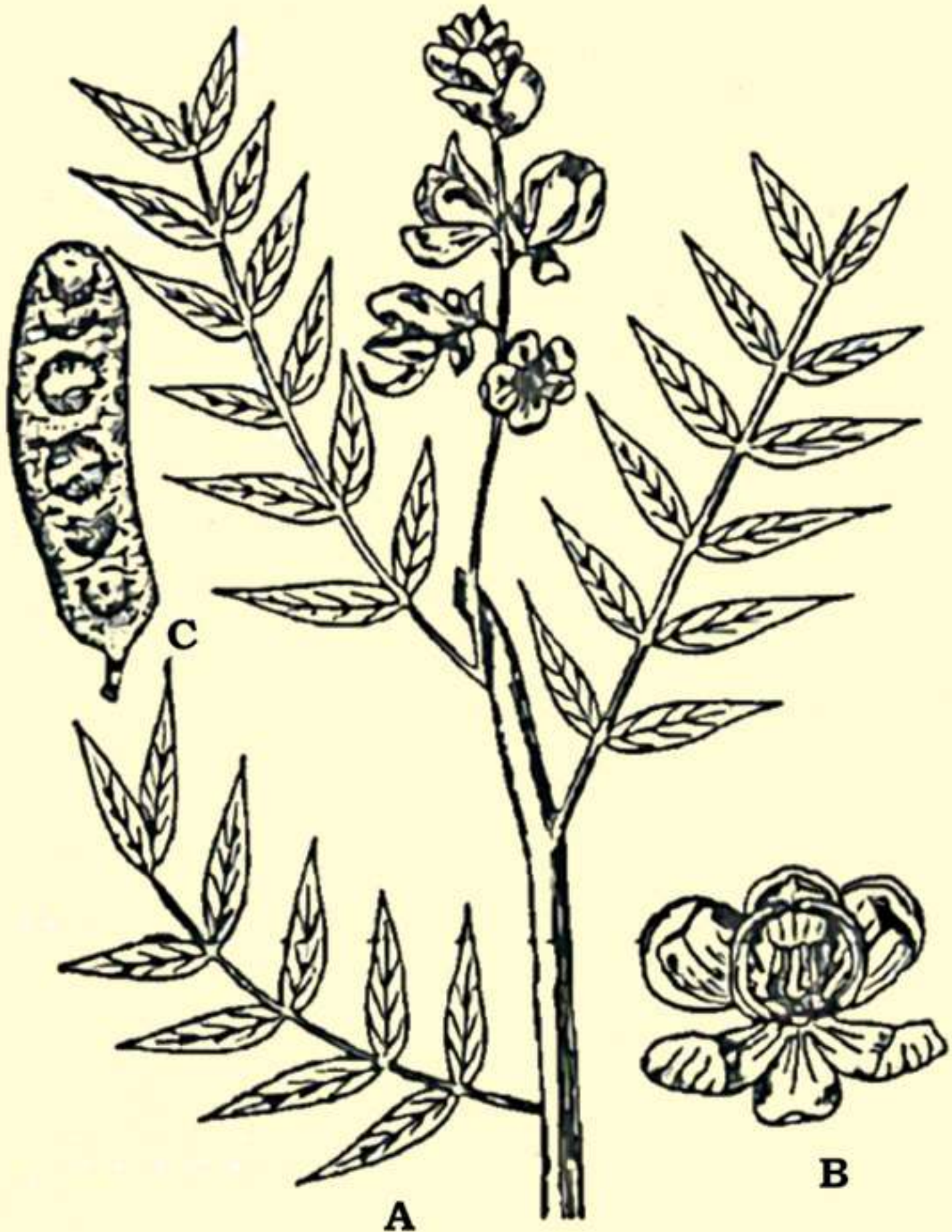

Fig. 9.28 Caesalpiniaceae : *Cassia senna*; A twig, B-flower; C-fruit

Vegetative Characters Habit: Mostly trees or shrubs, some are woody climbers; rarely herbs. Stem: Erect, woody, herbaceous, or climbing. Leaves: Compound, pinnate, very rarely simple, stipulate

Floral Characters : Inflorescence: Axillary or terminal raceme or panicle or spikes, rarely cymose; showy. **Flowers:** Bisexual, zygomorphic, rarely actinomorphic, perigynous. **Calyx:** Sepals 5, free or connate at base, often colored. **Corolla:** Mostly 5 petals, free. **Androecium:** Stamens 10 or fewer, rarely numerous, free or variously united. **Gynoedum:** A simple pistil 1-carpel; ovary superior, unilocular; **placentation** marginal; stigma simple. **Fruit:** Legume

Economic Importance : The family is of great importance. Some plants are ornamental, some have medicinal importance, a few have food and other values.

The leaves of *Cassia alata* are used to cure ring worm and skin diseases. *Cassia senna* and *C. obovata* are cultivated for the leaves which yield the drug Senna, which is the base for a laxative. Oil extracted from the seeds of *Cynometera cauliflora* is applied externally for skin diseases.

Common ornamental plants are *Bauhinia variegata* (Kachnar), *Cassia fistula* (Amaltas), *Parkinsonia*, etc.

The leaves and flower's bud of *Bauhinia variegata* are used as vegetable. The acidic fruit of *Tamarindus indica* are edible and are rich in tartaric acid. The bark of *Bauhinia and Tamarindus indica* is used in tanning. The heartwood of *Haematoxylon* (Longwood) yield the dye Haematoxylin.

MIMOSACEAE: Mimosa or Acacia Family :

A family of about 56 genera and about 2800 species. In Pakistan it is represented by 11 genera and 49 species, of these only 4 genera and 18 species are native and rest are introduced.

Familiar Plants: *Acacia nilotica* , *Albizzia lebbek*, *Mimosa pudica* Touch me not, *Prosopis glandulosa*, *P. cineraria*.

Vegetative Characters : Habit: Mostly trees or shrubs, rarely climbers or herbs. Most of them are xerophytes. Stem: Mostly woody. Leaves: Pinnate by compound, alternate, stipulate, stipules modified into thorns.

Floral Characters : Inflorescence: Spike like or head or umbel, rarely racemose or globose umbels. **Flowers:** Bisexual, Actinomorphic, hypogynous to slightly perigynous, bracteate. **Calyx:** Usually

sepals 5, generally fused, toothed or lobed. **Corolla:** petals 5, free or fused; corolla lobed. **Androecium:** Stamens 5 to numerous, free, or adnate to the base of corolla. **Gynoecium:** A simple pistil of 1 carpel, ovary unilocular, superior; ovules many, placentation marginal. **Fruit:** A legume dehiscent or indehiscent.

Economic Importance : Many trees of this family including species of *Acacia*, *Albizzia* and *Xylocarpus* provide commercially important wood, which is used for construction purpose or for furniture or as a fuel. The wood of *Albizzia lebbek* is used in cabinet work, and railway carriages.

Arabic gum is obtained from *Acacia nilotica* and *A. Senegal*. Katha a dye is obtained from *Acacia catechu*. The tender leaves of *Acacia nilotica* are used as blood purifier.

Some common garden plants grown for their beautiful flowers are *Mimosa pudica* and **Acacia melanoxylon**. A few species of *Prosopis* are planted in the arid zones for breaking the wind pressure.

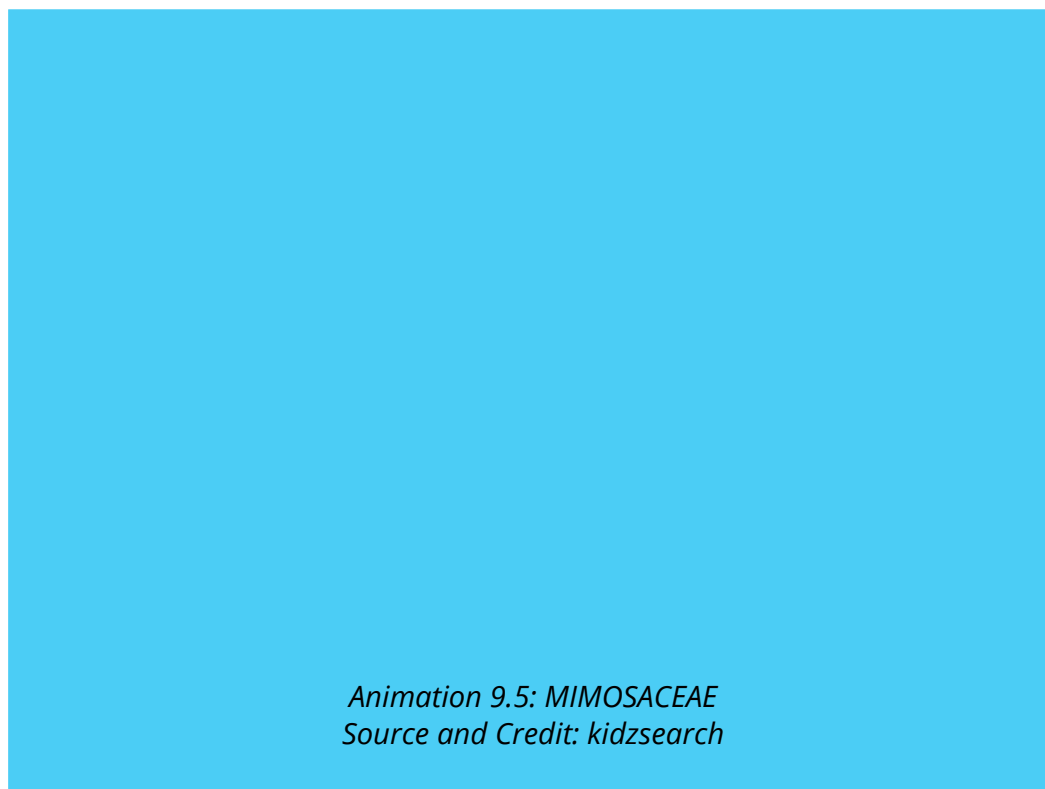

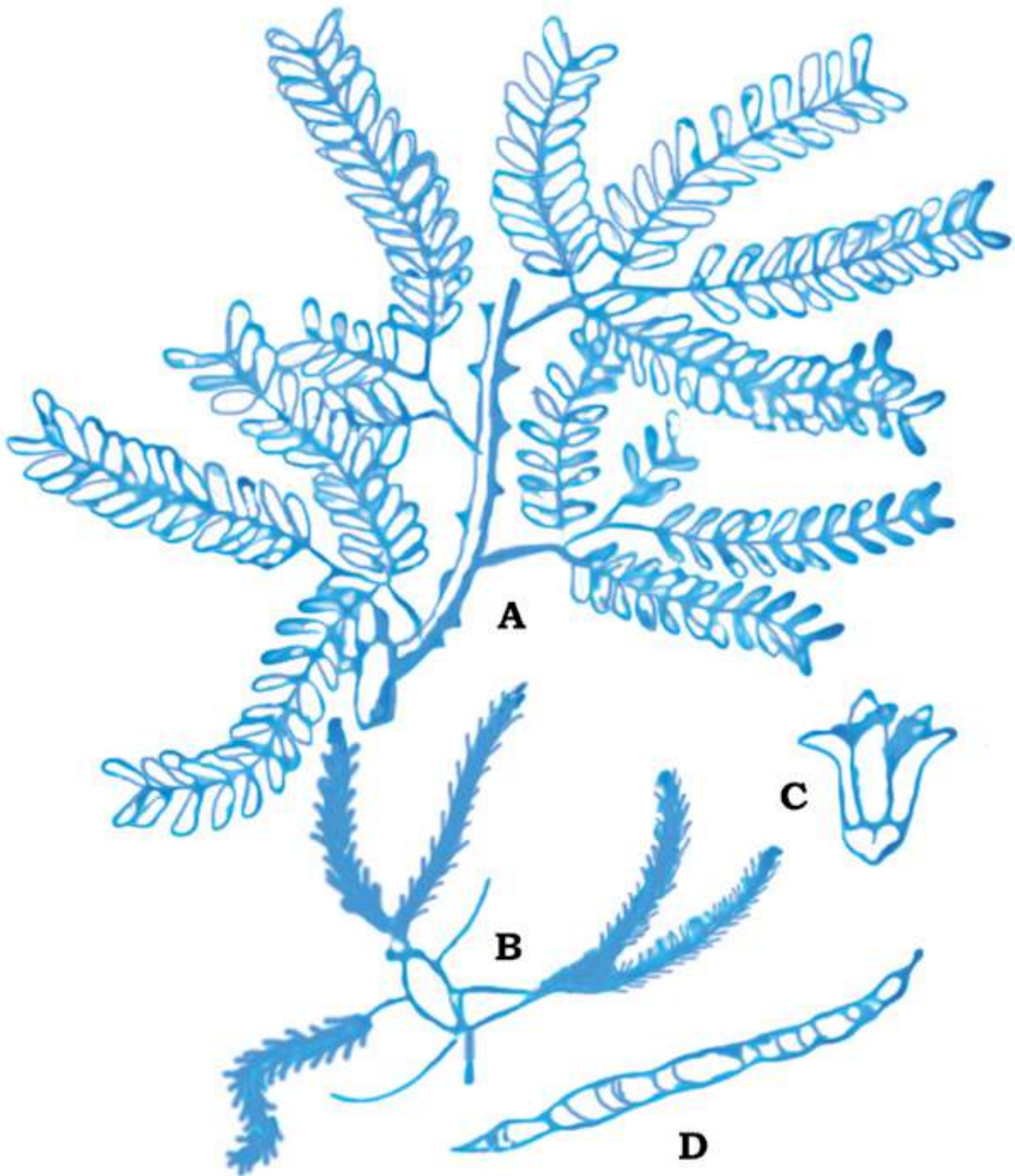

Fig. 9.29 Mimosaceae : *P. rosopsiscineraria*; A-twig, B-inflorescence; C-flower; -D-fruits

POACEAE: (Gramineae) Grass Family

Distributed throughout the world wherever vascular plants can survive. It includes about 600 genera, 10,000 species. In Pakistan it is represented by 158 genera and 492 species.

The traditional family name Gramineae takes its name from the Latin Grammar which was used as a 'generic' name for certain grasses, is permitted by the International Code of Binomial Nomenclature, which also provides for the use of Poaceae, based upon the type genus *Poa* Linn.

Familiar Plants: *Triticum vulgare*, Wheat; *Zea mays*, Corn; *Avena sativa*, Oats; *Oryza sativa*, Rice; *Bambusa*, Bamboo; *Saccharum officinarum* Sugar Cane etc.

Vegetative Characters : Habit: Annual or perennial, herbs. Stem: Jointed usually hollow, at the internodes, closed at the nodes. Leaves: Solitary at the nodes, sometimes crowded at the base of the stem, alternate, exstipulate, ligulate, mostly sessile, leaf-base mostly sheathing, simple.

Inflorescence: Mostly compound composed of units called spikelets which are variously arranged (dense clusters as in wheat, compound spike, or loosely on branched axis-as in oats , spikelets consisting of bracts, arranged along a slender axis (called rachilla) the two lower bracts (called glumes) which are empty; the succeeding lemmas enclosing a flower and opposed by a hyaline scale called palea. The Whole (lemma, palea, and flower) termed as floret; the glumes or lemmas often bearing one or more stiff bristles (called awns); this basic pattern of spikelet structure is consistent throughout the family. Spikelets of grasses vary widely in different genera, particularly as to number of fertile florets in each, and deposition of sexes with them.

Flowers: Usually bisexual, sometimes unisexual, small and inconspicuous, sessile, bracteate, incomplete, zygomorphic, hypogynous. **Perianth:** Absent or represented by 2, (rarely 3), minute hyaline or fleshy scales called lodicules. **Androecium:** Stamens 1 to 6, usually 3. with delicate filaments. **Gynoecium:** A compound pistil of 3 united carpels, anthers versatile, though only one is functional free; stigmas usually large feather like. Fruit : Grains or Caryopsis (caryopsis a dry, indehiscent fruit in which fruit wall (pericarp) is completely fused with seed coat).

Economic Importance : Economically family Poaceae has greater importance than any other family of flowering plants. It has great economic importance to both man and animals. Cereals and millets which constitute the chief food stuff of mankind, belongs to this family. Most of the fodder crops, which are equally important to domestic animals, also belong to this family.

Plants providing food for man includes: *Triticum sp.* (wheat), *Avena sativa* (Oats), *Zea mays* (Corn, Maize), *Oryza sativa* (Rice), *Hordeum vulgare* (Barley), *Secale cereale* (Rye), *Penisetum typhoideum*; *Sorghum vulgare* etc.

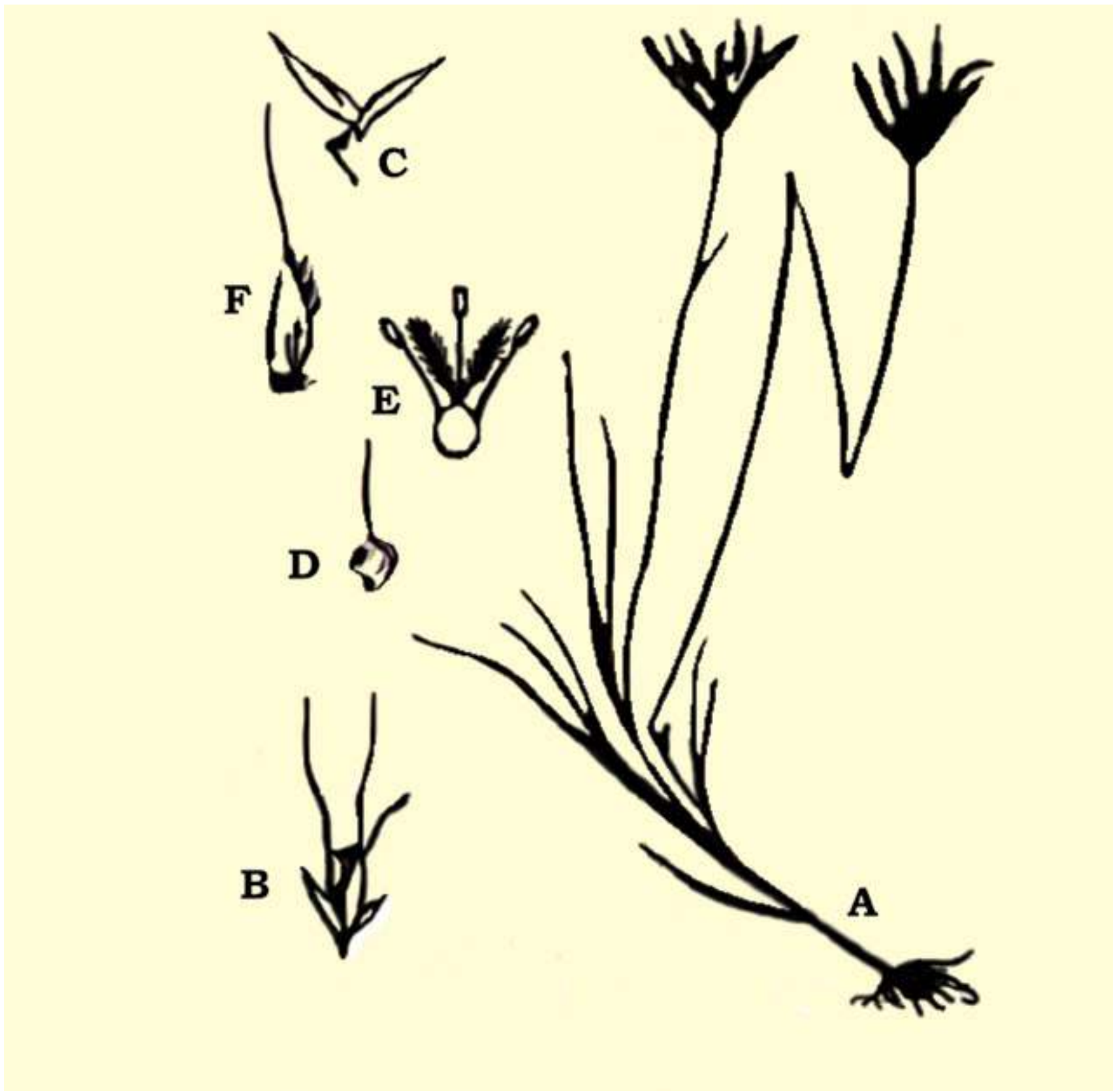

Fig. 9.30 Poaceae (Gramineae): *Chloris barbata*: A habit; B-spikelet; C-glumes; D-fertile lemma, E-flower; F-fruit;

The dried stem and leaves of the cereal crops are used as fodder for the cattle. Sugar is obtained from the juice of *Saccharum officinarum* (Sugar Cane). Many grasses are used in the lawns e.g. *Agrostis*, *Poa*, *Festuca* etc. and have ornamental significance.

Bambusa (Bamboo) are used as building material for the thatching huts, making boats, carts, pipes etc. and the split stem are woven into mats, baskets, fans, hats, coarse umbrella. Leaves are also given to horses as a cure of cough and cold etc. Certain grasses yield aromatic oils, e.g. *Cymbopogon citratus* (lemon grass) which yield lemon grass oil is used in perfumes and soap industry and for making infusions. Some species of the grasses are used in making papers.

Ethyl alcohol and many other kind of beverages are also prepared from cereals for example whisky from Rye, barley, corn and rum molasses from sugar cane. Fibers obtained from the leaves of *Saccharum munja* which is used in making ropes.



Animation 9.7: Poaceae
Source and Credit: next.cc

EXERCISE

Q1. Fill in the blanks.

- (i) The sporophyte is _____ and _____ generation and the gametophyte is _____ and _____ .
- (ii) The motile asexual reproductive cells are characteristics of _____ and are called _____ .
- (iii) The sexual reproduction is said to be oogamous or heterogamous if the two fusing gametes are-----.
- (iv) In the stem of Monocotyledons the bundles are _____ while in the stem of Dicotyledons they are _____ .
- (v) The double fertilization is the characteristic feature of _____.
- (vi) Stem roots and leaves are the _____ parts and flowers, fruits and seeds are the : _____ parts of the plant.
- (vii) _____ is the phenomenon of the production of two kinds of spores in the plants.
- (ix) The naked-seeded plants are included in the group _____.

Q.2 Short questions.

- (i) (a) How are ferns better adapted to life on land than liverworts and mosses?
 (b) Which of the following are nutritionally self supporting:
 1. Mature liverwort and moss gametophyte.
 2. Mature liverwort and moss sporophyte.
- (ii) (a) The chances of survival and development of wind-blown pollen grains are much less than those of spores of Adiantum. Comment on this statement.
 (b) Account for the fact that megaspores are large and microspores are small.
 (c) What important advances have angiosperms made towards the seed plant life?

- (iii) Write a note on the alternation of generations.
- (iv) What is the importance of the following?
 (i) Seed. (ii) Double fertilization.
 (iii) Heterospory.
- (vi) Pick and match the following:
- | | |
|--------------------------------|---|
| (i) Fem sporophyte | involves vegetative parts of plants. |
| (ii) The moss plant | is the first cell of sporophyte. |
| (iii) The gamete | is the last cell of gametophyte. |
| (iv) The spores | are asexual reproductive cells. |
| (v) Vegetative reproduction | are haploid cells. |
| (vi) The oospore is | gametophytic generation. |
| (vii) The gamete | is a diploid generation. |
| (viii) The spore mother cell | is the first cell of gametophytes. |
| (ix) The spore with | naked seeds. |
| (x) Gymnosperms are the plants | divides by reduction division to form haploid spores. |
- (vii) Sketch and label a fertile pinnule and a sporangium of Adiantum.

Q.3 Extensive Questions

- (i) To what does alternation of generations refer in the plants? Define sporophyte and gametophyte. With which stage is an adult animal comparable? How are they reproductively dissimilar?
- (ii) What is a seed? Why is the seed a crucial adaptation to terrestrial life?
- (iii) Describe evolution of leaf and its importance in vascular plants.
- (iv) Discuss evolution of seed and its significance.

- (v) In what way do the flowering plants differ from the rest of the seed plants? What is the stigma? Is fertilization in angiosperms direct or indirect? From what tissue does angiosperm fruit develop?
- (vi) What two classes comprise the angiosperms? How do the two classes structurally differ from one another? Which class derived from the other? Explain.

CHAPTER

10

Kingdom Animalia

Animation 10.1: Growth and development
Source & Credit: Wikispaces

INTRODUCTION

Animalia kingdom includes all the animals. The name animalia is derived from Latin, anima = breath or soul.

In traditional two-kingdom systems, the multicellular animals were referred to broadly as Metazoa to distinguish them from one-celled animals, the Protozoa. In this text book we have followed the five kingdom classification system introduced by Robert Whittaker. In this system of classification the traditional Protozoa belong to kingdom Protocista. Kingdom Animalia consists of all animals which are multicellular, diploid eukaryotic, ingestive heterotrophs and develop from two dissimilar haploid gametes, a large egg and a smaller sperm. In this chapter we will discuss various groups and subgroups with details of the phyla in your curriculum.

Virtually all biologists agree that animals evolved from protoctists; however, which protoctists, when, and in what sort of environments, are questions that are still actively debated.

Table 10.1 The relationship of different phyla discussed in this chapter.

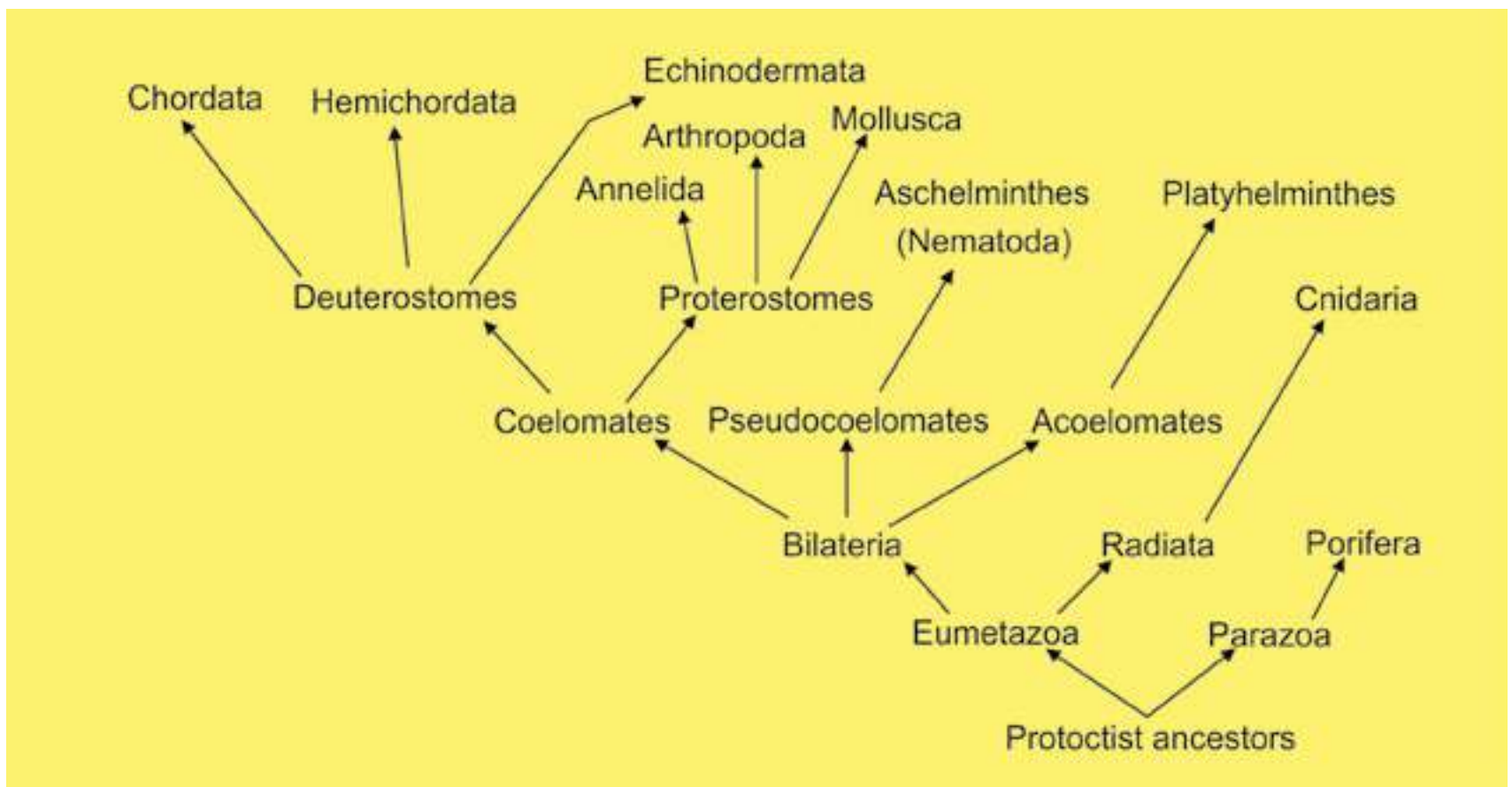

DEVELOPMENT OF COMPLEXITY IN ANIMALS

Although multicellularity is found in all the kingdoms, Fungi, Plantae and Animalia but it has developed most impressively in animals- their cells are joined by complex junctions, this ensures control of communications and flow of materials between cells. The animals are a diverse group distinct in their form. The smallest are microscopic, which are smaller than many protocists and the largest today are whalessea mammals, included in phylum Chordata.

The simplest of the animals belong to subkingdom **Parazoa** (phylum Porifera). These animals lack tissues organised into organs and have indeterminate shape, and are asymmetrical. The subkingdom **Eumetazoa** includes animals of other phyla. These animals have tissues organised into organs and organ systems. These include radially symmetrical animals (grade **Radiata**) and bilaterally symmetrical animals (grade **Bilateria**). Grade Radiata includes simplest of the Eumetazoa (phylum **Cnidaria**). They are much simpler in their organisation compared to the animals belonging to other Eumetazoa. Most of the phyla which belong to kingdom **Animalia** (about 29) belong to subkingdom Eumetazoa. These animals have been divided into three groups on the basis of presence, absence or type of body cavity found in them. The animals which do not have a body cavity have been grouped under **Acoelomata**. The animals which have a false coelom, the **pseudocoele**, have been grouped under **Pseudocoelomata**. The animals which have a true coelom have been grouped under **Coelomata**.

GRADE RADIATA

In this group animals with radial symmetry have been included. All the animals which are included here are also diploblastic. This is a condition or organization in which the parts of the body are arranged around a central axis in such a way that any plane passing through the central axis divides the animal in halves that are almost mirror image of each other e.g. as in cnidaria (coelenterata). The cylindrical body of a sea-anemone can be cut in two equal halves vertically in any plane.

GRADE BILATERIA

This group includes animals with bilateral symmetry. In an animal where the right side is approximately the same as the left side and where there is a distinct anterior end is said to have bilateral symmetry. The animal can be divided into two equal parts by an imaginary line only in one plane. In most multicellular animals there is a clearly differentiated head present at the anterior end and a distinct posterior end. Also there are clearly defined dorsal and ventral surfaces. The animals belonging to phyla, Platyhelminthes, Nematoda, Annelida, Mollusca, Arthropoda, Echinodermata, Hemichordata and Chordata are included in this grade. It must be mentioned here that the animals belonging to phylum echinodermata, have developed bilateral symmetry, as is evident, from the study of structure of their larvae. However, the adult Echinoderms, have secondarily developed radial symmetry, due to their special mode of life. All the animals included in grade Bilateria are triploblastic. These may be acoelomate, pseudocoelomate or coelomate.

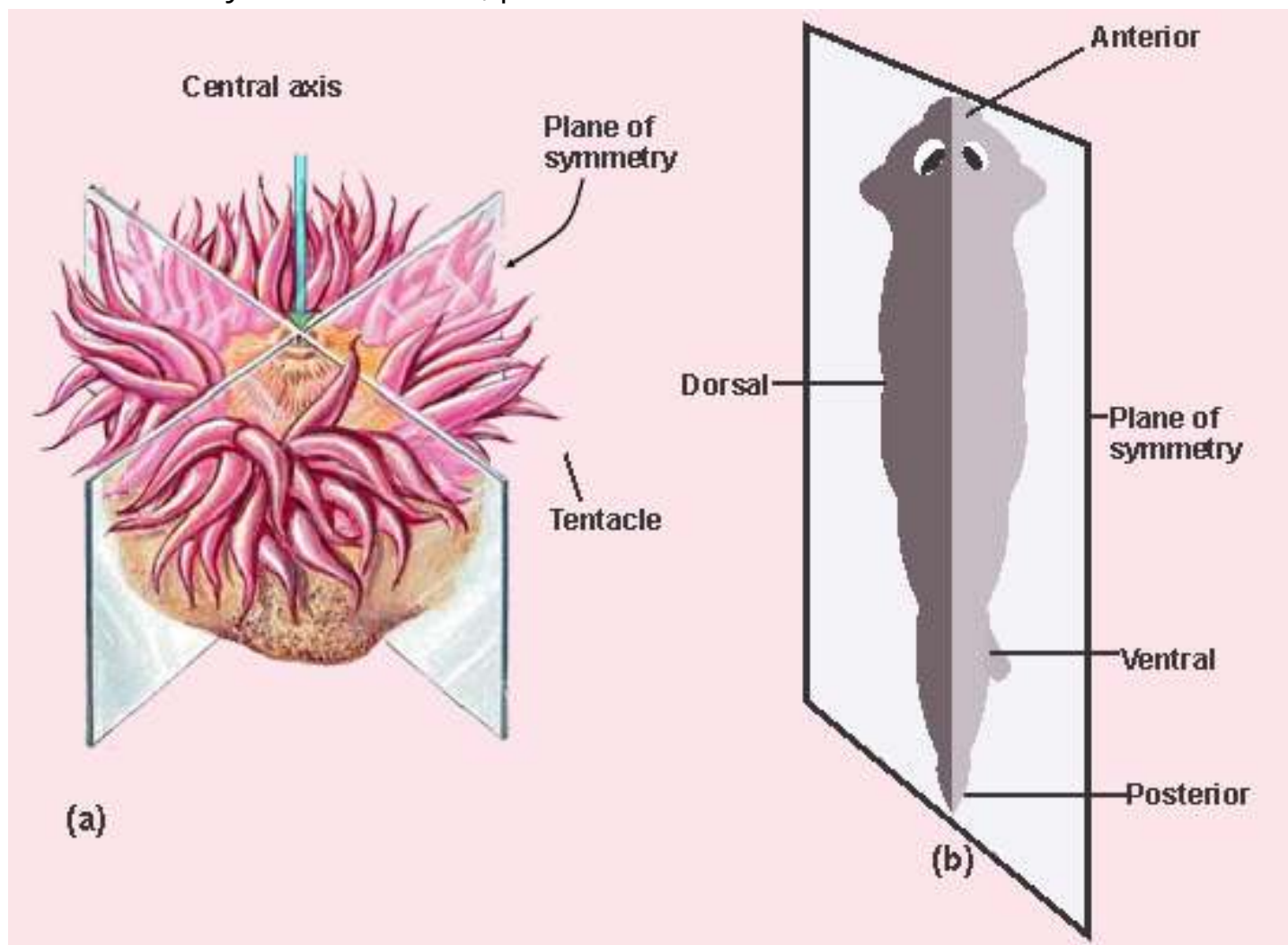

Fig. 10.1 (a) Radial (b) Bilateral symmetry

Series Proterostomia (Protostomes)	Series Deuterostomia: (Deuterostomes)
<ol style="list-style-type: none"> 1. Cleavage or division of the zygote is spiral and determinate. 2. During development process the mouth in these animals arises from the blastopore or from its anterior margin. 3. Coelom or body cavity is formed due to splitting of mesoderm (schizocoelous). 4. Mesoderm is derived from cells on anterior lip of blastopore. 5. This series proterostomia includes animals belonging to phyla aschelminthes (nematoda) annelida, mollusca and arthropoda 	<ol style="list-style-type: none"> 1. Cleavage is radial and indeterminate. 2. During embryonic development mouth is formed at some distance anterior to the blastopore and blastopore forms the anus. 3. Coelom is developed as an outpouching of archenterons (enterocoelous). 4. Mesoderm is derived from wall of developing gut (archenteron). 5. This series includes animals belonging to phyla echinodermata, hemichordata and chordata.

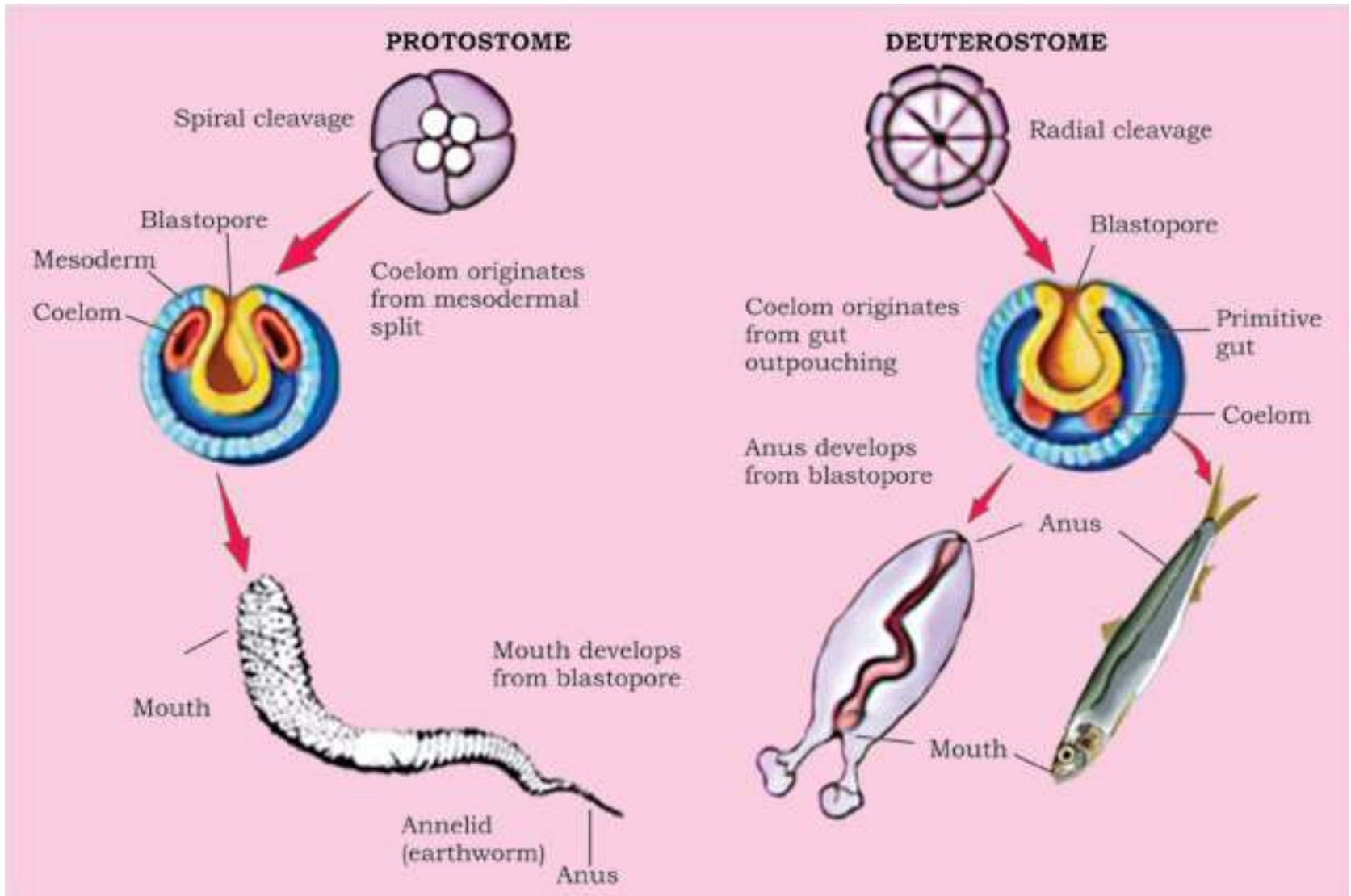

Fig. 10.2 Patterns of embryonic development of coelom and of egg cleavage In protostomes and deuterostomes.

Spiral and determinate cleavage is that in which the lines or planes of cleavage are not symmetrical between poles instead these are diagonal to the polar axis and produce unequal cells around the axis of polarity and all the blastomeres have determined role to play in the formations of embryo. The fate of each blastomere is foretold.

In **radial and indeterminate** cleavage the planes of cleavage are symmetrical to the polar axis and produce tiers of cells on top of each other and the fate of each blastomere is not pre-determined. In some anyone blastomere can produce a complete embryo.

DIPLOBLASTIC AND TRIPLOBLASTIC ORGANISATION

Diploblastic animals belong to division radiata. The body of these animals consists of two layers of cells, ectoderm and endoderm. There is a jelly like mesenchyme or mesogloea which in most cases is non cellular. Diploblastic animals show lesser degree of specialisation and they do not form specialised organs. There is no special transport system in these animals. Most substances are distributed within their body by process of diffusion. There is no central nervous system in these animals. A neuron net is present. These animals have radial symmetry. There is only one cavity in the body called gastrovascular cavity which has only mouth which serves for the entry of food and water and also for the removal of wastes along with water. This is known as sac like digestive system. Diploblastic animals are included in phylum Cnidaria (coelenterate) which would be discussed in detail later in the chapter.

Triploblastic animals are included in phyla which have been placed in grade bilateria/ The body of these animals is made from three layers ectoderm, mesoderm and endoderm. After embryonic development these layers in most triploblastic animals are not distinct as separate layers of cells, but are represented by the structures formed from them. The cells of these animals show greater degree of specialisation. These have specialised organs and organs systems. Special transport systems i.e. blood vascular system is present in most of the cases. The systems such as integumentary and nervous develop from ectoderm. Mesoderm gives rise to muscular, skeletal and reproductive systems. Endoderm forms the lining of digestive tract and glands of digestive system, such as liver. The digestive system is of tube type i.e. having mouth at the anterior end and the anus at the posterior end. Triploblastic animals may be acoelomate, pseudocoelomate or coelomate.

Acoelomates, Pseudocoelomates and Coelomates

The following account would help to explain the above mentioned terms.

Acoelomates

In phylum Platyhelminthes there is no body cavity or coelom, and the mesoderm forms a loose, cellular tissue called mesenchyma or parenchyma which fills the space between the ectoderm and endoderm. It forms a packing around the internal organs of the animals to support and protect them. Such animals are called acoelomates (Fig. 10.3). In acoelomates the gut is sac-type and there is no special transport system. Only excretory system is developed for the transport of excretory products. This system consists of flame cells, excretory ducts and excretory pores. However the nervous system is well developed.

Pseudocoelomates

In Aschelminthes the space between the body wall and the digestive tube is called pseudocoelom (false body cavity). Pseudocoelom is not homologous to true coelom because: it is not lined by coelomic epithelium. It has no relation with the reproductive and excretory organs. It develops from the blastocoel of the embryo and it is bounded externally by the muscles and internally by the cuticle of the intestine. The animals having pseudocoelom are called pseudocoelomates

Coelomates

Coelom is cavity present between the body wall and the alimentary canal and is lined by mesoderm. The mesoderm splits into outer parietal layer which under lines the body wall and the visceral layer which covers the alimentary canal and the cavity between them is the true coelom. It is filled with fluid called **coelomic fluid**. The animals which possess coelom or true body cavity are called coelomates e.g. animals from annelids to chordates.

In coelomates gut attains more complexity and neuro-sensory system is well developed along with excretory system, circulatory system, respiratory and reproductive systems.

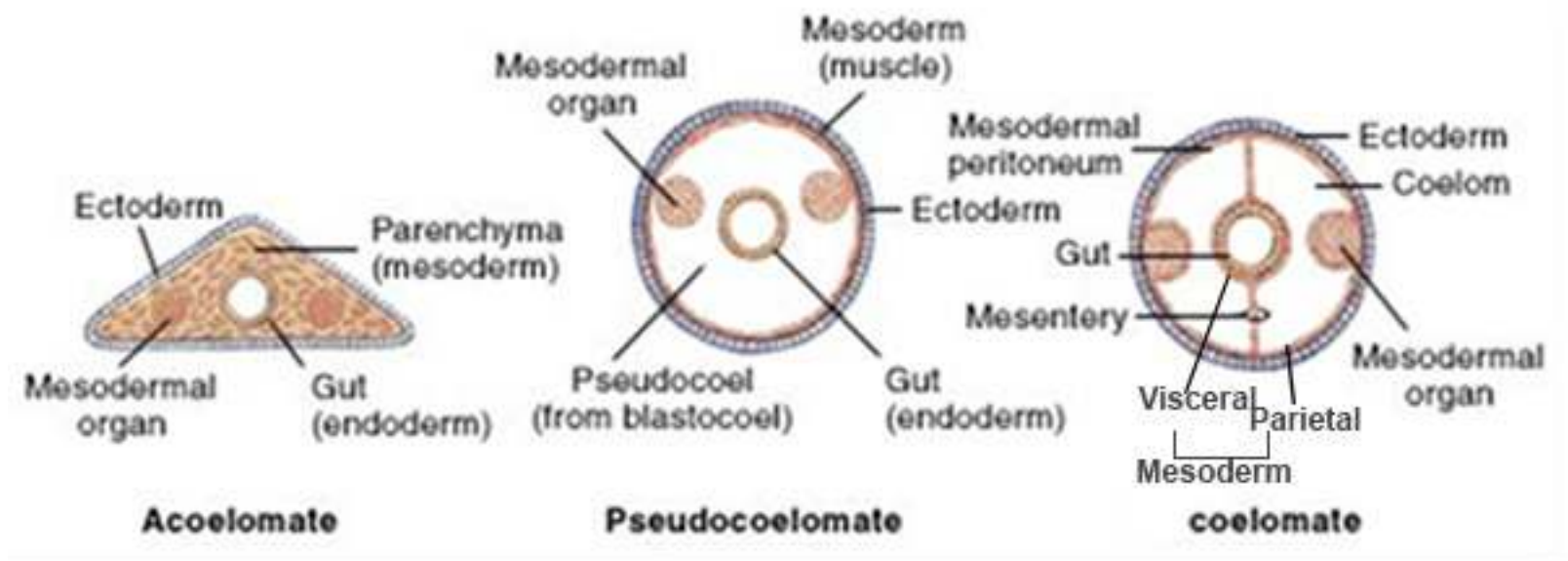

Fig. 10.3 General body plan of acoelomate, pseudocoelomate and coelomate.

PARAZOA

Phylum: Porifera the most primitive animals

The name porifera is derived from Latin *porus* = pore, *ferra* = to bear

The Porifera are pore-bearing animals, commonly called the sponges. All are aquatic. Out of total 5000 species 150 species live in fresh water while all others are marine.

General Characteristics

These animals are composed of many cells however there is no tissue organization and have no organs. Sponges lack symmetry. In most sponges the body wall is formed of an outer layer, pinacoderm, made up of cells called pinacocytes: and an inner layer choanoderm made of flagellated collar cells called choanocytes. Between these two layers is present gelatinous mesenchyme which may contain amoeboid cells and spicules or sponging fibres.

Scolymastra joubini- a barrel like glass sponge of Antarctica is more than a metre tall.

The poriferans range in size from few millimeter wide to more than one metre tall. They are macroscopic i.e., can be seen with naked eye. There is a single cavity inside the body, the **spongocoel**. In most sponges the spongocoel may be divided into flagellated chambers or canals, lined by flagellated choanocytes.

Numerous pores are present in the body wall. The pores through which water enters the body are called **ostia**, and pore by which the water leaves the body is known as osculum (main opening). There are no respiratory or circulatory organs.

Since the sponges are sessile, therefore these depend upon the food coming to them along with water currents brought about by movement of flagella of choanocytes. This includes small animals, (zooplankton) and plants, (phytoplankton) which constitute about 20% of their food. 80% of their food consists of detrital organic particles. The food enters the spongocoel cavity through Ostia. The food is ingested by the flagellated cells, the **choanocytes**. The waste products either diffuse out of the sponge directly through the body wall or flow out through osculum.

The adult sponges are stationary, spending their lives attached to the rocks at the bottom or other solid objects. However, their larvae are able to move (swim).

There is no definite nervous system, however neurosensory and neuron cells are probably present which seem to coordinate the flow of water.

The skeleton is in the form of variously shaped needle-like structures called spicules. These may be calcareous or siliceous. The bath sponge has a skeleton of spongin fibres. The skeleton is present among pinacocytes and provides support. Spicules are also present around osculum and ostia.

Sponges reproduce both by asexual and sexual methods of reproduction.

The **asexual reproduction** in sponges is by **budding**. The buds may be external or internal, The internal buds are called **gemmuies**. Both types of buds develop into new sponges.

Some sponge species reproduce sexually. These are mostly **hermaphrodite**, mostly **protandrous**, i.e. male sex cells develop first. In some sponges the sexes are separate. Sperms released in water are carried to the eggs by amoeboid cells. Fertilization occurs in mesenchyme and zygote is formed. The embryo development includes blastula and larval stages.

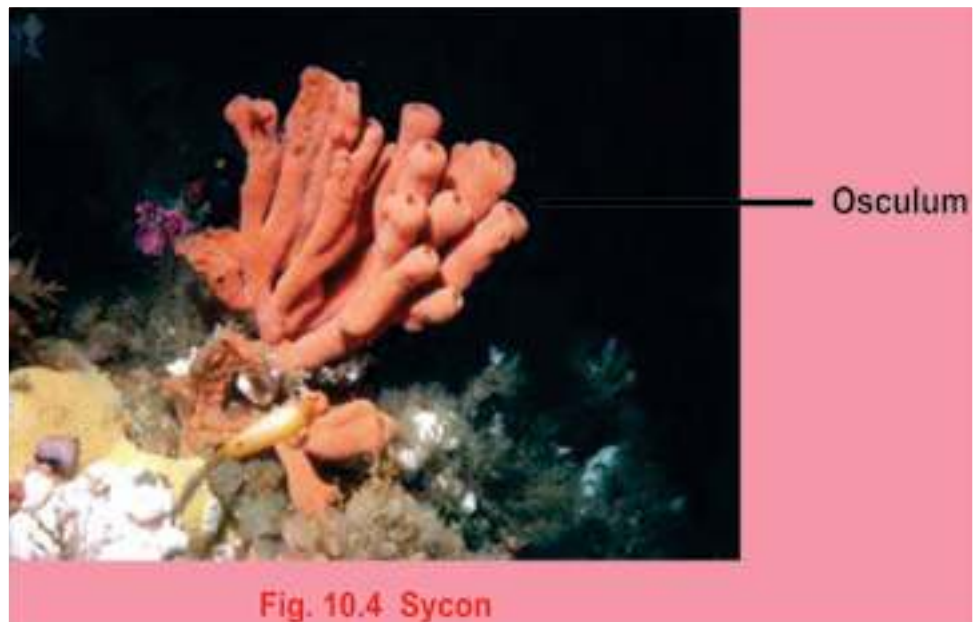

Fig. 10.4 Sycon

Examples of sponges are :

- i. **Sycon:** It is a typical marine sponge.
- ii. **Leucoselenia:** A sponge that consists of group of erect tubes.
- iii. **Euplectella:** It is beautiful and delicate sponge made up of glassy framework. It is commonly called Venus flower basket.
- iv. **Spongilla:** It is freshwater sponge.

Importance

The skeleton of sponges have long been used by man mostly for washing and bathing. Although many artificial sponges have been made from synthetic material, still the natural sponges are in demand and is an important industry in many parts of the world. The best commercial sponges are found in the warm waters of Mediterranean Sea. Sponges have great capacity to absorb water. They are used in surgical operations for absorbing fluids and blood. They are also used for sound absorption in buildings.

GRADE RADIATA

Phylum Coelenterata / Cnidaria - Diploblastic Animals

The name Cnidaria has been given to this group of animals due to the presence of special cells called **cnidocytes**. These cells give rise to **nematocysts**-the stinging cells, characteristic of this group.

Cnidarians have double layer organization and are therefore diploblastic having tissue grade organization and have organs. During the development two germinal layers are formed the outer ectoderm and inner endoderm from which their bodies are constructed. The ectoderm forms outer covering and some cells of this layer in most animals give rise to nematocysts while the endoderm cells become specialized for digestion of food. Between the two layers is a jelly-like mesoglea. In these animals there is only one cavity which serves as digestive as well as body cavity which is called **gastrovascular cavity or enteron** and opens to the outside by only one opening the mouth. So the animals of this group have sac like digestive cavity.

In coelenterates the arrangement of body parts is in relation to centralized axis (symmetrical). An object is symmetrical where there is a correspondence in form and arrangement of parts so that a plane passing through the center divides it into similar halves. The coelenterates have radial symmetry and are aquatic, found both in marine and freshwater habitats.

The coelenterates range in size from microscopic *Hydra* to macroscopic, Branchioceranthus, a hydrozoan polyp that may reach two metres in length. Cnidarians are found in two basic forms the **polyps** and the **medusae**. Polyps are cylindrical animals, which in most cases are nutritive in function, hence named as **gastrozooids**. The medusae are umbrella like in form. These are free swimming. The medusae are involved in sexual reproduction as they have gonads.

The mouth is surrounded by a series of tentacles. These bear stinging cells or nematocysts, which are organs of defense and offense.

The coelenterates are carnivores and feed upon small organisms which come into contact with them. These organisms are immobilized by nematocysts and taken into the digestive cavity as food where it is digested and then distributed by diffusion.

The nervous system is in the form of a network of neuron cells forming an irregular net or plexus in the body-wall. There is no central nervous system.

Many colonial coelenterates such as corals produce a hard exoskeleton formed of calcium carbonate

(CaCO₃). It is secreted by epidermal cells that take lime from sea water. The skeleton of coral is responsible for formation of small coral islands or large coral reefs.

Most species are sessile, for example *Hydra*, *Obelia*, sea-anemone and corals, while other are free living and motile e.g. jelly fishes etc. Many live as solitary individuals e.g. *Hydra* jelly fishes and sea-anemones and quite a large number are colonial e.g. physalia, vellela etc. A colony is an aggregation of individuals or zooids that perform different functions for the colony.

In Coelenterates reproduction takes place by asexual as well as sexual means e.g. *Hydra* reproduces asexually by the formation of buds on its surface. The bud after some time separate from the parent and develops into a new individual. In *Obelia* for example there is asexual as well as sexual reproduction. It has a kind of zooid known as blastostyle which gives rise to individual zooids called medusae by asexual method. The medusae when released in water develop reproductive organs which produce gametes that unite to form zygote from which *Obelia* colony is again formed.

The life cycle of coelenterates is characterized by the presence of alternation of generations. There are two generations, one reproduces by sexual means and the other by asexual means. Both generations are diploid. Often the two generations consist of one free-living and one attached stage. Therefore asexual generation and sexual generation alternate with one another. This is known as alternation of generations e.g., *Obelia*.

Some of colonial members have upto five different types of zooids, performing different functions for the colony e.g. Physalia (portuguese man of war).

Polymorphism - A Characteristic Feature of Coelenterates (Cnidaria)

The occurrence of structurally and functionally more than two different types of individuals, called the zooids within the same organism is called **polymorphism**.

For example, in *Obelia* there are feeding individuals, the gastrozooids; the individuals capable of asexual reproduction only, the gonozooids, blastostyles and free-living or sexually reproducing individuals, the medusae..

The common examples of coelenterates are:

- i. **Hydra** : A freshwater - coelenterate. It exists only in polyp form, therefore alternation of generations is absent.

ii. **Obelia** : A marine colonial that exhibits alternation of generations.

iii. **Aurelia** (jelly fish) : The polyp is reduced and medusa is dominant in jellyfish.

iv. **Actinia** (sea anemone) : The body consists of polyp only, enteron is divided by large partitions called mesenteries.

v. **Madrepora** : The body is covered with hard calcareous skeleton formed of calcium carbonate. They are commonly called **corals**. The skeleton forms large coral reefs and even small islands.

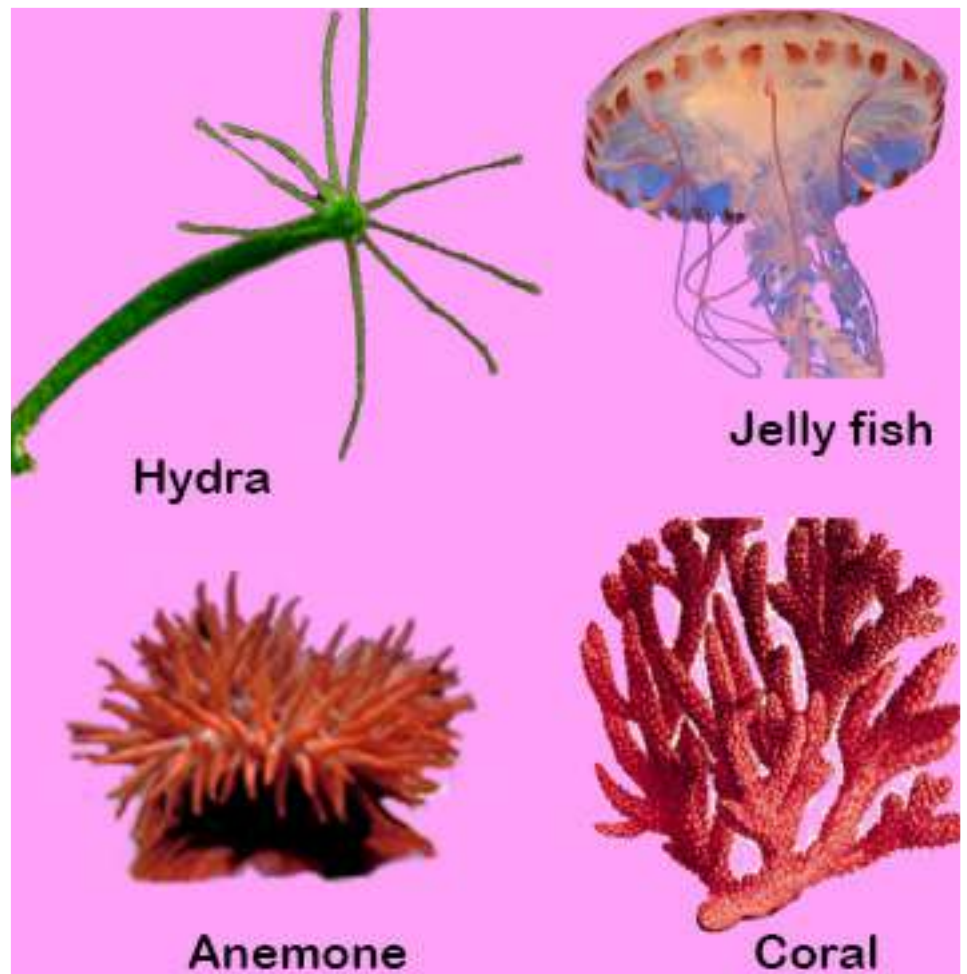

Fig. 10.5 Coelenterates (Cnidarians)

Coral reefs

Corals are formed from the secretions produced by specialized polyps that are present in certain coelenterates. These polyps become covered by stony cups due to hardening of their secretions. From the mouth of the stony cup a polyp can pass out its tentacle for the purpose of feeding and withdraw itself where not feeding. Most such Coelenterates are colonial. The stony network or mass of such Coelenterates are called Corals. Living polyps are found on the surface layer of corals whereas underneath the mass are dead stony structures only and there are no polyps inside. The stony masses that are formed in this way are called **coral reefs**. These are mostly formed of calcium carbonates (lime-stone).

The corals because of their massive structure serve as living place for a variety of sea life.

Coral reefs are found in the coastal waters of Florida, West Indies, East Coast of Africa, Australia and Island of Coral Sea.

GRADE - BILATERIA

Triploblastic animals -The Acoelomates

Phylum: Platyhelminthes -The Flatworms

General Characteristics

The name Platyhelminthes means “flatworms”. The body of these animals is soft and dorsoventrally compressed.

The Platyhelminthes are triploblastic acoelomates. There is development of a third layer, the mesoderm, which separates the ectoderm and endoderm. The Platyhelminthes exhibit bilateral symmetry, and body is unsegmented.

With few exceptions the Platyhelminthes are parasites, mostly endoparasites, i.e., live inside their hosts. The most common examples are *Taenia solium* (tapeworm), *Fasciola hepatica* (liver fluke) and *Schistosoma* (blood fluke). The parasites are more common in tropics. Some of these cause diseases in humans. A few species are free living and found in freshwater, for example *Dugesia* (planaria).

Their size ranges from few millimeters (10 mm in case of Planaria) to several meters (tapeworm).

Much of the body space is taken up by a branching sac type digestive system. The digestive system is poorly developed in some species or may be absent as in the tape-worms.

The excretory system consists of branching tubes ending in bulb-like cells, the **flame cells**.

A well developed nervous system is present in Platyhelminthes. It is in the form of either a simple network of nerves or ganglia. The sense organs are present at the anterior end. Respiratory and circulatory systems are absent.

The parasitic species absorb nutrients from the hosts. The free-living species (Planaria) feed on small animals and bodies of dead and decaying animals.

The free-living forms are motile. They move by cilia present on their undersides (Planaria). In parasitic forms the movement is restricted.

The Platyhelminthes reproduce both by sexual and asexual means of reproduction. Asexual reproduction is by fission in which the animal constricts in the middle into two pieces, each of which regenerates the missing part. The sexually reproducing species are **hermaphrodite**, i.e., both male and female reproductive organs are present in the same individual. Larval form is sometimes present.

The common examples of flatworms are:

(i) **Dugesia (Planaria)** : A free-living flatworms with a ciliated outer surface.

(ii) **Fasciola (Liver fluke)** : It is an endoparasite in sheep and occasionally in human beings. It has suckers used for attachment to host tissue. It completes its life cycle in two hosts, a snail, sheep or man. It lives in the bile duct of its hosts.

(iii) **Taenia (Tape worm)** : An endoparasite of humans, cattle and pig, that completes its life cycle in two hosts. The intermediate host is pig or cattle. The body is ribbon-like and divided into segments called proglottids which contain mainly sex organs. The segments continue to break off and are passed out from the intestine along with faeces.

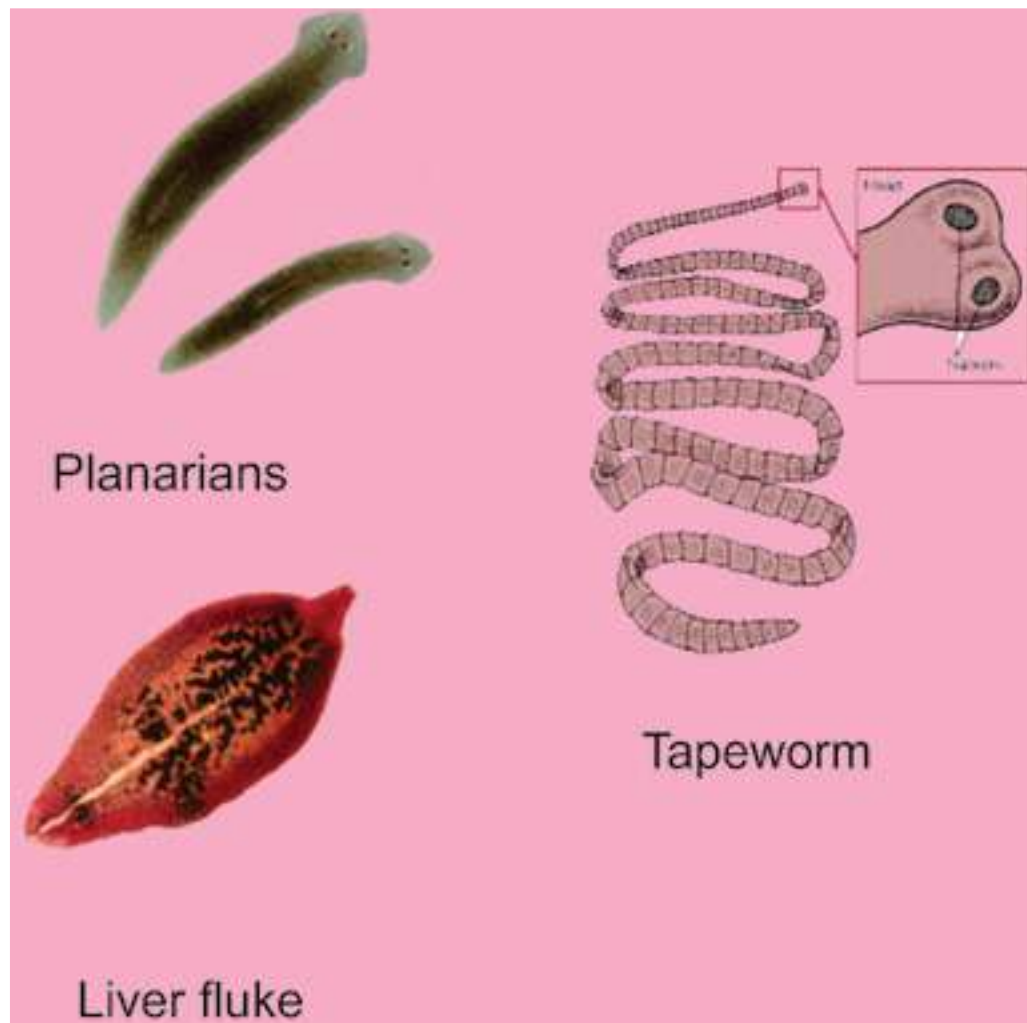

Fig. 10.6 Example of animals of platyhelminthes.

Adaptations for parasitic mode of life

The parasitic Platyhelminthes have completely adapted themselves to parasitic mode of life by the development of the following characteristics:

1. The epidermis is absent and there is the formation of resistant cuticle for protection.
2. They have developed adhesive organs, such as suckers and hooks, for attachment to the host.
3. There is degeneration of muscular system and nervous system.
4. The digestive system has become simplified due to increased dependence on host.
5. The reproductive systems are complicated and the ova are produced in huge numbers to ensure continuity of the species.
6. The complexity of life cycle and presence of more than one host during the life cycle is also an important parasitic adaptation.

Infestation

In Taenia (tape worm), the development of the zygote begins while it is still inside the uterus of female. The last segments or proglottids and their uteri contain completely developed embryo. The fully mature proglottids break off from the body and pass out of the body of man along with faeces (undigested waste). The embryo inside the egg is round in shape and has six chitinous hooks. It shows limited movement of contraction. In order to develop further it must reach a second host which may be a cow. The parasite remains embedded in the voluntary muscles of cow. If an improperly cooked beef is eaten by a person, the parasite which has not been killed begins to develop further in the intestine of man.

Disinfestation

Once the parasite has entered the intestine of man it is difficult to remove it completely. In this respect care should be taken to cook beef properly before eating it. So that there is no chance of the parasite entering the digestive system but if it has entered then certain medicines are taken to remove it. Its complete removal is necessary because if only head remains inside the intestine it can grow into new tape-worm once again. Besides treatment with drugs, physicians also give anema to the patient, to fully remove the parasite.

Triploblastic Animals - Pseudocoelomates

Aschelminthes (Phylum Nematoda) - The Round worms

General Characteristics

The name Nematoda means “pointed ends”. The animals included in this group have elongated worm like body with pointed ends. The nematodes are triploblastic and pseudocoelomates. One end of the body is anterior, however the head is not clearly marked and there are no special sense organs at this end. The nematodes exhibit bilateral symmetry and the body is unsegmented. The body cavity is **pseudocoelom**. It is derived from the hollow space, the **blastocoel**, situated in the **blastula**, an early stage in embryological development, and not from the mesoderm. It consists of a number of vacuolated cells filled with a protein-rich fluid which develops high hydrostatic pressure.

The nematodes range from small microscopic forms, to some form reaching a length of upto one metre. The digestive system is in the form of alimentary canal with two openings. The opening at the anterior end is mouth and at the posterior end is the anus. In parasitic nematodes the digestive system is simple. A fluid filled space is present between the body wall and alimentary canal. It provides “tube within tube” type structure in nematodes. The excretory system consists of

two longitudinally running excretory canals which unite at the anterior end to form a single canal that opens to the exterior through an excretory pore on the ventral surface. There is a nerve ring around the pharynx, which give rise to dorsal, ventral and lateral nerve cords running throughout the length of the worms. The sense organs are in the form of sensory **papillae** present on the lips at the anterior end. The circulatory and respiratory systems are absent. The gaseous exchange takes place through general body surface. Locomotion is by undulating waves of contraction and relaxation of muscles. These muscles are arranged in four bands, two dorso-lateral and two ventro-lateral. The circular muscles are absent, therefore the bending is dorso-ventral only.

The sexes are separate. The female gonads are ovaries and these produce eggs. These male gonads are testes which produce sperms. A larval stage is present in the life cycle.

Importance - Parasitic Diseases

Aschelminthes is important from the point of view of its parasites of which it has a great variety causing some very serious diseases in man and plants.

Ascaris lumbricoides is an intestinal parasite of man.

The genus *Rhabditis* contains numerous species normally found in soil, organic matter or water and feces of man or animals. ***Enterobius vermicularis*** commonly known as pin worm is cosmopolitan but more common in Europe and America. Pinworms are parasites in the human caecum, colon and appendix. Their movement causes intense itching of anus, inflammation of mucous membrane of colon and appendix resulting in insomnia and loss of appetite.

Round worms are everywhere outdoors, where they play an important role in breaking down organic matter. A single rotting apple may contain 90,000 worms. Billions thrive in each acre of topsoil.

Ancylostoma duodenale is commonly known as hook worm. It is a parasite of human small intestine in Asia, North Africa and Europe. It is very dangerous because it holds the villi of intestine and sucks blood and body fluid. During feeding they produce an anticoagulant to prevent clotting of blood and after feeding leave the wound bleeding. In children it can cause severe anemia and retard physical and mental growth.

Triploblastic Animals - Coelomates

Phylum Annelida The Segmented Worms

General Characteristics

Most of the worms with which we are familiar are included in this phylum. They are segmented and commonly called annelids, (from the Latin word for “ little ring”)

The body is metamerically segmented. The body becomes divided transversely into a number of similar parts or segments. The subdivisions may be indicated externally by constrictions of the body surface. Internally, the segments are separated from each other by septa extending across the coelom. However, the various systems of body such as gut, blood vessels, and nerve cord are continuous throughout the length of body penetrating each individual segment.

The animals are triploblastic and coelomate, showing bilateral symmetry. The annelids include worms, which may be marine (*Nereis*), freshwater (*stylaria*) or found in damp soil (*earthworms*). Some are parasites, for example, *Hirudo* - (leech).

The annelids show specialization of body structures. The organ systems are well developed.

Digestive system is in the form of alimentary canal which is divided into distinct parts, each performing a specific function. It has two openings, the mouth at the anterior end, and the anus at the posterior end. The mouth is overhung by a lobed structure, the **prostomium**. In parasitic species, the digestive system is poorly developed.

Annelids have true coelom i.e. the mesoderm splits into parietal layer which lines the body wall, and the visceral layer which covers the alimentary canal, the space between the two layers of mesoderm, is the coelom, and is filled in by coelomic fluid, which serves- as hydrostatic skeleton also.

Excretion takes place by specialized structures called **nephridia**. These are ciliated organs present in each segment in the body cavity.

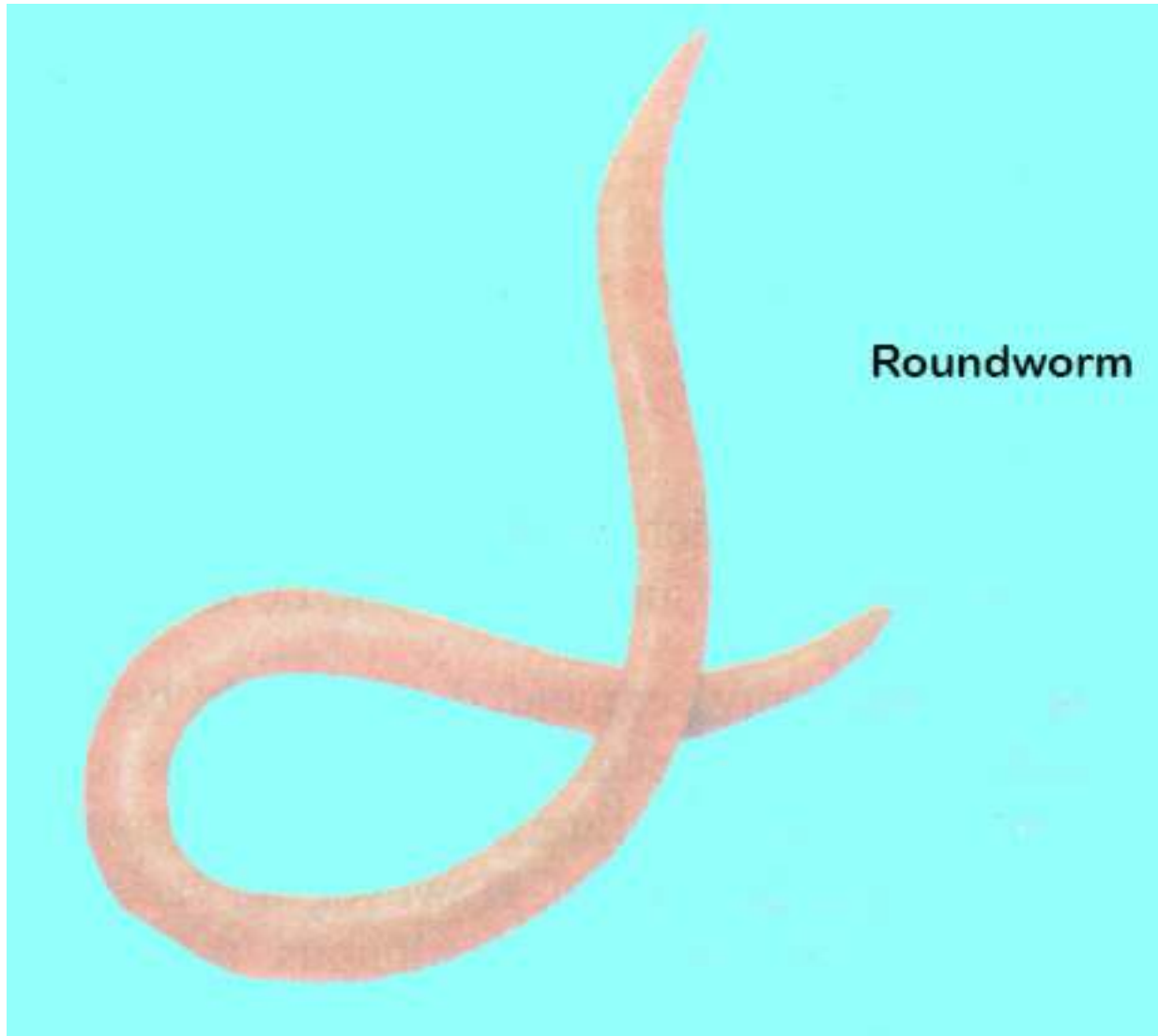

A well developed central nervous system is present in annelids. It comprises of a simple brain and a solid double, longitudinal, ventral nerve cord. Nerves arise in each segment from the nerve cord.

Annelids are the first group of invertebrates which have developed a closed circulatory system - a system in which a circulatory fluid called blood flows in a network of vessels known as blood vessels. It transports gases and nutrients.

The respiratory system is absent. The exchange of gases is by diffusion through the skin in to blood capillaries. The skin is kept moist by ,mucus, and coelomic fluid.

The body wall contains muscles which help in locomotion. The muscles are of two types:

- a. **Circular Muscles** : These are arranged along the circumference of the body.
- b. **Longitudinal Muscles** : These are arranged along the length of the body.

The locomotion is brought about by the interaction of muscles and hydrostatic skeleton. Contraction of circular muscle produces a pressure in the coelomic fluid that forces the body to elongate. Similarly contraction of longitudinal muscles produce a pressure in the coelomic fluid that would cause the body to widen. The organs of locomotion in annelids are chitinous chaetae or setae embedded in sacs (earthworm) or on . parapodia present in the body wall (e.g., *Nereis*). Chaetae are absent in leech.

The common mode of reproduction is sexual. Most annelids (Earthworm, leech) are hermaphrodite. In some annelids (e.g., *Nereis*) the sexes are separate, the fertilization is external and a free swimming **trochophore larva** is produced during the life cycle.

Burrowing activity of earthworms permits greater penetration of air into the soil, and improves drainage capacity of the soil. It also enables roots to grow downwards through the soil more easily. Mixing and churning of the soil is brought about when earth which contains inorganic particles is brought up to the surface from lower regions. Earthworm is perhaps most active segmented worm in churning the soil, therefore it is commonly termed as natural plough.

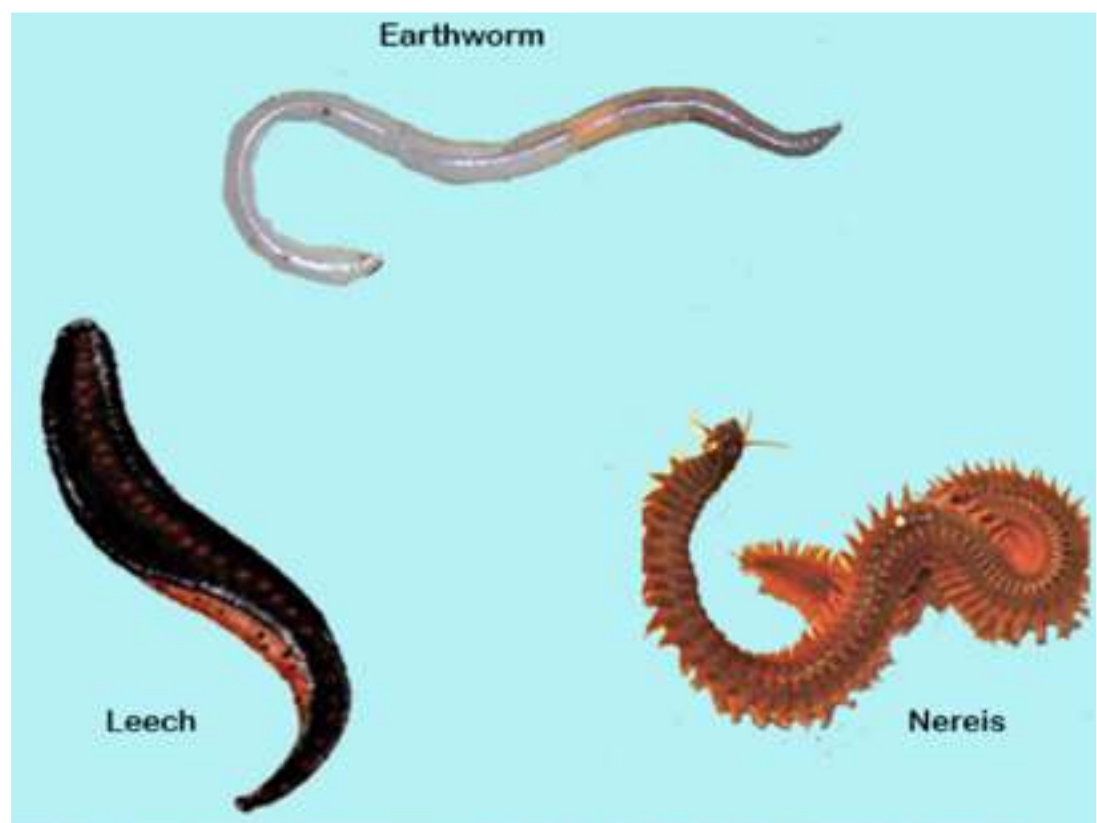

Fig. 10.7 Examples of animals belonging to phylum annelida

Phylum Annelida comprises :

1. Class Polychaeta
2. Class Oligochaeta
3. Class Hirudinea

Class Polychaeta

These have a distinct head region with eyes and structure known as **palps** and **tentacles**. Sexes are usually separate. The organs of locomotion are parapodia. They are mostly aquatic (marine). During development these give rise to a trochophore larva. Important examples are ***Nereis***, ***Chaetopterus***.

Class Oligochaeta

These animals have internal and external segmentation. Organs of locomotion are **setae**. Head region not prominent or distinct. They are hermaphrodite (bisexual). No larva formed during development e.g. *Lumbricus terrestris*, *Pheretima posthuma* and other earthworms. They may be terrestrial or aquatic.

Class Hirudinea

They have body with fixed number of segments. Each segment has additional circular rings or markings called **annuli**. **They do not have organs of locomotion and** move due to the contraction of their body and with the help of suckers. Mostly hermaphrodite and trochophore larva is formed during development. They are aquatic. No distinct head is present but leeches have chitinous jaws for making a puncture in the skin of the host. They also have an anticoagulant secretion which is passed into the wound to allow smooth flow of blood into its digestive system where it can be stored for a long time e.g. *Hirudo medicinalis* (medicinal leech).

Phylum : Arthropods - Animals with Jointed Legs

General Characteristics

The phylum contains more species than any other phylum. They are commonly called Arthropods (arthron = joint + pods = feet). Insects (cockroaches, grasshoppers, butterflies, mosquitoes) are most common arthropods on the earth.

The body is segmented. Each segment is attached to its neighbour by means of a modified portion of cuticle which is thin and flexible. They possess jointed appendages. These appendages have been modified for specialized functions.

These are believed to have common origin with annelids because both have some common characteristics such as segmented body, appendages and cuticle.

Arthropods have exploited every type of habitat on land and in water. The aquatic species include both freshwater and marine. Many of these can fly, therefore visit air periodically.

Arthropods are variable structurally. Some are worm-like centipedes while the others are flying insects with the body divided into distinct regions, the head, thorax and abdomen. The body is covered with waterproof chitinous cuticle secreted by the epidermis.

The coelom is not present as the main body cavity. Instead a haemocoel has developed. It is reduced coelom and communicates with blood vascular system.

The digestive system is in the form of alimentary canal with two openings, the mouth and anus. It is divided into different parts each performing a specific function. The food comprises of small plants and animals.

A well developed excretory system comprising of Malpighian tubules is present in arthropods. The nitrogenous wastes are excreted in the form of solid uric acid.

A highly developed nervous system is present. It consists of paired ganglia (simple brain) connected to a ventral double nerve cord. A ganglion is present in each segment. Nerves arise from these ganglia. The sensory organs are usually a pair of compound eyes and antennae etc.

Most arthropods possess an extensive tracheal system formed of air tubes called tracheae for the exchange of gases. Main tubes open to the exterior through paired openings, called spiracles. Aquatic arthropods respire through gills and book lungs.

The blood circulatory system in arthropods is unique. It is open circulatory system. The blood flows in the body cavity bathing the tissues of the body. However, there is a primitive heart and a main blood vessel situated dorsally. Blood is colourless as it is without haemoglobin.

The skeleton is external, i.e., exoskeleton. It is in the form of an outer covering, the cuticle which is light in weight; and is formed chiefly of chitin. It provides surface for the attachment of muscles which help in locomotion.

The arthropods exhibit active and swift movements. They swim, crawl or fly depending upon the habitat they occupy. The organs of locomotion are paired appendages and in some cases paired wings also.

Reproduction and Life History

The sexes are separate. The testes and ovaries, produce sperm's, and eggs respectively.

Metamorphosis

Life history of insects is characterized by metamorphosis (meta = change + morphe = form). This is an abrupt change of form or structure during the life cycle. There are three morphologically distinct stages in the life cycle, the egg "*finally*" develops into larva which is converted into motionless pupa that finally develops into an adult. In some primitive insects the metamorphosis is incomplete. The larva resembles adult and is called nymph or instar. It lives in the same habitat as adult.

Classification

Phylum Arthropoda is a large group consisting of great variety among them. Some of its important classes are as follows.

1. Class Crustacea : These arthropods are aquatic and have gills for respiration. On the dorsal side of the cephalothorax the exoskeleton is in the form of carapace. In the exoskeleton deposition of salts in addition to chitin makes it more firm. The appendages are modified for capturing food, walking, swimming, respiration and reproduction. Coelom is reduced and is in the form of hemocoel. Head has two pairs of antennal appendages, one pair of mandibles (jaws) and two pairs of maxillae. Sexes are mostly separate e.g. *Daphnia*, *Cyclops*, Crabs, lobsters, prawn, wood louse etc. (Fig. 10.8)

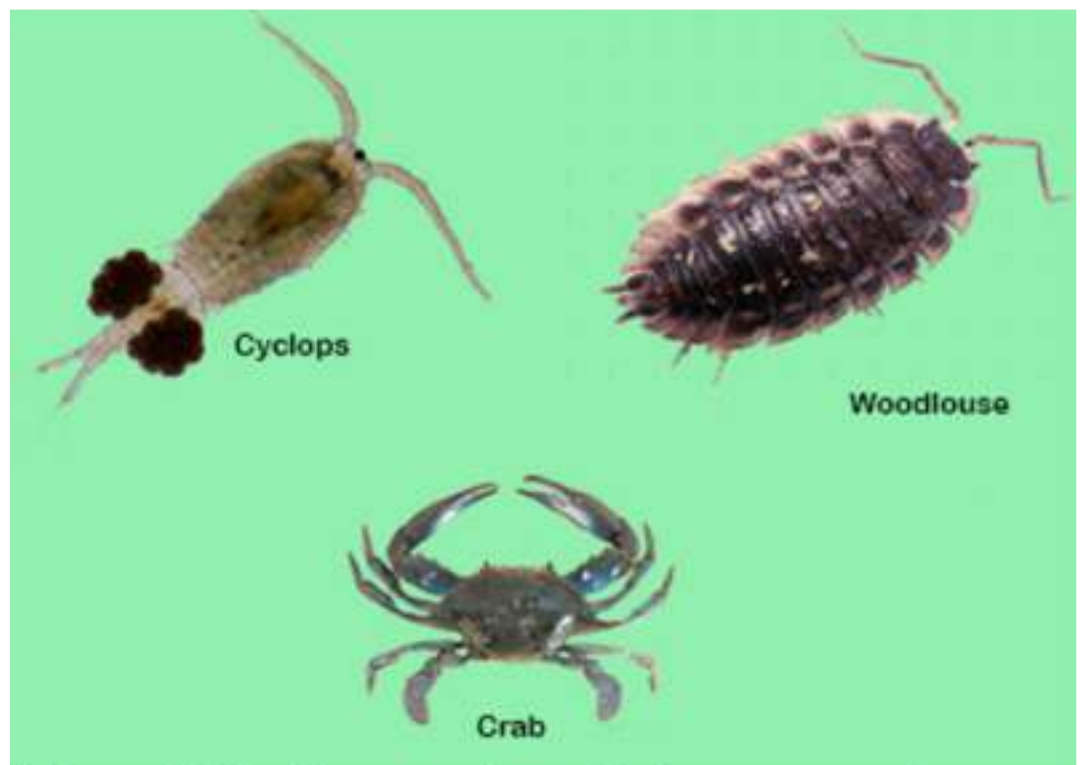

Fig. 10.8 Example of class crustacea

2. Class Insecta : This is the largest group not only of Arthropoda but of all the animal kingdom and has great variety. Insects are found everywhere, many show social behaviour. The body in, insects has three distinct regions head, thorax and abdomen. There are a pair of antennae and compound eyes on the head. The head is usually vertical to the body and jaws are ventrally placed. The thorax has three segments in which are present three pairs of jointed legs and in many one or two pairs of wings. Abdomen has varying number of segments. Brain is formed of fused ganglia and double nerve cord is ventral. Sexes are separate and animals are oviparous. Metamorphosis takes place during development e.g. dragonfly mosquito, butterflies, moths, wasps, and beetles etc. (Fig. 10.9).

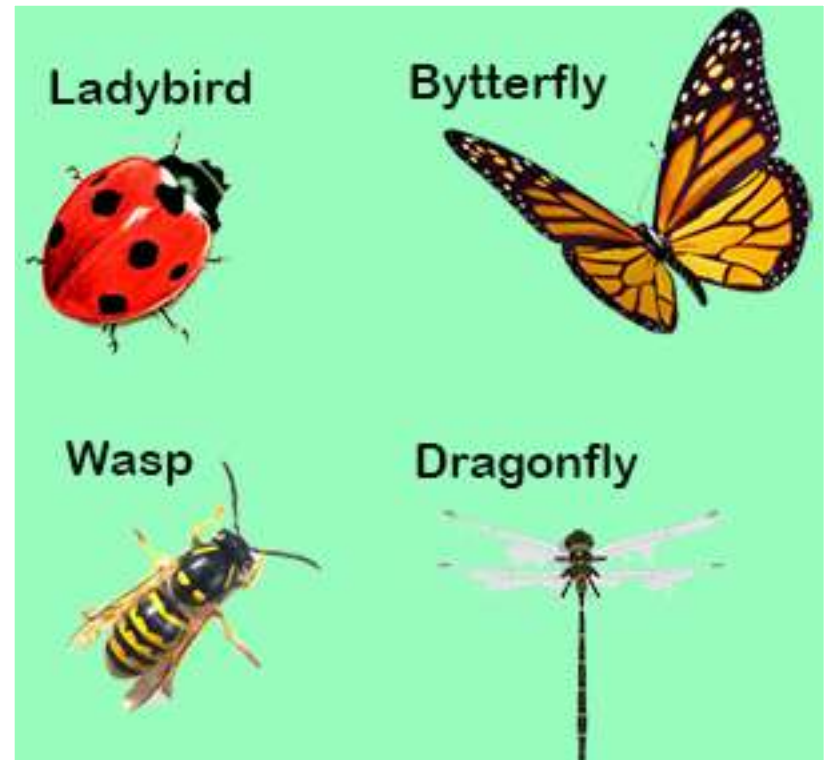

Fig. 10.9 Insects

3. Class Arachnida : Body has the anterior segments that are fused to form a combined cephalothorax, with a pair of appendages called chelicerae with claws, two pairs as pedipalps and four pairs of legs. There are no antennae and no true jaws. Abdomen may be segmented or unsegmented with or without appendages. Respiration is by *gills* or special structures called book lungs, excretion is by the Malpighian tubules. Eyes simple, sexes are separate. They are oviparous (lay eggs). No true metamorphosis e.g. scorpions, spiders, mites and ticks.

Most spiders have eight eyes placed in such a way as to give them panoramic view of the predators and prey.



Fig. 10.10 Arachtiids

4. Class Myriapoda:

The body is divided into large number of segments each having a pair of legs. A pair of antennae and a pair of eyes are present on head e.g. centipedes and millipedes.

General organization of Arthropods

Arthropods have characteristics of higher forms such as bilateral symmetry, triploblastic, coelomic cavity and organ systems and have reached the peak of invertebrate evolution. Two of their main achievements are the chitinous exoskeleton and locomotary mechanism. These animals can walk, swim and fly. The jointed appendages (limbs) have been modified or diversified for various uses in the different sub-groups of Arthropoda.

Chitin is non-living, non-cellular and is secreted by the under lying epidermis. It is made of polysaccharide. On the outer side of chitin, there is a waxy layer. In some Arthropods and in certain parts in other Arthropods chitin is soft and flexible, in others it is hard. In general, it is for protection but it also serves as lever for the movement of muscles of jointed limbs. The chitin in the jaws is used for biting and crushing food. It also forms lens of the compound eyes the copulatory organs and organs of defence and offence.

In the young Arthropods such as insect larvae, chitinous exoskeleton is shed from time to time to allow the growth of the larva. This process of shedding of exoskeleton is called moulting or ecdysis. In short the exoskeleton of chitin in the Arthropods is one of the primary factors in the success of Arthropoda as it helps them to adapt to a wide variety of habitat.

Arthropods share with annelids the characteristic of having the body divided into similar segments. In Arthropoda however segmentation is not metameric and organs are not repeated in the different segments. Each somite typically is provided with a pair of jointed appendages. But this arrangement is often modified with both segments and appendages specialized for different functions in different habitats. However, in all kinds of habitat the jointed appendages provide an efficient means of locomotion, offence and defence and also help in reproduction.

Economic Importance

Man and insects have been at war for the same food, same place to live in. Insects attack man, his domestic animals and also his crops, causing a number of diseases. They are not only a health hazard but also cause economic loss to man by destroying his property and crops. Some insects are also useful to him such as the honey bee or the silk worm. Insects are therefore of great importance to mankind.

1. Harmful Insects : Many types of mosquitoes, flies, fleas, lice and bugs transmit disease causing organisms to man and domestic animals. We are familiar with mosquito of genus *Anopheles*, the female of which transmits *Plasmodium* that causes malaria in man. The Tse-tse fly of African countries transmits *Trypanosoma*, the cause of sleeping sickness and skin diseases. The common house fly carries disease causing organisms to contaminate food and cause cholera, hepatitis etc. Some species of *Trypanosoma* cause diseases in cattle, also.

A number of insects lay eggs on fruits and other commercial crops such as sugarcane, maize, cotton and also on vegetables etc. The larvae of these insects damage fruits and the crops resulting in economic loss to farmers. The locusts that move in large numbers from country to country cause damage to standing crops and other plants.

2. Beneficial insects : The useful insects are the honey bee that provides man with honey and also wax. Similarly the silk worm gives us silk. There are some insects that are predaceous on other harmful insects. Some insects are scavengers and they eat up dead animal and vegetable matter. Insect larvae are source of food for fish.

PHYLUM MOLLUSCA (L. Molluscus - soft)

General Characters

The phylum Mollusca consists of diverse group of organisms which include slow-moving snails and slug, bivalved clams, and highly active cephalopods. The phylum includes over 50,000 living species and is the second largest phylum of invertebrates. Giant squid is the largest invertebrate animal.

Molluscs also show a great diversity of form but all are built on the same basic plan.

Molluscs are triploblastic coelomates which exhibit bilateral symmetry. Most animals possess shell.

The body is covered by a glandular epithelial envelope called mantle which secretes calcareous shell. The shell is protective, however it is handicap to locomotion, therefore some of the more active molluscs show a reduction or loss of shell.

Molluscs are widely distributed. Some groups are exclusively aquatic (e.g., cephalopoda), freshwater or marine. The others include terrestrial animals (land snail) living mostly in moist places.

The body is unsegmented and soft. The body can be divided into head, a ventral muscular foot and a dorsal visceral mass containing most of the internal organs. Over the visceral mass mantle is present which secretes a shell. The space between the shell and mantle cavity contains gills in some animals. In the mouth cavity of many molluscs there is a rasping tongue-like **radula** provided with many horny teeth.

The body is highly organized with complex digestive, respiratory, circulatory, excretory, nervous and reproductive systems.

Digestive system consists of gut with two openings, the mouth and the anus.

The excretory organs are paired nephridia.

Except for Cephalopoda, the circulatory system is open. The coelom is divided into sinuses or blood spaces. Heart pumps the blood into the sinuses. A respiratory pigment of blue in color, called **haemocyanin** is present.

The gaseous exchange is by gills mostly. In some cases such as snail, the mantle cavity is converted into a lung.

The nervous system consists of three pairs of interconnected ganglia present in the head, foot and body regions.

The organ of locomotion is a muscular foot, however in many species the movement is slow. The others are sessile i.e. unable to move.

The sexes are separate. Trochophore larva develops during embryological development.

Classification

The molluscs are classified into six classes. The major classes are:

(i) Gastropoda

These are asymmetrical and their body is covered with usually coiled one piece shell. The animal can withdraw itself into the shell. Both aquatic and terrestrial species are included in this class. The aquatic species have gills while in land forms the mantle cavity is converted into lungs.

The common examples are:

- i. ***Helix aspersa*** : It is commonly termed garden snail.
- ii. **Limax** the slug

(ii) Bivalvia (Pelecypoda)

This class includes bilaterally symmetrical aquatic molluscs. The body is laterally compressed and is enclosed by two pieces of shells hence the name bivalves. They respire by plate-like gills.

The common examples are:

- (i) ***Mytilus***: (marine mussel).
- (ii) ***Anodonta***: (freshwater mussel),
- (iii) ***Ostrea***: (oyster).

(iii) Cephalopoda

The members of this class are bilaterally symmetrical with dorso-ventrally flattened body. All species are aquatic. The shell is much reduced and internal. In most cases it is absent. The animals are highly developed and active.

The common examples are:

- i. **Loligo:** (squid).
- ii. **Sepia:** (cuttlefish).
- iii. **Octopus**



Fig. 10.11 Examples of molluscs

Economic Importance of Mollusca

Some molluscs are indirectly harmful to man but most of them are beneficial. The harmful molluscs are slugs and shipworms. Slugs are injurious to gardens and cultivations. They not only eat leaves but also destroy plants by cutting their roots and stems. Teredo, a shipworm damages wooden parts of ships. But many molluscs are great source of food for man in many parts of world. Large quantities of clams, oysters and mussels are eaten in Far-east, Europe and America. Oysters are regarded as delicacy.

Shells of freshwater mussels are used in button industry. Also shells of oysters are mixed with tar for making roads in America. Shells in certain parts of the world are also used for making ornaments. Some oysters also make valuable pearls e.g. the pearl oyster.

The brain of octopus is exceptionally large and complex for an invertebrate brain. It is enclosed in a shell-like case of 'Cartilage', and endows the octopus with highly developed capabilities to learn and remember. In laboratory, octopus can rapidly learn to associate certain symbols and can open a screw cap jar to obtain food.

PHYLUM ECHINODERMATA - The Spiny skinned animals

General Characteristics

There are over 5,000 known species of echinoderms. They are marine organisms living at the sea bottom.

The body is covered by delicate epidermis. The mesodermal cells develop a firm calcareous endoskeleton which may bear spines and because of its origin, from mesoderm it is called endoskeleton.

Echinoderms are triploblastic coelomates and exhibit radial symmetry. The mouth is on lower surface (oral) and anus is on upper surface (aboral).

The echinodermata are exclusively marine and most of them are found at the bottom along shorelines in shallow seas. Most species are free) moving however some are attached to the substratum.

All the larval forms of these animals exhibit bilateral symmetry but the adults show radial symmetry which is an adaptation for their special mode of life.

The body may be flattened like biscuit (cake urchin), star-shaped with short arms (starfish) globular (sea urchin), star-shaped with long arms (brittle star) or elongated (sea-cucumber). There is a central disc from which arms radiate.

The most unique characteristics of echinoderms is that a water vascular system is present in their coelom. It is a complex system of tubes and spaces surrounding the mouth and passing into the arms and tube feet. The water circulates through these channels. Water enters these canals through a sieve-like plate called madreporite present on the aboral body surface.

The motile species move with the help of tube feet. Each tube foot is a soft saclike structure present along the edges of grooves present in the arms.

The echinoderms exhibit low degree of organization. There are specialized organs for digestion and reproduction, but there are no specialized organs for respiration or excretion. The nervous system is also poorly developed. There is no brain, however a nerve ring is present around the pharyngeal

region. Similarly the circulatory system is poorly organized.

The sexes are separate and the fertilization is external. The larvae such as **bipinnaria** and **brachiolaria** are complex, exhibit bilateral symmetry, and resemble those of chordates.

Regeneration, the ability to reform lost organs is common among echinoderms, starfish, sea cucumber, sea lily, brittle star and sea-urchin exhibit this characteristics.

The echinoderms are comparatively simple in structure, organization and physiology, and deserve a place slightly below the annelid worms. However, these are placed at the top of the list of invertebrate phyla. This is because there are a number of striking resemblances, between the echinoderms and chordates, such as :

a. There is radial cleavage during the development of embryos in both phyla.

b. The blastopore forms the anus in echinoderms as well in chordates (Deuterostomes).

c. There are certain common biochemical peculiarities among echinoderms and chordates e.g. phosphocreatin is present in both.

The common examples are:

Asterias (starfish):

Sea urchin	Sea cucumber
Cake urchin	Brittle star



Brittlestar



Sea Urchin

Fig. 10.12 Examples of Echinoderms.

Echinodermata / Affinities

Echinodermata do not show close relationship to most invertebrates, but they do show affinities with hemichordata. Both these have a number of common features among which are the formation of coelom and retention of blastopore as the site for future anus. In both mesoderm is derived from the cells close to the blastopore. Both possess mesodermal endskeleton where as the exoskeleton is ectodermal in origin while in invertebrates the blastopore develops into mouth.

The above resemblances between two phyla are neither accidental nor due to convergent evolution but are because the two are closely related and both emerged from the same (common) ancestor. Echinoderms also show very close resemblance with chordates because both have mesodermal skeleton, are deuterostomous, in both lower chordates and echinoderms the early development is almost similar. That is why they have been placed closest to phylum chordata.

Phylum Hemichordata

Hemichordates are a group that has a combination of both invertebrate (Echinoderm) and chordate characteristics.

The hemichordate along with Echinoderms and chordates belong to the group deuterostome branch of animal kingdom.

Because of their close relationship to chordates these animals are called prechordates. The common examples of this phylum are *Balanoglossus* and *Saccoglossus*.

General Characters

1. Soft bodied worm-like animal.
2. Body is divided into an anterior proboscis, collar and trunk.
3. Body wall is made of unicellular epidermis with mucus-secreting cells.
4. Digestive tract is straight and may show variations.
5. Coelomic cavities correspond to each of the three body regions i.e. that of proboscis, collar and trunk coelomic pouches.
6. Circulatory system consists of a median dorsal and a median ventral vessel.
7. Respiratory system is composed of gill-slits forming a dorsal row behind collar.
8. Excretory system has single glomerulus connected to blood vessels.
9. Nervous system has a sub-epidermal plexus of cells and fibres.

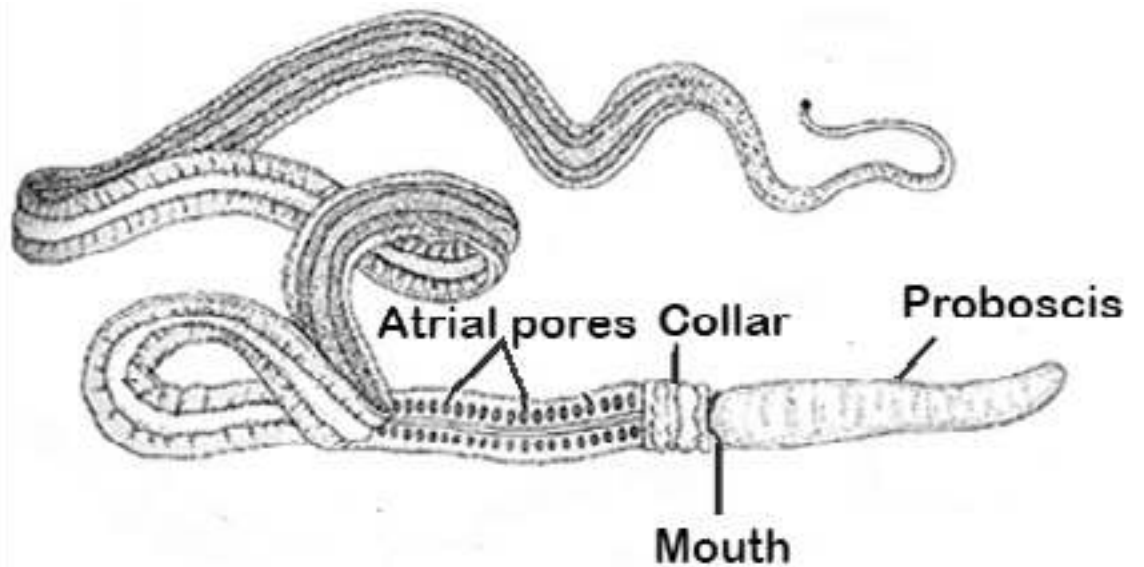

Fig. 10.13 *Balanoglossus* and *Saccoglossus*

Phylum Chordata

This great phylum derives its name from one of the few common characteristics of the group - The notochord. This structure is possessed by all members of the phylum either in the larval or embryonic stages or through out life. The notochord is a rod-like semi rigid body of vacuolated cells which are filled with proteinaceous material which extends in most cases the length of the body between enteric canal and the dorsal hollow central nervous system. Its primary purpose is to support and to stiffen the body that is to act as skeletal axis.

It seems that the endoskeleton is the chief basic factor in the development and specialization of higher animals.

The animals most familiar to us belong to the chordates including man himself.

The chordates show great variety and inhabit all kinds of habitat. All chordates possess three basic characters which are as follows:

1. As already mentioned all possess the notochord.
2. All chordates have central nervous system that is dorsal in position and is hollow.
3. All chordates develop paired gill openings in embryonic stage. In some these are non-functional, while in others they are functional for some period in their liie history e.g. frogs etc. in still other these are functional throughout life e.g. amphioxus, and fishes etc.

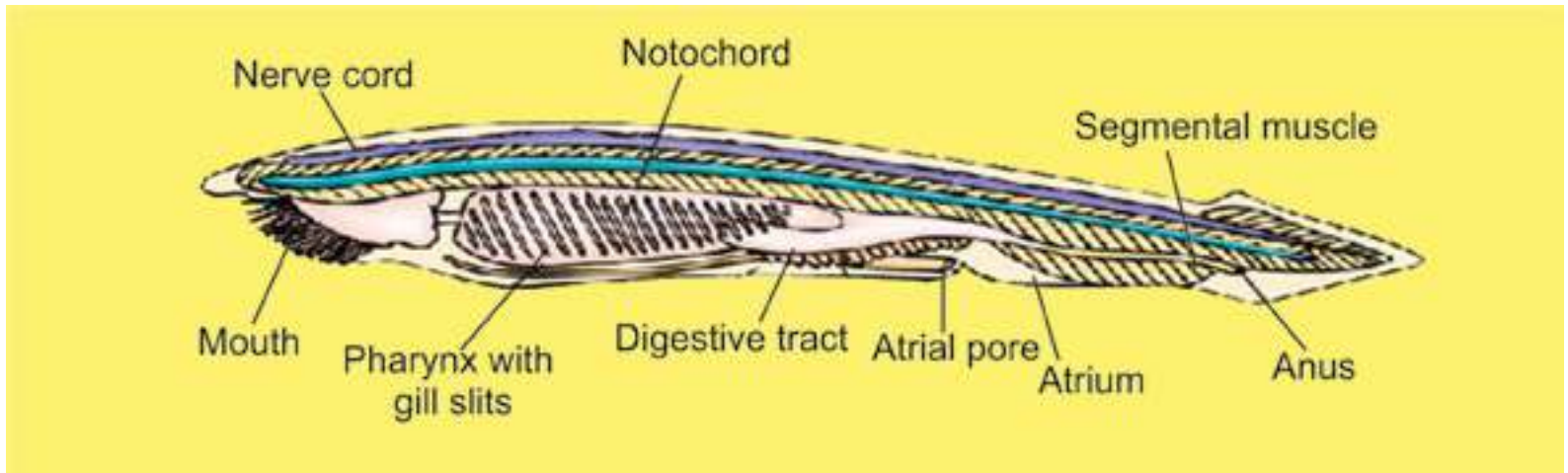

Fig. 10.14 Amphioxus

Chordates have been divided into lower chordates, e.g. *Amphioxus* etc. and higher chordates which are the vertebrates in which the notochord is replaced by the vertebral column and a bony brain case cranium is also formed due to which they are also called craniates. Phylum Chordata has been sub-divided as follows:

Protochordata (Acrania) (Lower Chordates)

Sub-phylum: Urochordata : Notochord and nerve cord only in the free-swimming larvae. Adults are sessile and enclosed in a covering called tunic. Therefore, they are also called tunicates e.g. *Molgula*.

Sub-phylum: Cephalochordata: Notochord and nerve cord extend along the entire length of the body and persist throughout life e.g. *Amphioxus*.

Table 10.2 Classification of Phylum Chordates

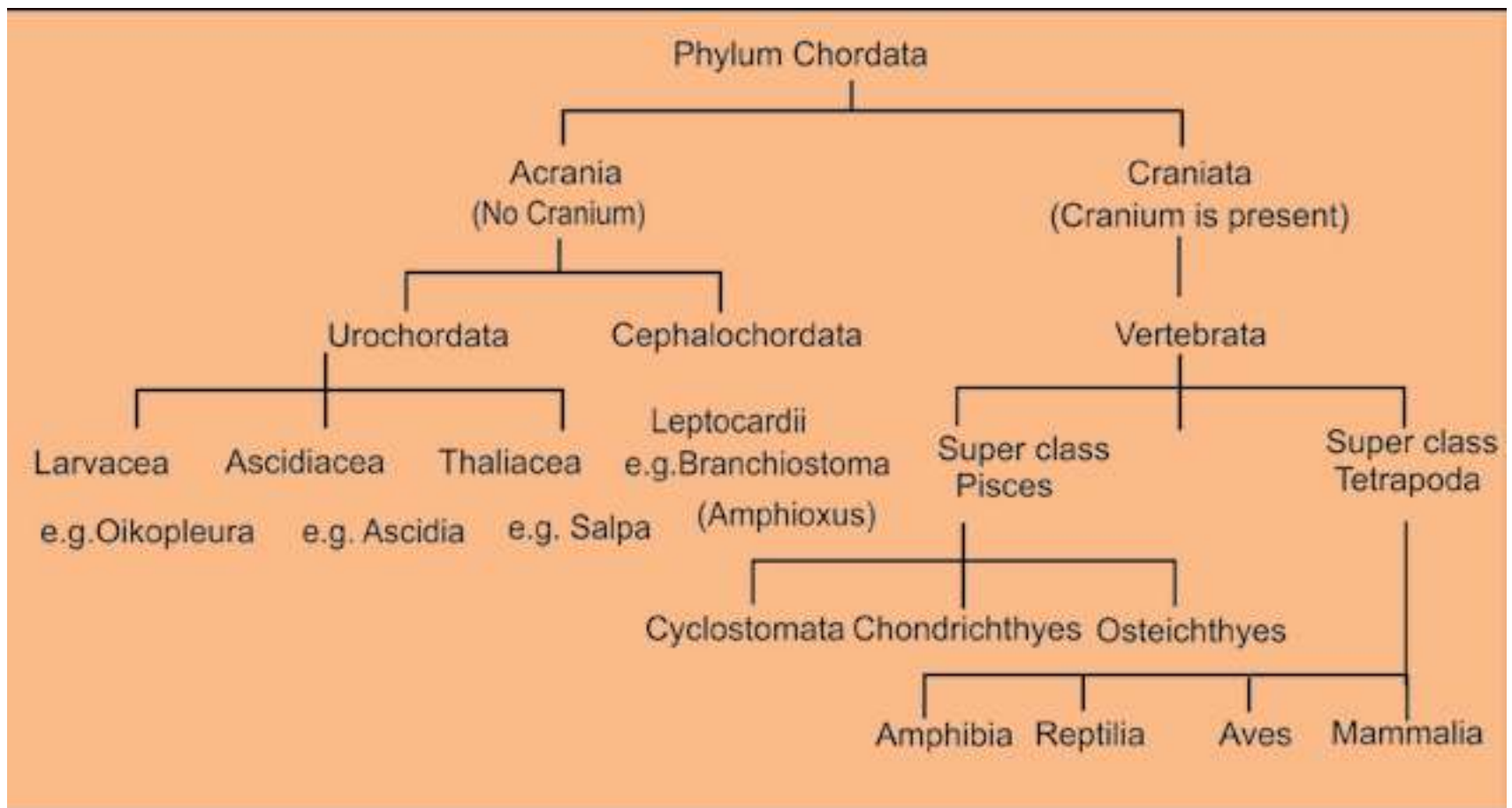

Sub-Phylum Vertebrate (Craniate) (Higher chordates)

It includes animals which have cranium in which the brain is enclosed. It includes animals with vertebral column that means that all chordates in this, group are under subphylum vertebrata and are therefore vertebrates. Table 10.2 gives an outline of classification of sub-phylum vertebrata.

It is customary to place vertebrates into two super classes.

- (1) Pisces (Fishes) which includes class cyclostomata, class chondrichthyes, class osteichthyes.
- (2) Tetrapoda (Four footed) which includes the classes amphibia, reptilia, aves and mammalia.

The former is made up of strictly aquatic forms and the latter of the land dwelling animals. Vertebrates maybe divided into anamniotes or those without foetal membranes (cyclostomata, chondrichthyes, osteichthyes and amphibia) and amniota or those with foetal membranes (reptilia, aves and mammals)

Superclass Pisces

This super class includes classes, cyclostomata, chondrichthyes and osteichthyes. The class cyclostomata includes most primitive living vertebrates which are without jaws. This distinguishes them from the rest of the vertebrates. They are represented by the lampreys and hagfish. Some of their characteristics are as follows:

1. Body is long eel-like.
2. Scales absent.
3. No paired appendages.
4. Cartilaginous Skeleton.
5. Ventral Suctorial mouth.
6. Heart with one auricle.
7. Six to fourteen pairs of gills.
8. Digestive system lacks stomach.
9. Sexes are separate in lampreys. Hag fishes are hermaphrodite.
10. Fertilization external and there is a long larval period in Lamprey.



Fig. 10.15 Lamprey

Class Chondrichthyes

This group includes the sharks and rays which have skeleton of cartilage but have many resemblances to the bony fishes, the cartilaginous skeleton is considered a degenerated character rather than primitive character. Their main features are:

1. Body fusiform.
2. Mouth ventral olfactory sacs not connected to mouth cavity.
3. Placoid scales on the body.
4. Endoskeleton entirely cartilaginous.

5. Digestive system with J-shaped stomach.
6. Circulatory system has many pairs of aortic arches.
7. Respiration by means of 5 - 7 pairs of gills without the covering i.e. operculum.
8. No swim bladder.
9. Sexes separate.
10. Oviparous or viviparous

With the exception of whale the sharks are the largest living vertebrates, some reaching 30 - 50 feet in length.

The skates and rays are bottom dwelling fishes. In these the anterior pairs of fins (Pectoral fins) are much enlarged and are used for swimming like wings. Two members of this group are of special interest (1) the sting rays and (2) electric rays.

In the sting ray the tail is long & whip-like and has sharp spines which can inflict very dangerous wounds. The electric ray on the other hand has certain dorsal muscles modified into powerful electric organ which can give severe shocks & stun their prey.

Sharks are of economic importance; most are highly destructive to fish, lobsters & crabs. In some parts of the world sharks are used as food by man. Commercially shark liver oil is extracted and used in medicine as a source of vitamin A and D and shark skin leather is used for making articles.



Fig. 10.16 Shark

Following are the characteristics of bony fishes :

1. They have more or less bony skeleton which has replaced the cartilaginous skeleton.
2. Notochord may persist in parts.
3. The skin has embedded dermal scales which may be ganoid, cycloid or ctenoid scales. No placoid scales.
4. Fins both, median (single) or paired and have fin rays of cartilage or bone.
5. Mouth is terminal. Jaws either with or without teeth.
6. Respiration by gills supported by bony gill arches and covered by operculum.
7. A swim bladder is usually present with or without connection with the pharynx. This helps in bouyancy.
8. Two chambered heart with one atrium and one ventricle. Blood has nucleated red cells.
8. Brain with 10 pairs of cranial nerves.
9. Sexes are separate, gonads paired. Fertilization is usually external.

Adaptations to Aquatic Life:

The major adaptations in fishes for the aquatic mode of life are as follows:

1. **Stream - lined body** (boat shaped) The body of fish is such that it offers little resistance to water while swimming.
2. **Swim bladder:** This is found in most bony fish except a few; it may or may not be connected to pharynx. It is mainly a hydrostatic organ & can change the gravity of fish by filling itself with gas. The fish can thus float high or sink lower in water. The gases that fill the swim bladder are either oxygen, carbon dioxide and nitrogen and may be secreted by the gland in the swim bladder itself. In those fishes in which the swim bladder is connected to pharynx the bladder may be filled by gulping of air.
3. **Fins:** Fins are another important adaptation to aquatic life and are of two types (1) paired fins (Pectoral and Pelvic) and (2) unpaired fins which are dorsal, caudal (tail) and anal fins. Fins help in swimming as they keep balance of fish in water.
4. **Circulatory System :** Heart with two chambers, with afferent & efferent branchial system.
5. **Respiratory system:** In most fishes respiratory organs are the gills, adapted to receive oxygen dissolved in water and remove carbon dioxide in water as the gills have network of blood capillaries

Excretory Organs: Kidneys of fish are also modified for excretion in the aquatic environment.

The vertebrates already considered are adapted to strict aquatic life. The group of ancient fish known as **dipnoi** showed modification of aquatic breathing system to meet the conditions of terrestrial life by developing lungs. But this case is only an incident in the transition to land. There are a number of differences between water and land habitats.

1. Oxygen is more in the air than in water.
2. Dissolved substances are present in water for example different kinds of salts.
3. Temperature changes are more drastic in the terrestrial environment.
4. Land habitat provides a great variety of cover and shelter than aquatic habitat.
5. As a medium water provides greater support to the body than air.
6. Land affords a greater variety of breeding places than does water.

In their transition from aquatic to land environment animals had to undergo modifications or adaptations to cope with the above conditions on land. This included:

1. Development of skin for protection against dry conditions of land.
2. The eggs of land animals are protected by shells from drying and mechanical injury. Also the size of the egg is large to provide space for storage of food.
3. The terrestrial animals developed lungs in place of gills which could take oxygen from air.
4. In connection with the development of lungs there are corresponding changes in the circulatory system to take oxygen from air.
5. For locomotion the paddle-like fins are replaced by jointed appendages modified for walking, running, climbing and flying.
6. Sensory organs have become more advanced and specialized.

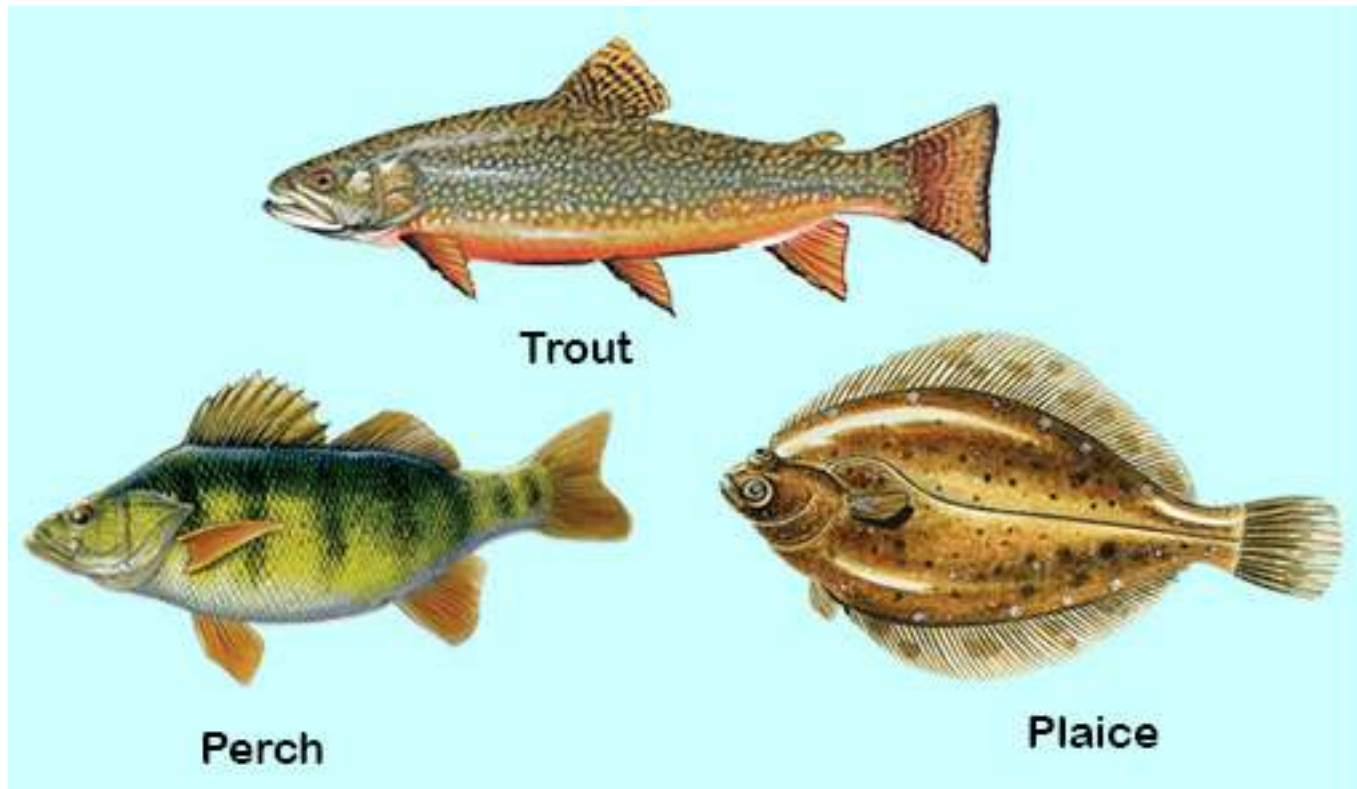

Fig. 10.17 Bony fishes

Super class Tetrapoda: These have 2 pairs of jointed limbs (tetrapods)
Class Amphibia

Amphibians are on the border line between aquatic and true terrestrial animals. Fossil evidence from the **Devonian** period of earth's history suggests that a large population of fish belonging to the group lobe-fins (dipnoi) came to live in shallow fresh water. Some of these crawled from one pool to another and therefore spent some time on land. This gave rise to the group that we recognize as amphibians which are the first vertebrates to come on land. Although amphibians have acquired certain characters enabling them to live on land but at the same time they have retained some aquatic characters as the result of their dependence on aquatic habitat. This double life is expressed in their name. Structurally they are between the fish on one hand and the reptiles on the other. In the transitions from water to land amphibians have developed limbs in place of fins, lungs in place of gills and some changes in skin. Their circulatory system provides for lung circulation but all of them in larval form retain their link with aquatic life by having gills, circulation of blood, digestive system which are representative of aquatic mode of life. Because of their dependence on water for their life history they are not a very successful group of vertebrates and are confined to areas only where they can find water or moist conditions.

The characteristic features of amphibians therefore are:

1. Skeleton is mostly bony. Body form varies greatly in the different amphibians, tailed or without tail.
2. Limbs usually four (tetrapod condition) but some are legless (e.g. caecilians). Webbed feet often present.
3. Skin smooth and moist with many glands. In some glands are poisonous, pigment cells (chromatophores) present in the skin. Scales absent.
4. Respiration takes place by gills in the larval stage and by lungs and skin in the adult.
5. Heart is 3-chambered with respect to atria and ventricle sinus venosus, truncus arteriosus are present, double circulation takes place through the heart.
6. Sexes separate, fertilization external, larval stage present.
7. Changes into adult by metamorphosis. Amphibians are anamniotes.
8. Amphibians are cold blooded (poikilothermic) animals and hibernate in winter.
Examples frogs, toads, and salamander.

Class Reptilia:

Reptiles are adapted for existence solely on land in contrast to amphibians that are still tied more or less to water or moist habitat. This indicates that reptiles have certain adaptations not found in amphibians. Some of these advancements shown by reptiles are their characteristic features which are as follows:

1. Reptiles have developed some sort of copulatory organ necessary for internal fertilization.
2. In amniotic eggs of reptiles the shell is leathery which can resist dryness and injury. They have large yolky eggs.
3. Reptiles have dry scaly skin which is adapted to land life.
4. Reptiles have protective embryonic membranes amnion, allantois, and chorion.
5. In reptiles the ventricle of heart is incompletely partitioned ensuring more oxygen supply through blood circulation to all parts of the body. In crocodiles ventricle is completely partitioned into two.
6. Most reptiles have better developed limbs well adapted for efficient locomotion.
7. Reptiles like amphibians are cold blooded (poikilothermic) and hibernate in winter.

The above characteristics are for terrestrial habitat in which the reptiles mostly live. However, it is an established fact that reptiles have evolved from amphibians by undergoing the above changes and have become fully terrestrial.

Reptiles flourished throughout Mesozoic era (225-65 million years). The climate which had been suitable for reptiles in that period, became less favourable to them in tertiary period. So most of them became extinct. The existing reptiles belong to four, out of a dozen or more main lines that existed in the past.

The present day reptiles are, firstly, the lizards and snakes. Secondly the tuatara (sphenodon) of New Zealand, which have survived upto today with little change. Thirdly the crocodiles, which are an offshoot from the stock from which modern birds were derived. The reptiles of today have been derived from dinosaurs of Jurassic (195-136 million years), and cretaceous period (136-65 million years).

The modern reptiles for the most part live in the temperate and tropical zones indeed they flourish only in the latter.

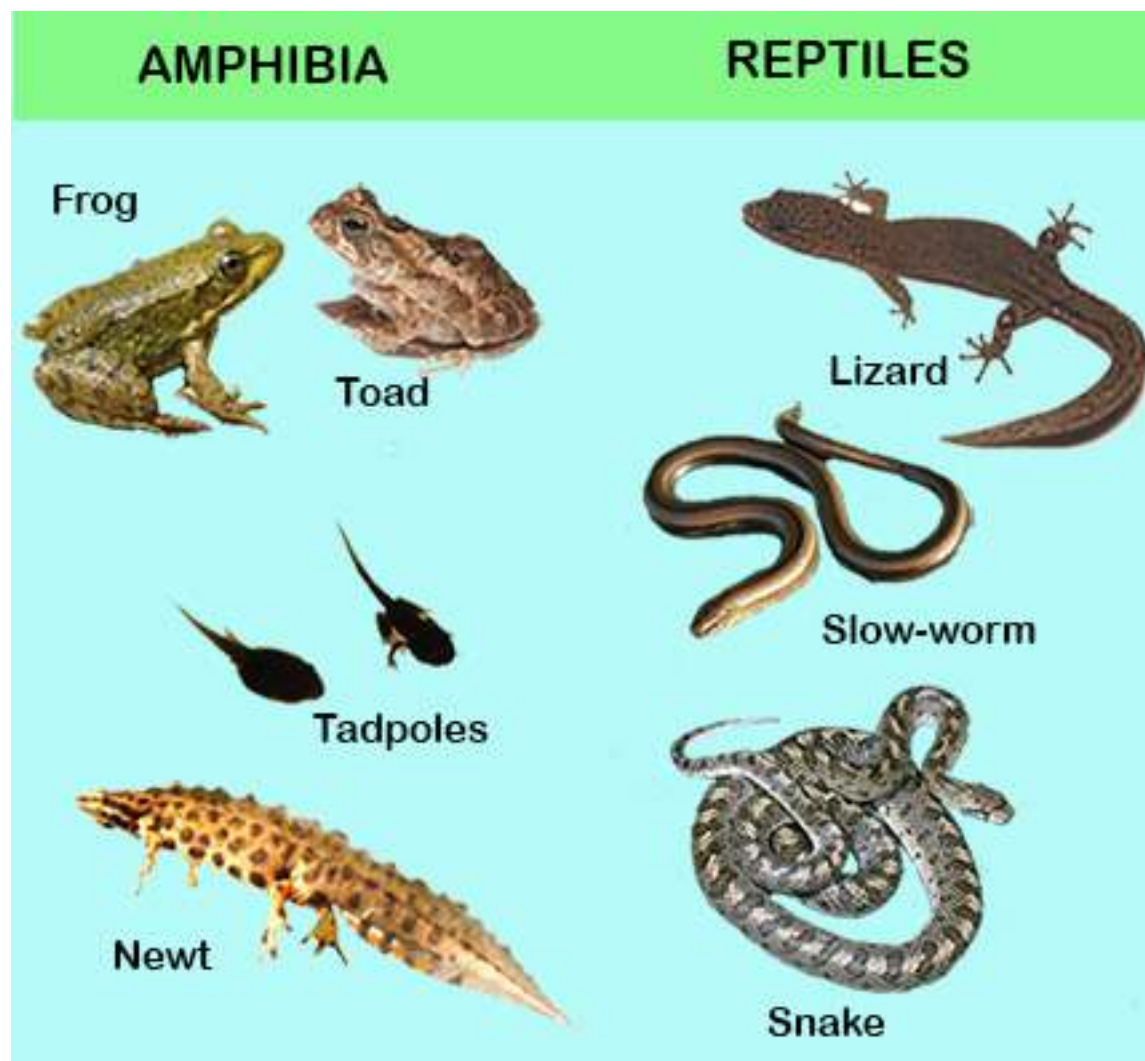

Fig. 10.18 Amphibians and Reptiles

Class Aves - Birds

Birds are one of the most interesting and most widely known group of animals. Birds share with mammals the highest development in the animal kingdom. It is believed that both birds and mammals have evolved from reptiles along different lines. The earliest known bird fossil is that of archaeopteryx, two species of which have been found from rocks of Jurassic period of earth's history. The fossil shows that archaeopteryx, was about the size of a crow with skull similar to that of present day birds. It had bony teeth in the jaw socket unlike modern birds which do not have teeth. Jaws extended into a beak and there was a long tail. Each wing had three claws. With the exception of feathers these birds showed resemblance to the dinosaurs (giant reptiles of the past). Many fossils of birds from later eras of earth history have also been found that had teeth. The above evidence suggests that birds evolved from reptilian ancestors. The archaeopteryx and others had characteristic of both reptiles and birds and therefore form a connecting link between the two distinct groups.



In eagle both ovaries and oviducts are functional.

Archaeopteryx

Characters of Birds

1. Body is stream-lined and spindle shaped with four divisions, viz; head, neck, trunk and tail. These are warm-blooded (homeothermic).
2. Limbs are adapted for flying. The fore-limbs are modified into wings and hind limbs for perching and in some birds for running as in ostrich.
3. There is the epidermal exoskeleton of feathers, legs bear scales.
4. The skeleton is light due to air spaces which is an adaptation for flying.
5. The skull has large sockets, jaws extend into horny beak, teeth are absent.
6. The circulatory system has 4-chambered heart and there is only right aorta which curves to the right side and then bends backwards.
7. The lungs have extensions known as air-sacs which extend into the bones also.
8. The organ of voice is called syrinx, it is situated at the lower end of trachea near the origin of the two bronchi.
9. Excretory system does not have a bladder, urine is semi solid.
10. Sexes are separate. Fertilization is internal and eggs are of large size with much yolk. Only one ovary and oviduct is functional.
11. Since birds do not have teeth they have developed a thick muscular structure (Gizzard) which is used for crushing food.
12. Some birds have secondarily lost the power of flight and are called running birds e.g. Ostrich, Kiwi, etc.



Fig. 10.19 Birds

Class Mammalia - Mammals

The term mammal was given by Linnaeus to the group of animals which are nourished by milk from the breast of the mother. The group is considered to be the highest in the animal kingdom. Their advancement over other groups is quite pronounced. The most important advancement is the evolution and development of their brain (nervous system) over the other vertebrates. It is universally accepted by biologists that mammals have evolved from reptilian ancestors, the **cotylosaurs**. This has been determined on the basis of the fossil record which is easily available because of the hard bones that were preserved as fossils, unlike the birds which have soft bones and mostly have not been preserved. The ancestors of mammals lived simultaneously along with reptiles during the Jurassic times and have been called mammal-like reptiles. Some were only of the size of mice and lived on trees. One of these early reptile was **varanope** that was found as fossil in Texas. Probably at least five groups of such mammal-like reptiles developed mammalian characters and were 50% mammals. Mammals became dominant in the **Cenozoic period**.

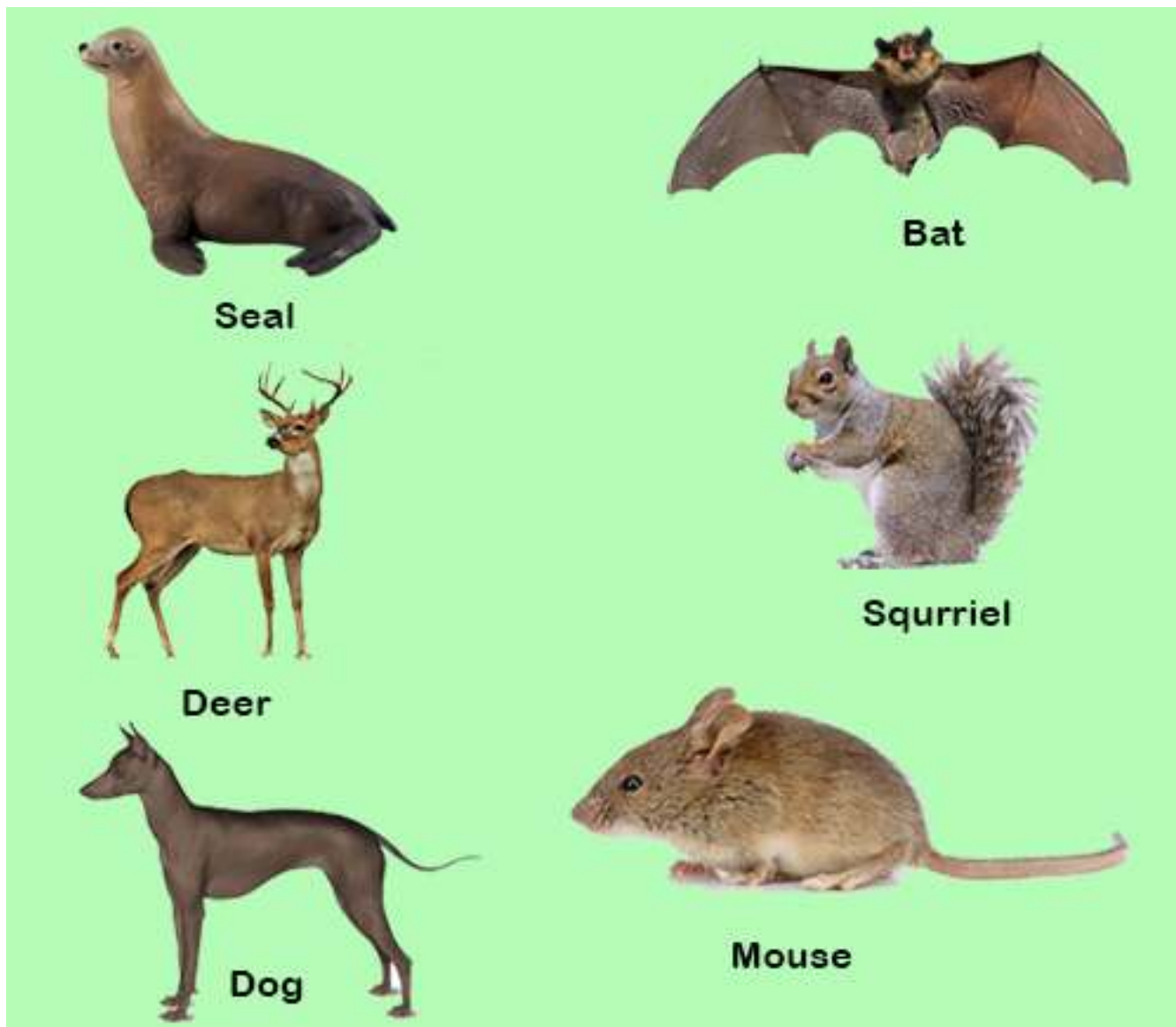

Fig. 10.20 Mammals

General Characters of Mammals

Although mammals have evolved from reptiles they show many important structural differences. These differences are in fact the general characters of mammals which are as follows:-

1. Most mammals have a body covering of hair instead of scales.
2. There is a muscular diaphragm in mammals that separates the thoracic and abdominal cavities. This structure is not found in any previous group.
3. The lower jaw in mammals is composed of only one large bone and articulates directly with skull.
4. External ear or pinna is present. There is a chain of three bones in the ear **Malleus, Incus & Stapes.**
5. Mammals have deciduous and permanent teeth in some mammals e.g. man the teeth are in two sets, one in early life the milk teeth and later the permanent teeth.
6. Mammals have 4-chambered heart and only left aortic arch (in birds it is right).
7. Mammals are warm blooded (Homeothermic) animals.
8. The red blood cells are non-nucleated.
9. Mammals have well developed voice apparatus, the larynx and epiglottis.
10. Most mammals give birth to young (viviparous).
11. Mammals feed their young on milk produced by mammary glands of mother. Mammals are

classified into three sub-classes.

- | | | |
|----------------|---|---------------------------------|
| 1. Prototheria | - | egg-laying mammals |
| 2. Metatheria | - | pouched mammals |
| 3. Eutheria | - | Placental mammals including man |

1. Sub-Class Prototheria The Prototheria is that group which has characteristics of both reptiles and mammals and therefore form a connecting link between the two. They also provide evidence of the evolution/origin of mammals from reptilian stock. Certain members of this sub-class are adapted for aquatic life as the duck bill which has a bill similar to that of a duck and has webbed toes. It has thick fur on its body. The female has mammary glands to feed the young. Both these are mammalian characters. At the same time these animals have cloaca and cloacal opening instead of separate openings for digestive system and urinogenital system. Both these characters are reptilian characters. These animals are found in Australia, e.g. Duck bill Platypus & Echidna (Spiny anteater).

2. Sub-Class Metatheria Next to Prototheria, the Metatheria are the most primitive mammals They are characterized by an abdominal pouch the **marsupium** where they rear their young. The young when born are immature and are carried by the mother in the marsupium till they develop to their maximum. During this period they are fed on the milk produced by the milk glands of mother, the nipples of which are in the marsupium. For this reason these animals are also called marsupials or pouched mammals, e.g. Opossum, Kangaroo and Tasmanian wolf found in Australia and America.

3. Sub-Class Eutheria This sub-class includes placental mammals. In the body of mother development of young is maximum and the young when born are fully developed. In these mammals during development a structure known as **placenta** is formed through which the fetus is nourished. Also the placenta has endocrine function i.e. it produces certain hormones, for this reason these mammals are also called **placental mammals**. Placental mammals have maximum mammalian characters but in some the hair have become modified into scales (pangolin) and spines (porcupine). Examples are man, whale, elephant, horse, rat, mice, bat, dolphin, etc.

Mammals being a very successful group live in all kinds of habitat i.e. land, fresh water and sea for which their bodies are modified.

EXERCISE

Q1. Fill in the blanks.

- (i) Protozoans have been placed in a separate kingdom known as _____.
- (ii) The sponges do not have any symmetry and are therefore called _____.
- (iii) Between ectoderm and endoderm the coelenterates have a non-cellular _____.
- (iv) *Taenia solium* has _____ and _____ for attachment to the intestine of host.
- (v) In annelids the body segmentation is of the type known as _____.
- (vi) In insects there are _____ pairs of legs present in the _____ region of the body.
- (vii) The organ of locomotion in molluscs is the _____.
- (viii) In animals where there are definite left & right sides the symmetry is _____.
- (ix) The system in which water moves inside the body of an echinoderm is called _____.
- (x) Coelom is the body cavity formed from the _____ layer.

Q.2. Each question has few options. Encircle the correct answer.

Vertebrates that develop embryonic membranes around their embryo are called (Amniotes, Anamniotes)

- (i) In animals the bodies of which can be divided in two equal halves only in one plane are (asymmetrical, bilaterally symmetrical, radially symmetrical)
- (ii) Animals that have their body cavity filled with parenchyma are (Acoelomates, Coelomate, Pseudocoelomates)
- (iii) The vertebrates in which placenta is formed during the development of faetus are (Pisces, Aves, Mammalia)
- (iv) In amphibians the necessary requirements to spend their life history are (land, water, or both)
- (v) Trypanosoma causes the diseases (Malaria, Sleeping sickness)
- (vi) In annelids the organs of excretion are (flame-cells, nephridia, kidneys) In arthropoda the body cavity is (pseudocoeloms, enterocoel, haemocoel)
- (vii) In mollusca the foot is used for (capturing prey, locomotion, or both)

Q .3. Extensive questions.

- (i) What are Cnidaria? Explain the diploblastic origin, alternation of generations in Cnidaria.
- (ii) Describe the parasitic adaptations in phylum Platyhelminthes - How does tape worms affect a person.
- (iii) Give the symptoms of the disease caused by certain nematodes.
- (iv) Give an account of the major groups of Arthropods. What is the economic importance of insects.

- (v) Give the two major classes of the pisces and explain the adaptations of aquatic mode of life in fishes.
- (vi) Give the adaptations for aerial mode of life in birds. What is their origin.
- (vii) What are the general characteristics of mammals? How do the three subclasses protheria, metatheria and eutheria differ from one another.
- (viii) Distinguish between the following by giving examples
 - (a) Radial and Bilateral Symmetry.
 - (b) Diploblastic and triploblastic animals.
 - (c) Anamniotes and amniotes.

CHAPTER

11

BIOENERGETICS

Animation 11: Bioenergetics
Source & Credit: Wikispaces

Bioenergetics is the quantitative study of energy relationships and energy conversions in biological systems. Biological energy transformations obey the laws of thermodynamics.

All organisms need free energy for keeping themselves alive and functioning. All life on this planet Earth is powered, directly or indirectly, by solar energy. But no organism can make direct use of sunlight as source of energy for metabolism; all can use chemical energy in the food such as sugars etc. The chloroplasts of the plants capture light energy coming from the sun and convert it into chemical energy that gets stored in sugar and then in other organic molecules.

With the emergence of photosynthesis on earth, molecular oxygen began to accumulate slowly in the atmosphere. The presence of free oxygen made possible the evolution of respiration. Respiration releases great deal of energy, and couples some of this energy to the formation of adenosine triphosphate (ATP) molecules. ATP is a kind of chemical link between **catabolism** and **anabolism**.

The process of photosynthesis helps understand some of the principles of energy transformation (Bioenergetics) in living systems. Photosynthetic organisms (higher land plants for instance) use solar energy to synthesize organic compounds (such as carbohydrates) that can not be formed without the input of energy. Energy stored in these molecules can be used later to power cellular processes and can serve as the energy source for all forms of life. Whereas photosynthesis provides the carbohydrate substrate, **glycolysis** and respiration are the processes whereby the energy stored in carbohydrate is released in a controlled manner. So the photosynthesis acts as an energy-capturing while respiration as an energy releasing process.

PHOTOSYNTHESIS (CONVERSION OF SOLAR ENERGY INTO CHEMICAL ENERGY)

Photosynthesis can be defined as the process in which energy-poor inorganic oxidised compounds of carbon (i.e. CO_2) and hydrogen (i.e. mainly water) are reduced to energy-rich carbohydrate (i.e. sugar-glucose) using the light energy that is absorbed and converted into chemical energy by chlorophyll and some other photosynthetic pigments. The process of photosynthesis in green plants can be summarised as:

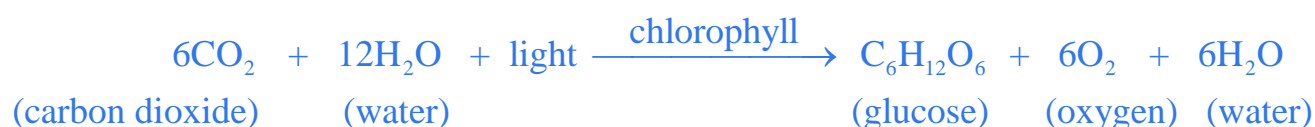

Photosynthetic Reactants and Products

From above overall reaction of photosynthesis it becomes evident that carbon dioxide, water and light are the reactants while glucose and oxygen are the products. Water appears on both sides of the equation because water is used as reactant in some reactions and released as product in other. However, because there is no net yield of H_2O , we can simplify the summary equation of photosynthesis for purpose of discussion:



This is almost exactly opposite to the overall equation of aerobic respiration ($\text{C}_6\text{H}_{12}\text{O}_6 + 6\text{O}_2 \rightarrow 6\text{CO}_2 + 6\text{H}_2\text{O} + \text{energy}$). Photosynthesis uses the products of respiration and respiration uses the products of photosynthesis. There is another important difference between the two processes : Photosynthesis occurs only during day time, whereas respiration goes on day and night. During darkness leaves (and other actively metabolizing cells) respire and utilize oxygen and release carbon dioxide. At dawn and dusk, when light intensity is low, the rate of photosynthesis and respiration may, for a short time, equal one another. Thus the oxygen released from photosynthesis is just the amount required for cellular respiration. Also, the carbon dioxide released by respiration just equals the quantity required by photosynthesizing cells. At this moment there is no net gas exchange between the leaves and the atmosphere. This is termed as **compensation point**. As the light intensity increases, so does the rate of photosynthesis and hence the requirement for more carbon dioxide increases which respiration alone cannot supply. Similarly, the oxygen produced during photosynthesis is more than the need of the respiring cells, so the result is the net release of oxygen coupled with the uptake of carbon dioxide.

Water and Photosynthesis

Oxygen released during photosynthesis comes from water, and is an important source of atmospheric oxygen which most organisms need for aerobic respiration and thus for obtaining energy to live. In 1930s, Van Niel hypothesized that plants split water as a source of hydrogen, releasing oxygen as a by-product. Niel's hypothesis was based on his investigations on photosynthesis in bacteria that make carbohydrate from carbon dioxide, but do not release oxygen.

Niel's hypothesis that source of oxygen released during photosynthesis is water and not carbon dioxide, was later confirmed by scientists during 1940s when first use of an isotopic tracer (O^{18}) in biological research was made. Water and carbon dioxide containing heavy-oxygen isotope O^{18} were prepared in the laboratory. Experimental green plants in one group were supplied with H_2O containing O^{18} and with CO_2 containing only common oxygen O^{16} . Plants in the second group were supplied with H_2O containing common oxygen O^{16} but with CO_2 containing O^{18} .

It was found that plants of first group produced O^{18} but the plants of second group did not.

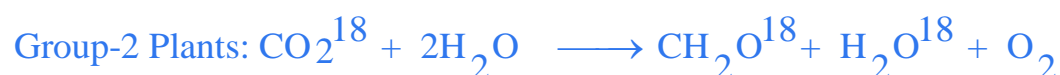
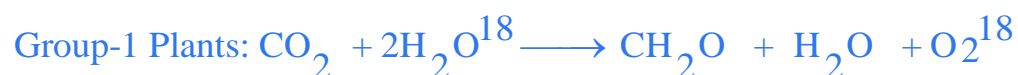

Water is thus one of the raw materials of photosynthesis, other being carbon dioxide. Hydrogen produced by splitting of water reduces NADP to $NADPH_2$ ($NADPH + H^+$).

NADPH is the "reducing power" which, along with ATP also formed during '**light reactions**', is used to reduce CO_2 to form sugar during '**dark reactions**'.

CHLOROPLASTS - THE SITES OF PHOTOSYNTHESIS IN PLANTS

All green parts of a plant have chloroplasts, but the leaves are the major sites of

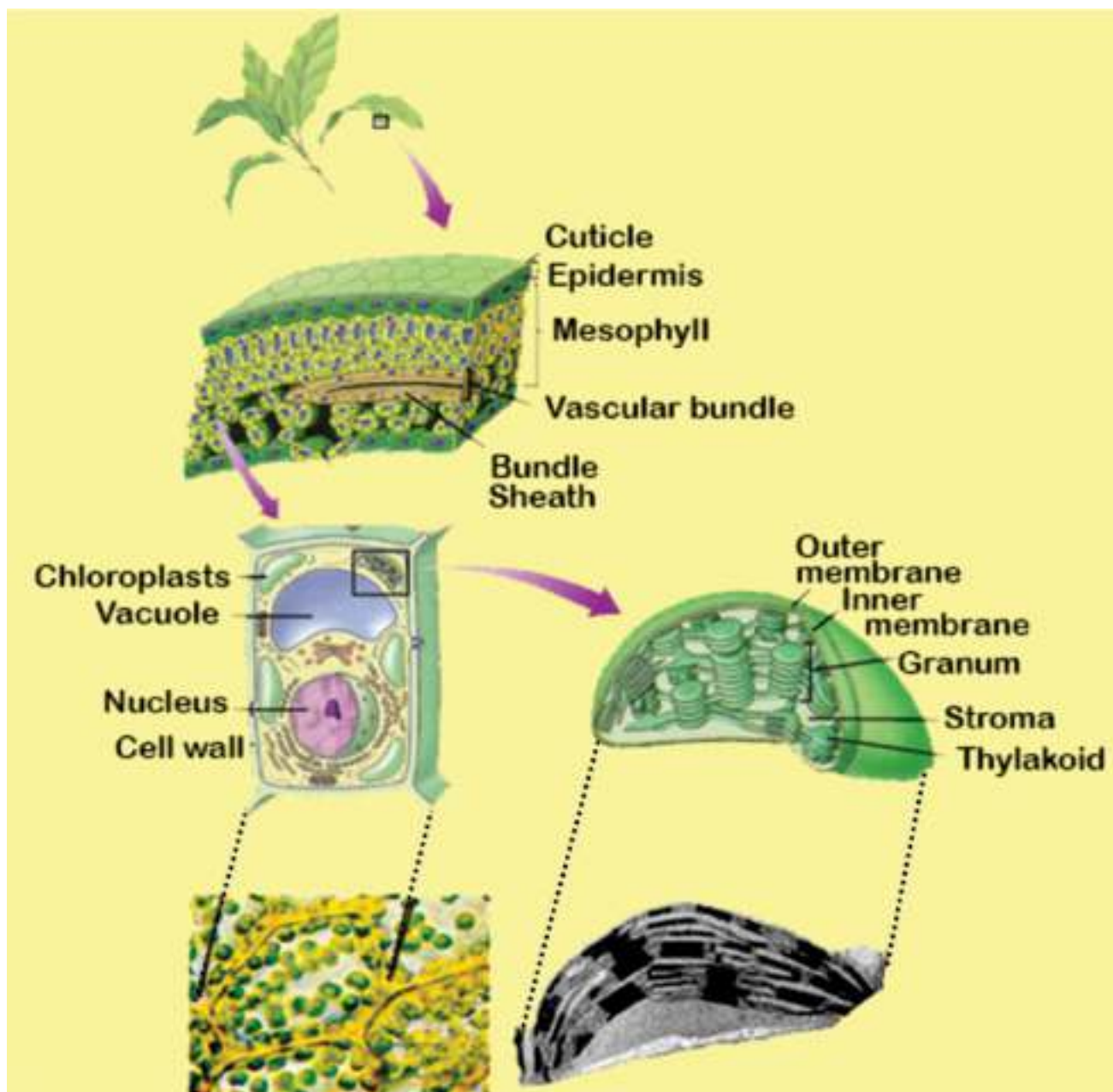

Fig. 11.1 A plant possesses thick layer of mesophyll cells rich in chloroplasts. Thylakoids in chloroplasts are stacked into grana. Light reactions take place on the grana, and dark reactions in the stroma.

photosynthesis in most plants. Chloroplasts are present in very large number, about half a million per square millimeter of leaf surface. Chloroplasts are present mainly in the cells of mesophyll tissue inside the leaf (Fig. 11.1). Each mesophyll cell has about 20-100 chloroplasts. Chloroplast has a double membrane envelope that encloses dense fluid-filled region, the **stroma** which contains most of the enzymes required to produce carbohydrate molecules. Another system of membranes is suspended in the stroma. These membranes form an elaborate interconnected set of flat, disc like sacs called **thylakoids**. The thylakoid membrane encloses a fluid-filled '**thylakoid interior space**' or **lumen**, which is separated from the stroma by thylakoid membrane. In some places, thylakoid sacs are stacked in columns called **grana** (sing **granum**). Chlorophyll (and other photosynthetic

pigments) are found embedded in the thylakoid membranes and impart green colour to the plant. Electron acceptors of photosynthetic 'Electron Transport Chain' are also parts of these membranes. Thylakoid membranes are thus involved in ATP synthesis by **chemiosmosis**.

Chlorophyll (and other pigments) absorb light energy, which is converted into chemical energy of ATP and NADPH, the products which are used to synthesize sugar in the stroma of chloroplast.

Photosynthetic prokaryotes lack chloroplasts but they do have unstacked photosynthetic membranes which work like thylakoids.

PHOTOSYNTHETIC PIGMENTS

Light can work in chloroplasts only if it is absorbed. Pigments are the substances that absorb visible light (380-750 nm in wave length). Different pigments absorb light of different wave lengths (colours), and the wave lengths that are absorbed disappear. An instrument called **Spectrophotometer** is used to measure relative abilities of different pigments to absorb different wavelengths of light. A graph plotting absorption of light of different wave lengths by a pigment is called **absorption spectrum** of the pigment.

Thylakoid membranes contain several kinds of pigments, but **chlorophylls** are the main photosynthetic pigments. Other, accessory photosynthetic pigments present in the chloroplasts include yellow and red to orange **carotenoids**; **carotenes** are mostly red to orange and **xanthophylls** are yellow to orange. These broaden the absorption and utilization of light energy.

Chlorophylls

There are known many different kinds of chlorophylls. Chlorophyll a, b, c and d are found in eukaryotic photosynthetic plants and algae, while the other are found in photosynthetic bacteria and are known as **bacteriochlorophylls**.

Chlorophylls absorb mainly violet-blue and orange-red wave lengths. Green, yellow and indigo wave lengths are least absorbed by chlorophylls and are transmitted or reflected, although the yellows are often masked by darker green colour. Hence plants appear green, unless masked by other pigments (Fig. 11.4).

A chlorophyll molecule has two main parts : One flat, square, light absorbing hydrophilic head and the other long, anchoring, hydrophobic hydrocarbon tail. The head is complex **porphyrin ring** which is made up of 4 joined smaller pyrrole rings composed of carbon and nitrogen atoms. An atom of magnesium is present in the centre of porphyrin ring and is coordinated with the nitrogen of each pyrrole ring (Fig. 11.2) That is why magnesium deficiency causes yellowing in plants.

Haem portion of haemoglobin is also a porphyrin ring but containing an iron atom instead of magnesium atom in the centre.

Long hydrocarbon tail which is attached to one of the pyrrole rings is **phytol** ($C_{20}H_{39}$). The chlorophyll molecule is embedded in the hydrophobic core of thylakoid membrane by this tail.

Chlorophyll a and chlorophyll b differ from each other in only one of the functional groups bonded to the porphyrin; the methyl group ($-CH_3$) in chlorophyll a is replaced by a terminal carbonyl group ($-CHO$) in chlorophyll b.

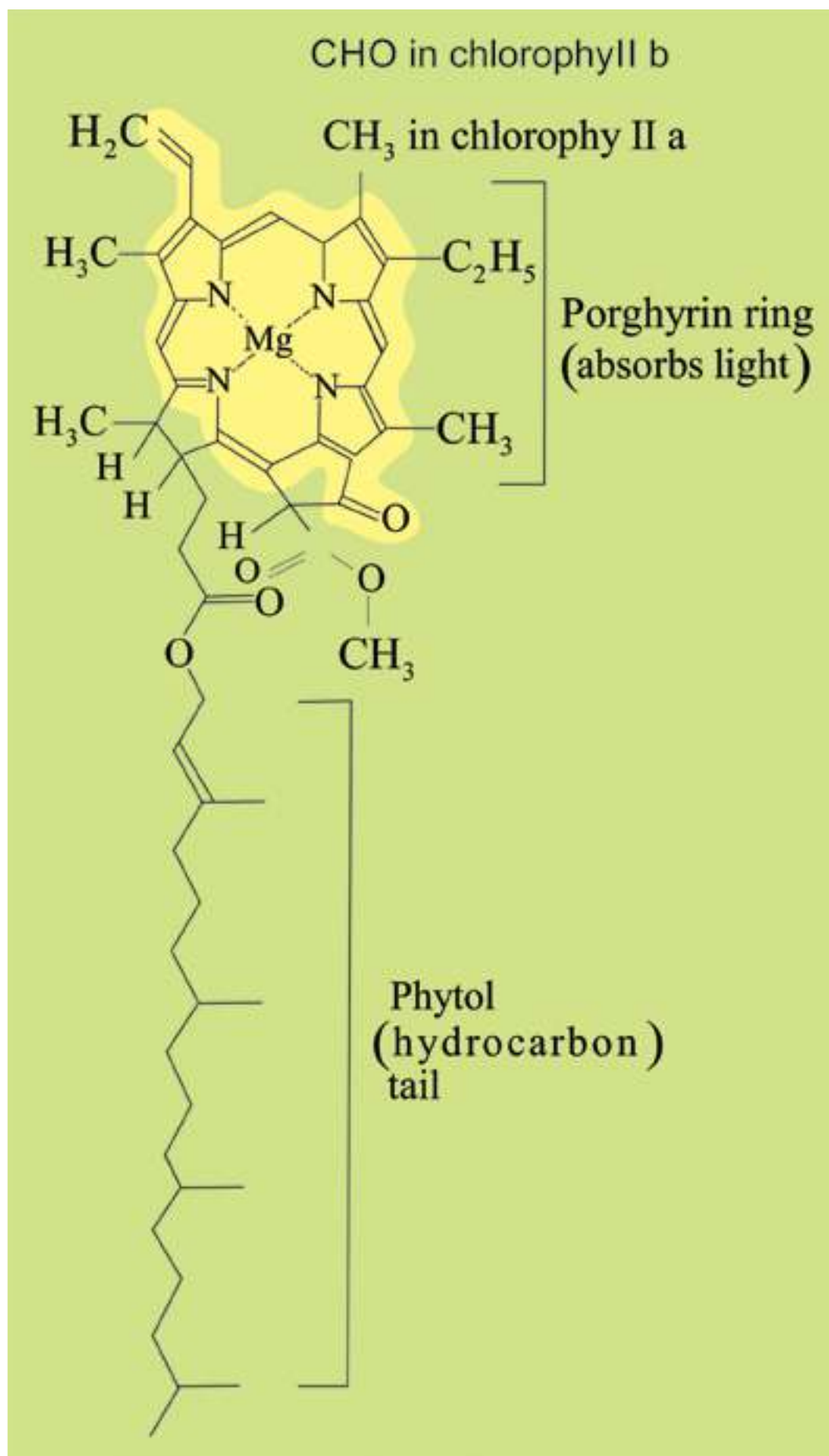
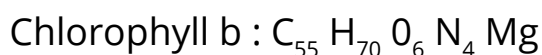

Fig. 11.2 A molecule of chlorophyll

The molecular formulae for chlorophyll a and b are:



Due to this slight difference in their structure, the two chlorophylls show slightly different absorption spectra and hence different colours. Some wave lengths not absorbed by chlorophyll a are very effectively absorbed by chlorophyll b and vice-versa. Such differences in structure of different pigments increase the range of wave lengths of the light absorbed. Chlorophyll a is blue-green while chlorophyll b is yellow-green.

Of all the chlorophylls, chlorophyll a is the-most abundant and the most important photosynthetic pigment as it takes part directly in the light-dependent reactions which convert solar energy into chemical energy. It is found in all photosynthetic organisms except photosynthetic bacteria. Chlorophyll a itself exists in several forms differing slightly in their red absorbing peaks e.g. at 670, 680, 690, 700 nm.

Chlorophyll b is found alongwith chlorophyll a in all green plants (embryophytes) and green algae.

Chlorophylls are insoluble in water but soluble in organic solvents, such as carbon tetrachloride, alcohol etc.

Carotenoids-accessory pigments

Carotenoids are yellow and red to orange pigments that absorb strongly the blueviolet range, different wave lengths than the chlorophyll absorbs. So they broaden the spectrum of light that provides energy for photosynthesis.

These and chlorophyll b are called **accessory pigments** because they absorb light and transfer the energy to chlorophyll a, which then initiates the light reactions. It is generally believed that the order of transfer of energy is:



Some carotenoids protect chlorophyll from intense light by absorbing and dissipating excessive light energy, rather than transferring energy to chlorophyll. (Similar carotenoids may be protecting human eye).

LIGHT-THE DRIVING ENERGY

Light is a form of energy called electromagnetic energy or radiations. Light behaves as waves as well as sort of particles called **photons**. The radiations most important to life are the **visible light** that ranges from about 380 to 750 nm in wave length.

It is the sunlight energy that is absorbed by chlorophyll, converted into chemical energy, and drives the photosynthetic process. Not all the light falling on the leaves is absorbed. Only about one percent of the light falling on the leaf surface is absorbed, the rest is reflected or transmitted.

Absorption spectrum for chlorophylls (Fig. 11.4) indicates that absorption is maximum in blue and red parts of the spectrum, two absorption peaks being at around 430 nm and 670 nm respectively. Absorption peaks of carotenoids are different from those of chlorophylls.

Different wavelengths are not only differently absorbed by photosynthetic pigments but are also differently effective in photosynthesis. Graph showing relative effectiveness of different wavelengths (colours) of light in driving photosynthesis is called **action spectrum** of photosynthesis (Fig. 11.4)

The first action spectrum was obtained by German biologist, T.W.Engelmann in 1883. He worked on Spirogyra.

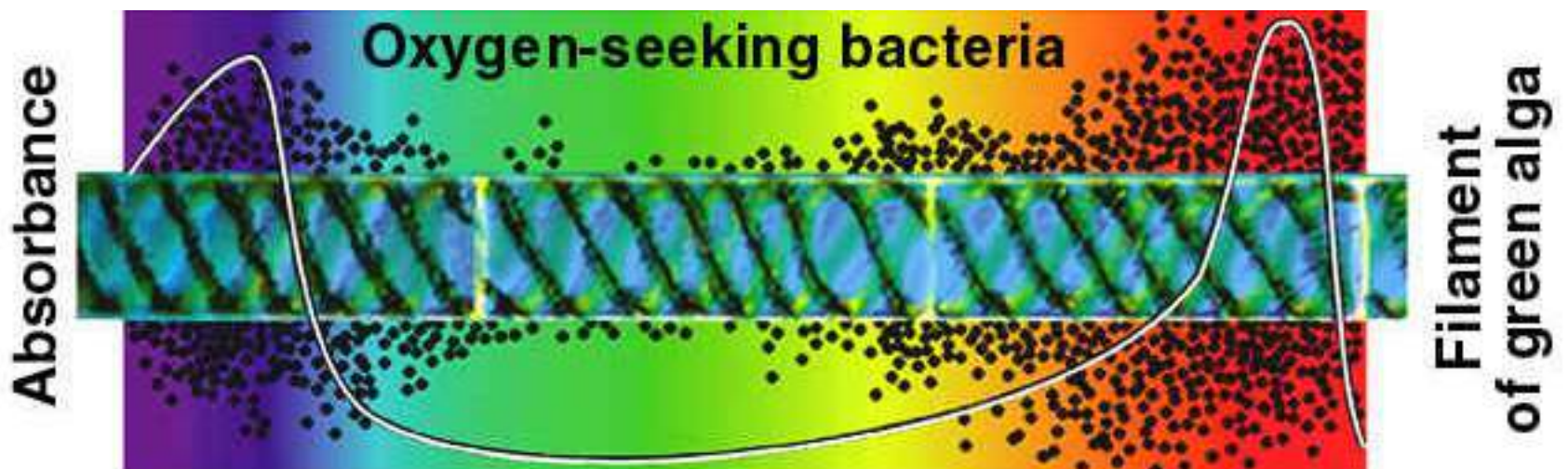

Fi.g 11.3 Engel man illuminated a filament of Spirogyra with light that had been passed through a prism. Aerobic bacteria moved toward the portions of the algal filament emitting the most oxygen, along the cells in blue and red portion of the spectrum.

Action spectrum can be obtained by illuminating plant with light of different wavelengths (or colours) and then estimating relative CO₂ consumption or oxygen release during photosynthesis.

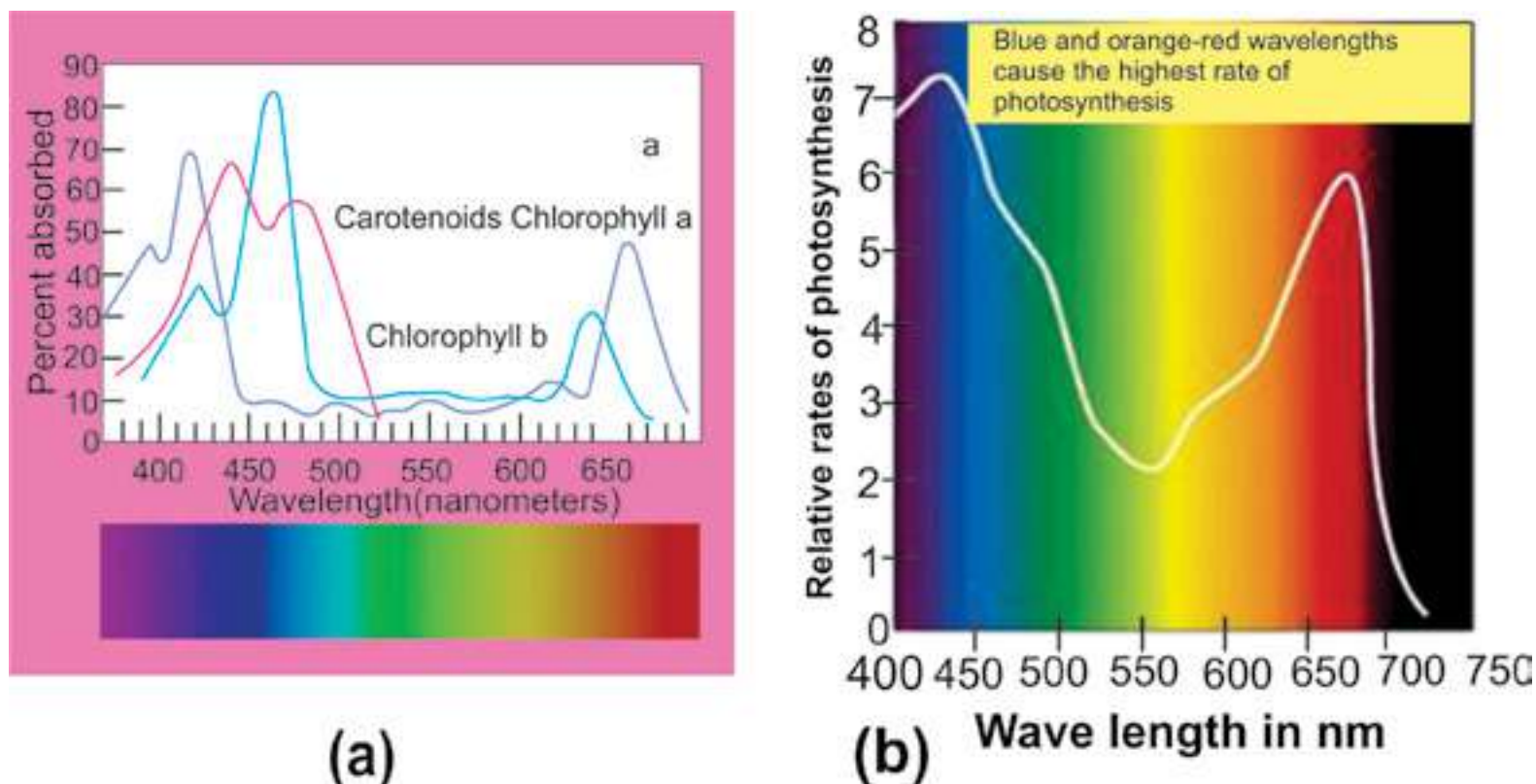

Fig. 11.4 (a) Absorption spectrum of chlorophyll and carotenoids.
(b) Action spectrum for photosynthesis.

As is evident from above figure 11.4, action spectrum of photosynthesis corresponds to absorption spectrum of chlorophyll. The same two peaks and the valley are obtained for absorption of light as well as for CO₂ consumption. This also shows that chlorophyll is the photosynthetic pigment.

However, the action spectrum of photosynthesis does not parallel the absorption spectrum of chlorophyll exactly. Compared to the peaks in absorption spectrum, the peaks in action spectrum are broader, and the valley is narrower and not as deep.

(Photosynthesis in the most absorbed range is more than the absorption itself. Likewise, photosynthesis in 500-600 nm (including green light) is more than the absorption of green light by the chlorophyll). This difference occurs because the accessory pigments, the carotenoids, absorb light in this zone and pass on some of the absorbed light to chlorophylls which then convert light energy to chemical energy. When equal intensities of light are given, there is more photosynthesis in red than in blue part of spectrum.

ROLE OF CARBON DIOXIDE : A PHOTOSYNTHETIC REACTANT

Sugar is formed during **light - independent reactions** of photosynthesis by the reduction of CO_2 , using ATP and NADH, the products of **light - dependent reactions**. Obviously photosynthesis does not occur in the absence of CO_2 .

About 10 percent of total photosynthesis is carried out by terrestrial plants, the rest occurs in oceans, lakes and ponds. Aquatic photosynthetic organisms use dissolved CO_2 , bicarbonates and soluble carbonates that are present in water as carbon source. Air contains about 0.03 - 0.04 percent CO_2 . Photosynthesis occurring on land utilizes this atmospheric CO_2 .

Carbondioxide enters the leaves through **stomata** and gets dissolved in the water absorbed by the cell walls of mesophyll cells. Stomata are found in a large number in a leaf; their number being proportional to the amount of gas diffusing into the leaf. Stomata cover only 1 - 2 percent of the leaf surface but they allow proportionately much more gas to diffuse.

The entry of CO_2 into the leaves depends upon the opening of stomata. The guard cells guarding the stoma, because of their peculiar structure and changes in their shape, regulate the opening and closing of stomata.

Stomata are adjustable pores that are usually open during the day when CO_2 is required for photosynthesis and partially closed at night when photosynthesis stops.

Daily rhythmic opening and closing of stomata is also due to an internal clock located in the guard cells. Even if a plant is kept in a dark closet, stomata will continue their daily rhythm of opening and closing.

REACTIONS OF PHOTOSYNTHESIS

Photosynthesis is a '**redox process**' that can be represented by the following simplified summary equation:

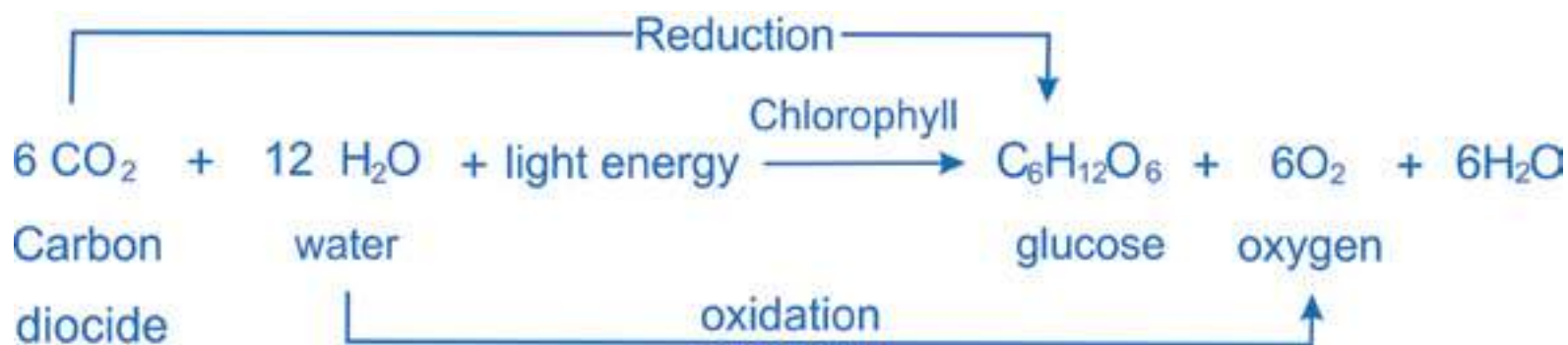

However, it is not a simple, single step process, but is a complex one that is completed by a series of simple steps or reactions. These reactions of photosynthesis consist of two parts:

The light-dependent reactions (light reactions) which use light directly and

The light-independent reactions (dark reactions) which do not use light directly.

Light dependent reactions constitute that phase of photosynthesis during which light energy is absorbed by chlorophyll and other photosynthetic pigment molecules and converted into chemical energy. As a result of this energy conversion, **reducing** and **assimilating power** in the form of NADPH (NADPH + H⁺) and ATP, are formed, both temporarily storing energy to be carried along with H to the light independent reactions.

NADPH provides energized electron (and H⁺), while ATP provides chemical energy for the synthesis of sugar by reducing CO₂, using reducing power and chemical energy of NADPH and ATP respectively, produced by light reactions. The energy is thus stored in the molecules of sugar. This phase of photosynthesis is also called **dark reactions** because these reactions do not use light directly and can take place equally well both in light and dark provided NADPH₂ and ATP of light reactions are available.

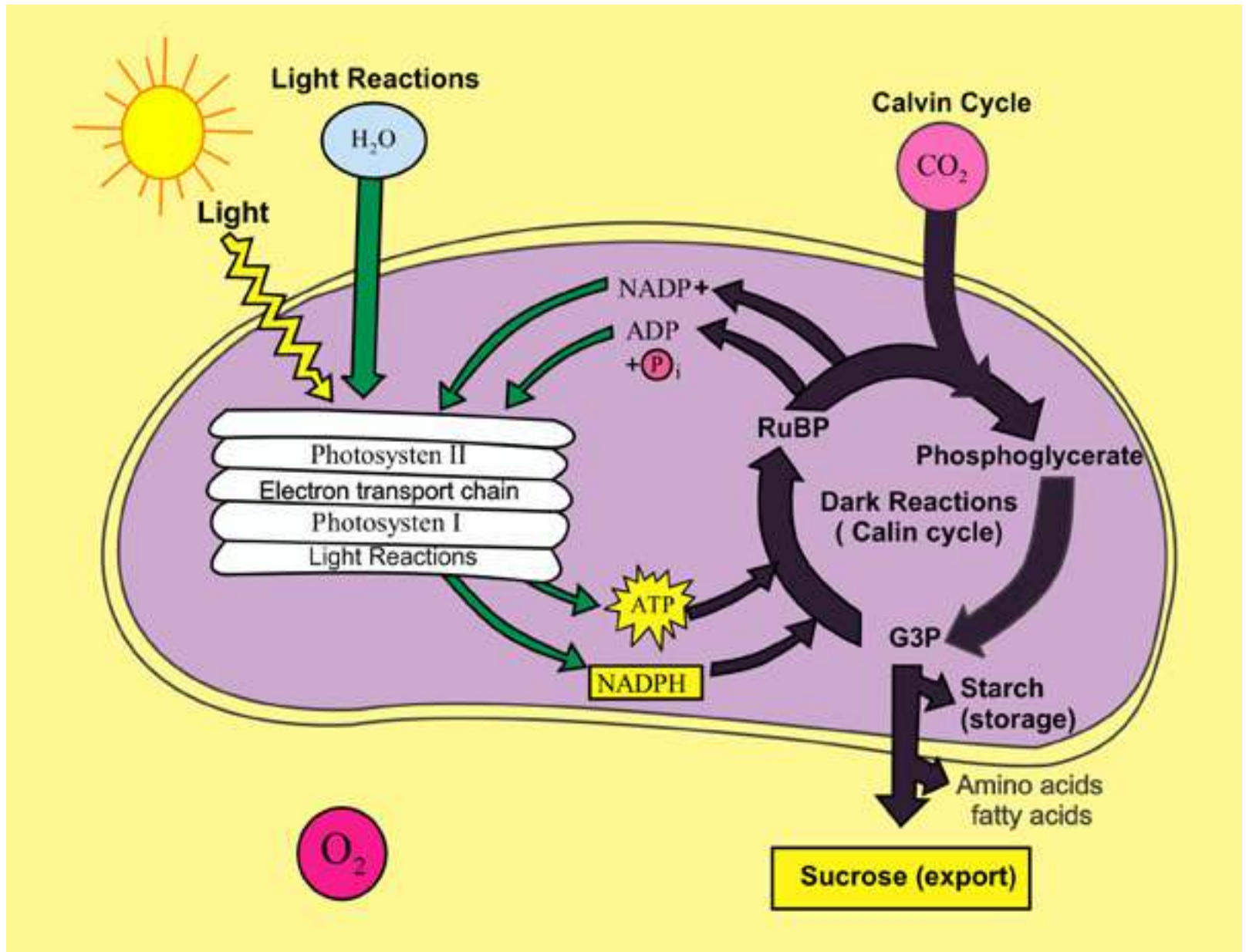

Fig. 11.5 An overview of photosynthesis : Light - Dependent Reactions (Energy - conversion) and Light - Independent Reactions (Energy - conservation)

Light dependent Reactions

(Energy-conversion phase; formation of ATP and NADPH)

As has been described previously, sunlight energy which is absorbed by photosynthetic pigments drives the process of photosynthesis. Photosynthetic pigments are organized into clusters, called **photosystems**, for efficient absorption and utilization of solar energy in thylakoid membranes (Fig. 11.6).

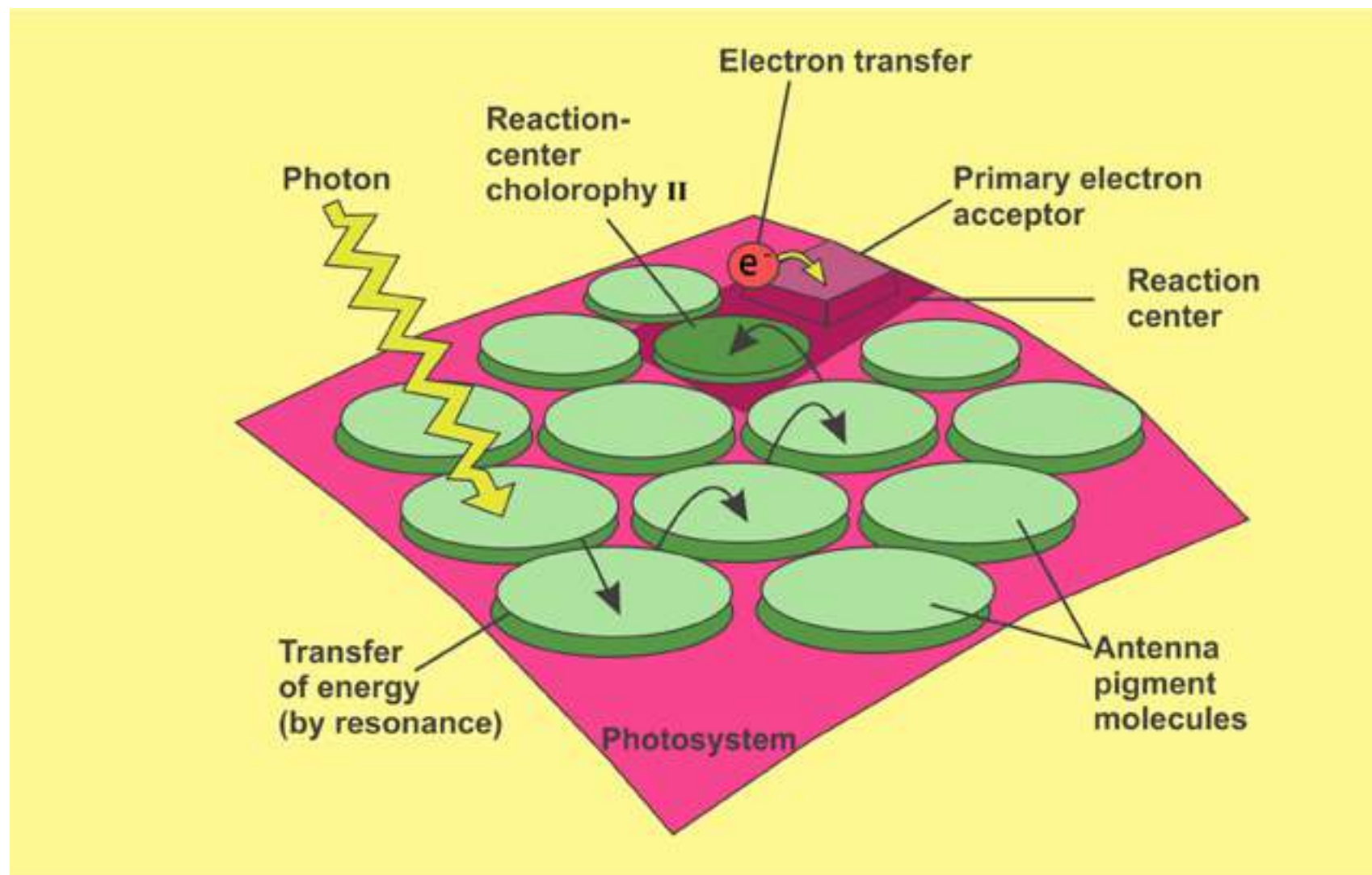

Fig. 11.6: Light harvesting photosystem. Energy of light (photon) absorbed by photosynthetic pigment molecules is transferred from molecule to molecule, and finally reaches the reaction centre where actual energy conversion begins.

Each **photosystem** consists of a light-gathering '**antenna complex**' and a '**reaction center**'. The antenna complex has many molecules of chlorophyll a, chlorophyll b and carotenoids, most of them channeling the energy to reaction center. Reaction center has one or more molecules of chlorophyll a along with a **primary electron acceptor**, and associated electron carriers of '**electron transport system**'. Chlorophyll a molecules of reaction center and associated proteins are closely linked to the nearby electron transport system. Electron transport system plays role in generation of ATP by **chemiosmosis** (which will be discussed in later section). Light energy absorbed by the pigment molecules of antenna complex is transferred ultimately to the reaction center. There the light energy is converted into chemical energy.

There are two photosystems, **photosystem I (PS I)** and **photosystem II (PS II)**. These are named so in order of their discovery. **Photosystem I** has chlorophyll a molecule which absorbs maximum light of 700 nm and is called P_{700} , whereas reaction center of photosystem II has P_{680} , the form of chlorophyll a which absorbs best the light of 680 nm. A specialized molecule called, **primary electron acceptor** is also associated nearby each reaction center. This acceptor traps the high energy electrons from the reaction center and then passes them on to the series of electron carriers. During this energy is used to generate ATP by chemiosmosis.

In predominant type of electron transport called **non-cyclic electron flow**, the electrons pass through the two photosystems. In less common type of path called **cyclic electron flow** only photosystem I is involved. Formation of ATP during non-cyclic electron flow is called **non-cyclic phosphorylation** while that during cyclic electron flow is called **cyclic phosphorylation**.

Non-cyclic Phosphorylation

1. When photosystem II absorbs light, an electron excited to a higher energy level in the reaction center chlorophyll P_{680} is captured by the primary electron acceptor of PS II. The oxidized chlorophyll is now a very strong oxidizing agent; its electron "hole" must be filled.
2. This hole is filled by the electrons which are extracted, by an enzyme, from water. This reaction splits a water molecules into two hydrogen ions and an oxygen atom, which immediately combines with another oxygen atom to form O_2 . This water splitting step of photosynthesis that releases oxygen is called **photolysis**. The oxygen produced during photolysis is the main source of replenishment of atmospheric oxygen.
3. Each photoexcited electron passes from the primary electron acceptor of photosystem II to photosystem I via an **electron transport chain**. This chain consists of an electron carrier called

plastoquinone (Pq), a complex of two cytochromes and a copper containing protein called **plastocyanin** (Pc).

4. As electrons move down the chain, their energy goes on decreasing and is used by thylakoid membrane to produce ATP. This ATP synthesis is called **photophosphorylation** because it is driven by light energy. Specifically, ATP synthesis during non-cyclic electron flow is called **non-cyclic photophosphorylation**. This ATP generated by the light reactions will provide chemical energy for the synthesis of sugar during the Calvin cycle, the second major stage of photosynthesis.
5. The electron reaches the “bottom” of the electron transport chain and fills an electron “hole” in P_{700} , the chlorophyll a molecules in the reaction center of photosystem I. This hole is created when light energy is absorbed by molecules of P_{700} and drives an electron from P_{700} to the primary acceptor of photosystem I.
6. The primary electron acceptor of photosystem I passes the photoexcited electrons to a second electron transport chain, which transmits them to **ferredoxin (Fd)**, an iron containing protein. An enzyme called NADP reductase then transfers the electrons from **Fd** to **NADP**. This is the redox reaction that stores the high-energy electrons in NADPH. The NADPH molecule will provide reducing power for the synthesis of sugar in the Calvin cycle.

The path of electrons through the two photosystems during non-cyclic photophosphorylation is known as **Z-scheme** from its shape.

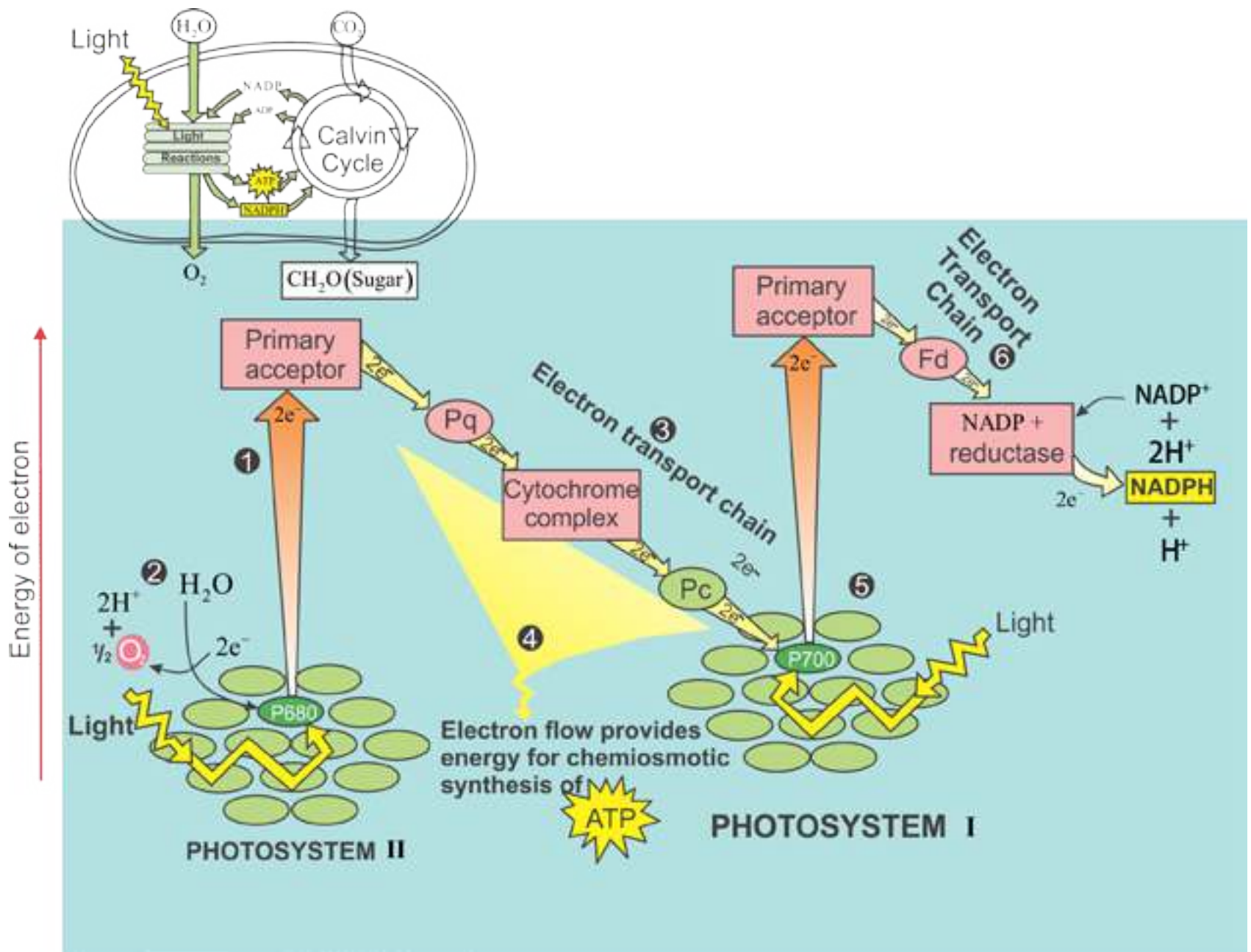

Fig 11.7: Non-cyclic electron flow during photosynthesis ATP, NADPH and oxygen are generated. The arrows trace the current of light-driven electrons from water to NADPH. Each photon of light excites single electron, but the diagram tracts two electrons at a time, the number of electrons required to reduce $NADP^+$. The numbered steps are described in the text.

Chemiosmosis

In both cyclic and non-cyclic photophosphorylation, the mechanism for ATP synthesis is **chemiosmosis**, the process that uses membranes to couple redox reactions to ATP production. Electron transport chain pumps protons (H^+) across the membrane of thylakoids in case of photosynthesis into the thylakoids space. The energy used for this pumping comes from the electrons moving through the electron transport chain. This energy is transformed into potential energy stored in the form of H^+ gradient across the membrane. Next the hydrogen ions move down their gradient through special complexes called **ATP synthase** which are built in the thylakoid membrane. During this diffusion of H^+ the energy of electrons is used to make ATP (Fig. 11.9).

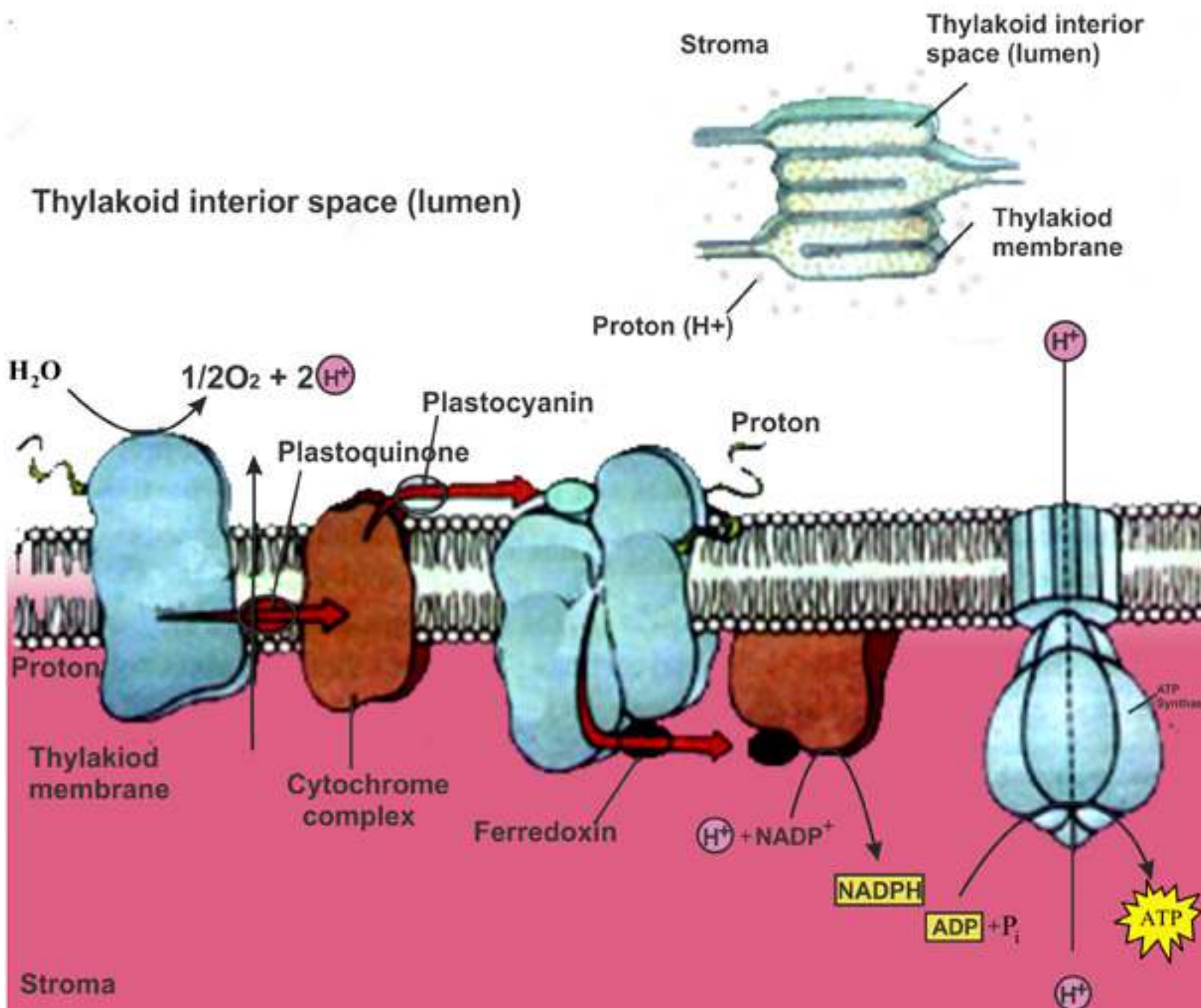
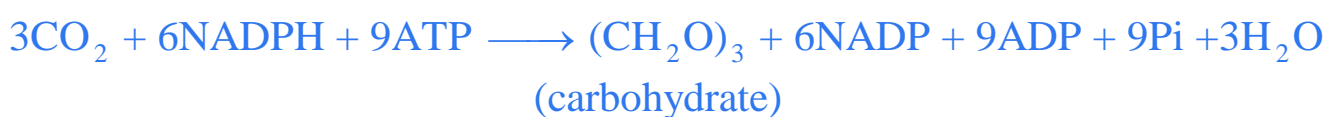

Fig. 11.9 Electron Transport chain and chemiosmosis, coupling of ETC and formation of ATP by chemiosmosis.

Light independent (or Dark) Reactions

Calvin cycle : carbon fixation and reduction phase, synthesis of sugar

The **dark reactions** take place in the stroma of chloroplast. These reactions do not require light directly and can occur in the presence or absence of light provided the assimilatory power in the form of ATP and NADPH, produced during light reactions is available. Energy of these compounds is used in the formation of carbohydrates from CO₂, and thus stored their in. These reactions can be summarised as follows (Fig. 11.10):



The details of path of carbon in these reactions were discovered by Melvin Calvin and his colleagues at the University of California. Calvin was awarded Nobel Prize in 1961.

The cyclic series of reactions, catalyzed by respective enzymes, by which the carbon is fixed and reduced resulting in the synthesis of sugar during the dark reactions of photosynthesis is called **Calvin Cycle**.

The **Calvin cycle** can be divided into three phases: Carbon fixation, Reduction, and Regeneration of CO₂ acceptor (RuBP) (Fig 11.10).

Phase 1: Carbon fixation: Carbon fixation refers to the initial incorporation of CO₂ into organic material. Keep in mind that we are following three molecules of CO₂ through the reaction (because 3 molecules of CO₂ are required to produce one molecule of carbohydrate, a triose). The Calvin cycle begins when a molecule of CO₂ reacts with a highly reactive phosphorylated five - carbon sugar named **ribulose biphosphate (RuBP)**. This reaction is catalyzed by the **enzyme ribulose biphosphate carboxylase**, also known as Rubisco (it is the most abundant protein in chloroplasts, and probably the most abundant protein on Earth). The product of this reaction is an highly unstable, six - carbon intermediate that immediately breaks into two molecules of three - carbon compound called **3 - phosphoglycerate (phosphoglyceric acid-PGA)**. The carbon that was originally part of CO₂ molecule is now a part of an organic molecule; the carbon has been “fixed”. Because the product of initial carbon fixation is a three - carbon compound, the Calvin cycle is also known as **C₃ pathway**.

Phase 2: Reduction: Each molecule of (PGA) receives an additional phosphate from ATP of light reaction, forming **1,3 - bisphosphoglycerate** as the product. 1,3 bisphosphoglycerate is reduced to **glyceraldehyde 3-phosphate(G3P)** by receiving a pair of electrons donated from NADPH of light reactions. G3P is the same three-carbon sugar which is formed in glycolysis (first phase of cellular respiration) by the splitting of glucose. In this way fixed carbon is reduced to energy rich G3P with the energy and reducing power of ATP and NADPH (both the products of light-dependent reactions), having the energy stored in it. Actually **G3P**, and not glucose, is the carbohydrate produced directly from the Calvin cycle. For every three molecules of CO_2 entering the cycle and combining with 3 molecules of five-carbon RuBP, six molecules of G3P (containing 18 carbon in all) are produced. But only one molecule of G3P can be counted as a net gain of carbohydrate. Out of every six molecules of G3P formed, only one molecule leaves the cycle to be used by the plant for making glucose, sucrose starch or other carbohydrates, and other organic compounds; the other five molecules are recycled to regenerate the three molecules of five-carbon RuBP, the CO_2 acceptor.

Phase 3: Regeneration of CO_2 acceptor, RuBP: Through a complex series of reactions, the carbon skeletons of five molecules of three-carbon G3P are rearranged into three molecules of **five-carbon ribulose phosphate (RuP)**. Each RuP is phosphorylated to ribulose bisphosphate (RuBP), the very five-carbon CO_2 acceptor with which the cycle started. Again three more molecules of ATP of light reactions are used for this phosphorylation of three RuP molecules. These RuBP are now prepared to receive CO_2 again, and the cycle continues.

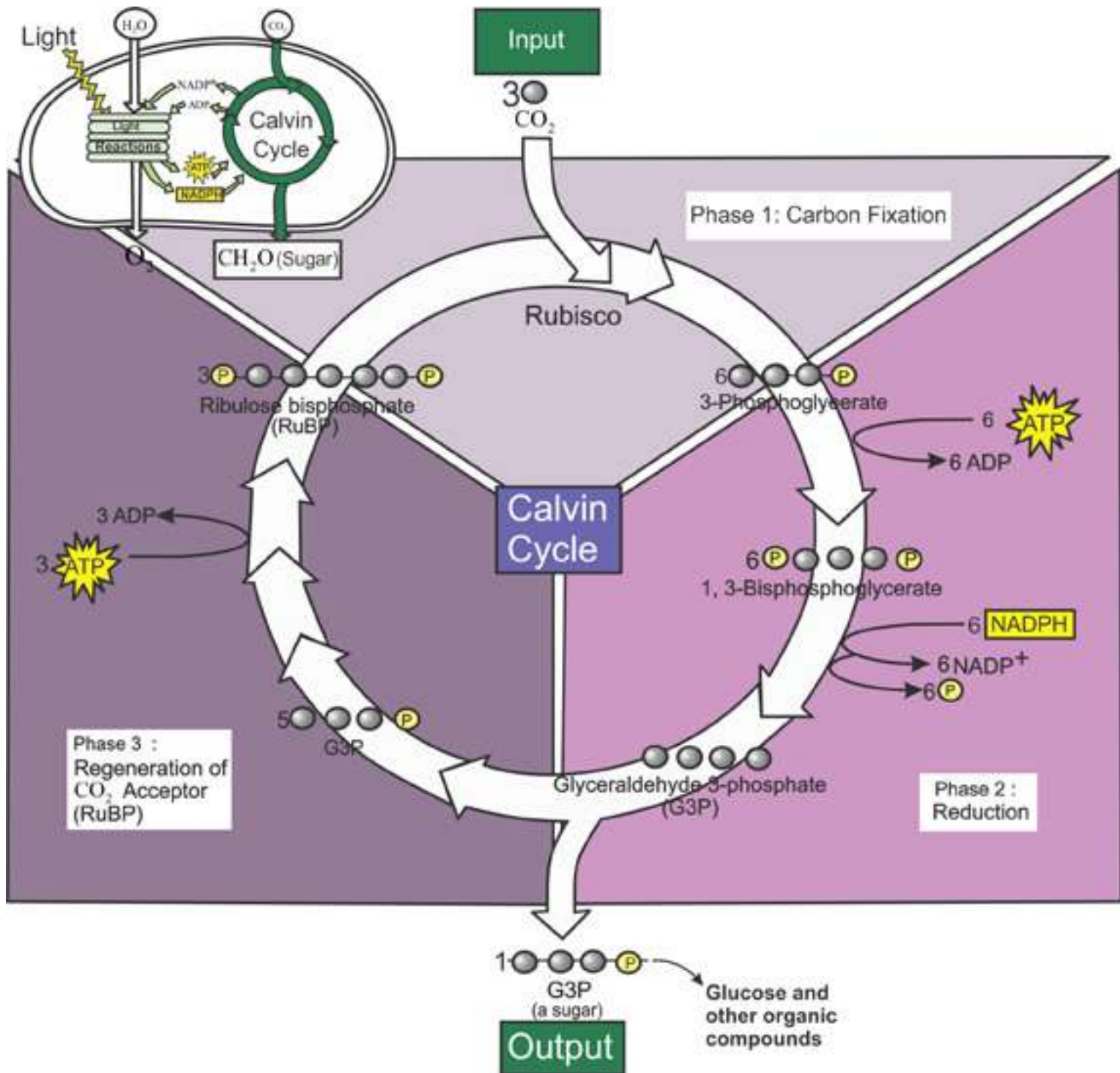

Fig. 11.10: The Calvin cycle occurs in stroma of chloroplast. Carbon is fixed and reduced to sugar.

RESPIRATION

Living organisms need energy to carry on their vital activities. This energy is provided from within the cells by the phenomenon of respiration. Respiration is the universal process by which organisms breakdown complex compounds containing carbon in a way that allows the cells to harvest a maximum of usable energy.

In biology the term respiration is used in two ways. More familiarly the term respiration means the exchange of respiratory gases (CO_2 and O_2) between the organism and its environment. This exchange is called **external respiration**. The cellular respiration is the process by which energy is made available to cells in a step by step breakdown of C-chain molecules in the cells.

Aerobic and Anaerobic Respiration

The most common fuel used by the cell to provide energy by cellular respiration is glucose,. The way glucose is metabolized depends on the availability of oxygen. Prior to entering a mitochondrion, the glucose molecule is split to form two molecules of pyruvic acid. This reaction is called **glycolysis** (glycolysis literally means splitting of sugar), and occurs in the cytosol and is represented by the equation:

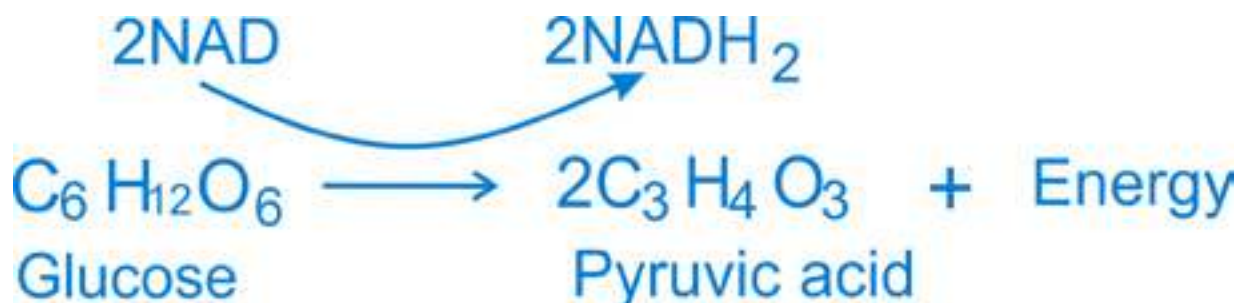

This reaction occurs in all the cells and biologists believe that an identical reaction may have occurred in the first cell that was organized on earth.

The next step in cellular respiration varies depending on the type of the cell and the prevailing conditions (Fig. 11.11).

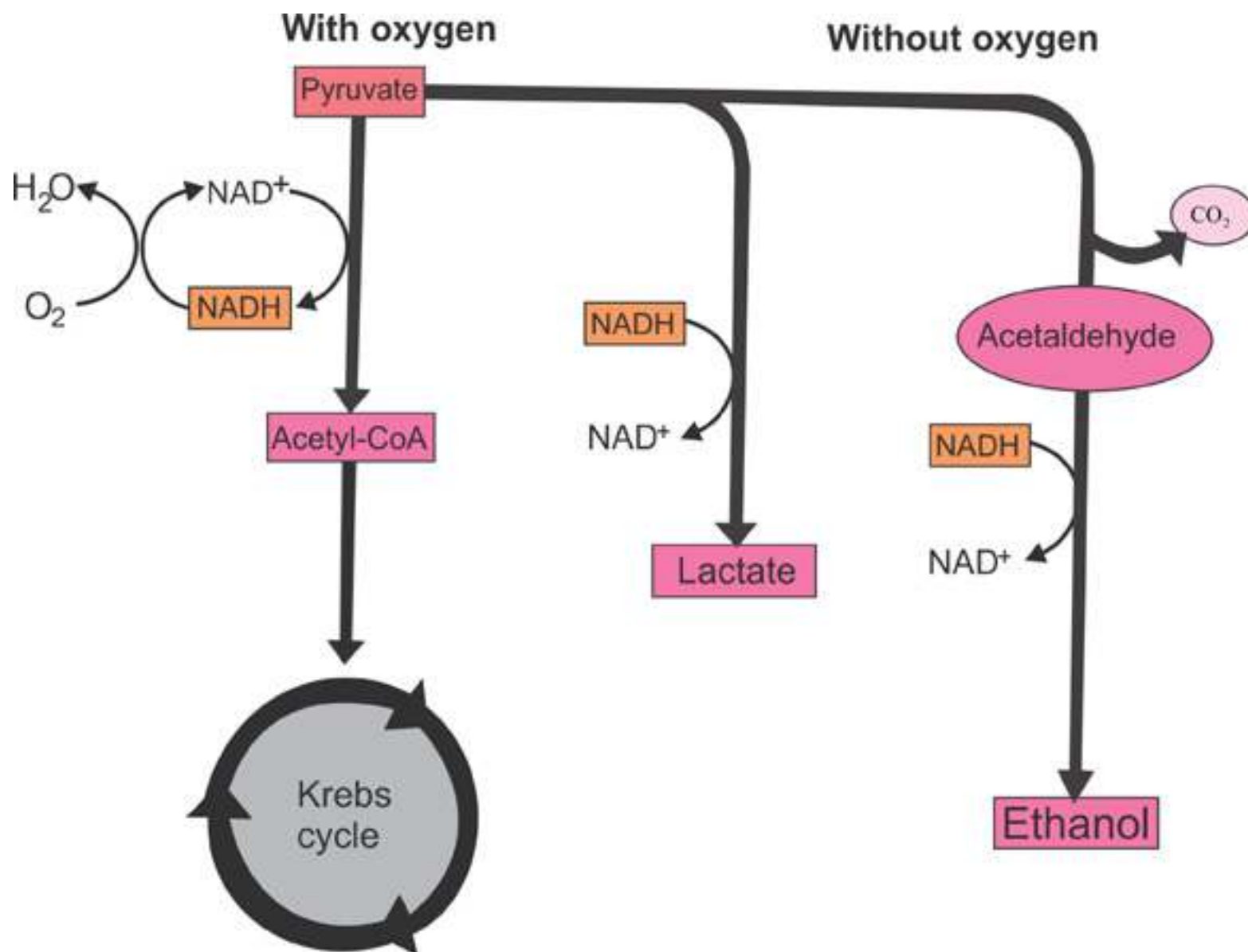
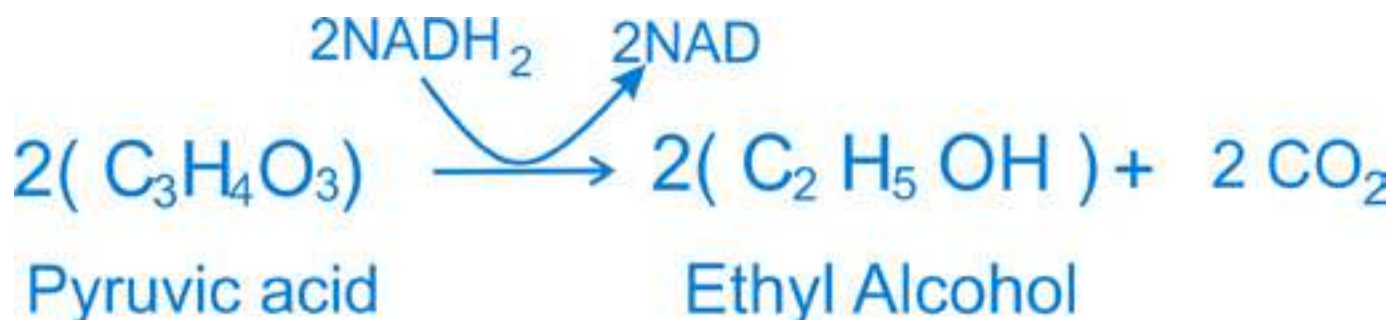

Fig. 11.11 Pyruvate, the end product of glycolysis, follows different catabolic pathways depending on the organism and the metabolic condition.

Cell processes pyruvic acid in three major ways, alcoholic fermentation, lactic acid fermentation and aerobic respiration. The first two reactions occur in the absence of oxygen and are referred to as anaerobic (without oxygen). The complete breakdown of glucose molecule occurs only in the presence of oxygen, i.e. in aerobic respiration. During aerobic respiration glucose is oxidized to CO₂ and water and energy is released.

Anaerobic Respiration

(i) **Alcoholic Fermentation:** In primitive cells and in some eukaryotic cells such as yeast, pyruvic acid is further broken down by alcoholic fermentation into alcohol (C_2H_5OH) and CO_2 .



(ii) **Lactic acid fermentation:** In lactic acid fermentation, each pyruvic acid molecule is converted into lactic acid $C_3H_6O_3$ in the absence of oxygen gas:

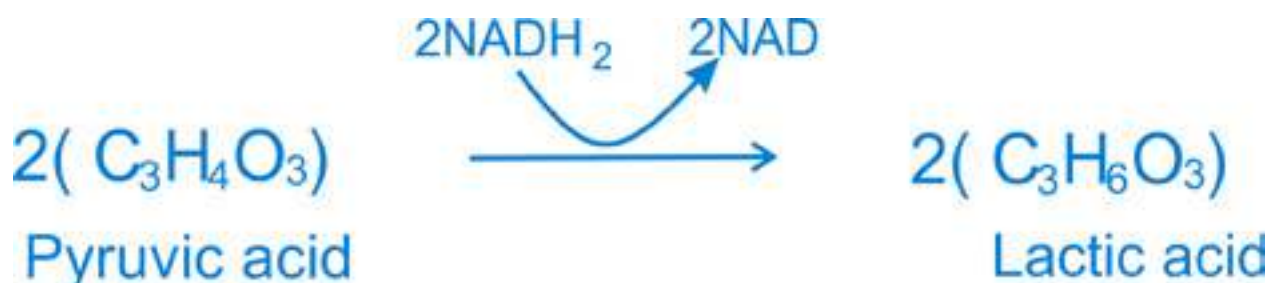

This form of anaerobic respiration occurs in muscle cells of humans and other animals during extreme physical activities, such as sprinting, when oxygen cannot be transported to the cells as rapidly as it is needed.

Both alcoholic and lactic acid fermentations yield relatively small amounts of energy from glucose molecule. Only about 2% of the energy present within the chemical bonds of glucose is converted into adenosine triphosphate (ATP).

Aerobic respiration (Discussed in detail under cellular respiration).

Role of mitochondria in respiration Mitochondria are large granular or filamentous organelles that are distributed throughout the cytoplasm of animal and plant cells. Each mitochondrion is constructed of an outer enclosing membrane and an inner membrane with elaborate folds or **cristae** that extend into the interior of the organelle.

Mitochondria play a part in cellular respiration by transferring the energy of the organic molecules to the chemical bonds of ATP. A large "battery" of enzymes and coenzymes slowly release energy

from the glucose molecules. Thus mitochondria are the “**Power houses**” that produce energy necessary for many cellular functions.

Adenosine triphosphate and its importance Adenosine triphosphate, generally abbreviated ‘ATP’ is a compound found in every living cell and is one of the essential chemicals of life. It plays the key role in most biological energy transformations.

Conventionally, ‘P’ stands for the entire phosphate group. The second and the third phosphate represent the so called “high energy” bonds. If these are broken by hydrolysis, far more free energy is released as compared to the other bond in the ATP molecule. The breaking of the terminal phosphate of ATP releases about 7.3 K cal. of energy. The high energy ‘P’ bond enables the cell to accumulate a great quantity of energy in a very small space and keeps it ready for use as soon as it is needed.

The ATP molecule is used by cells as a source of energy for various functions for example, synthesis of more complex compounds, active transport across the cell membrane, muscular contraction, and nerve conduction, etc.

Biological oxidation The maintenance of living system requires a continual supply of free energy which is ultimately derived from various oxidation reduction reactions. Except for photosynthetic and some bacterial chemosynthetic processes, which are themselves oxidation reduction reactions, all other cells depend ultimately for their supply of free energy on oxidation reactions in respiratory processes. In some cases biological oxidation involves the removal of hydrogen, a reaction catalyzed by the **dehydrogenases** linked to specific coenzymes. Cellular respiration is essentially an oxidation process.

Cellular Respiration

Cellular respiration may be sub-divided into 4 stages:

- | | |
|---------------------------------------|----------------------------|
| i. Glycolysis | ii. Pyruvic acid oxidation |
| iii. Krebs cycle or citric acid cycle | iv. Respiratory chain |

Out of these stages the first occurs in the cytosol for which oxygen is not essential, while the other three occur within the mitochondria where the presence of oxygen is essential.

- i. **Glycolysis** Glycolysis is the breakdown of glucose upto the formation of pyruvic acid. Glycolysis can take place both in the absence of oxygen (anaerobic condition) or in the presence of oxygen (aerobic condition). In both, the end product of glucose breakdown is **pyruvic acid**. The breakdown of glucose takes place in a series of steps, each catalyzed by a specific enzyme. All these enzymes are found dissolved in the cytosol. In addition to the enzymes, ATP and **coenzyme NAD (nicotinamide adenine dinucleotide)** are also essential.

Glycolysis can be divided into two phases, a preparatory phase and an oxidative phase (Fig. 11.12). In the preparatory phase breakdown of glucose occurs and energy is expended. In the oxidative phase high energy phosphate bonds are formed and energy is stored.

Preparatory phase The first step in glycolysis is the transfer of a phosphate group from ATP to glucose. As a result a molecule of glucose-6 -phosphate is formed. An enzyme catalyzes the conversion of **glucose-6-phosphate** to its isomer, **fructose-6 - phosphate**. At this stage another ATP molecule transfers a second phosphate group. The product is fructose 1,6-bisphosphate. The next step in glycolysis is the enzymatic splitting of fructose 1 ,6 -bisphosphate into two fragments. Each of these molecules contains three carbon atoms. One is called 3 - phospo- glyceraldehyde, 3-PGAL or Glyceraldehyde **3-phosphate (G3P)** while the other is **dihydroxyacetone phosphate**. These two molecules are isomers and in fact, are readily interconverted by yet another enzyme of glycolysis.

Oxidative (payoff) phase The next step in glycolysis is crucial to this process. Two electrons or two hydrogen atoms are removed from the molecule of 3- phosphoglyceraldehyde (PGAL) and transferred to a molecule of NAD. This is of course, an oxidation-reduction reaction, with the PGAL being oxidized and the NAD being reduced. During this reaction, a second phosphate group is donated to the molecule from inorganic phosphate present in the cell. The resulting molecule is called **1,3 Bisphosphoglycerate(BPG)**.

The oxidation of PGAL is an energy yielding process. Thus a "high energy" phosphate bond is created in this molecule. At the very next step in glycolysis this phosphate group is transferred to a molecule of adenosine diphosphate (ADP) converting it into ATP. The end product of this reaction is **3-phospho glycerate (3-PG)**. In the next step 3-PG is converted to **2-Phosphoglycerate (2PG)**. From 2PG a molecule of water is removed and the product is **phosphoenol pyruvate (PEP)**. PEP then gives up its 'high energy' phosphate to convert a second molecule of ADP to ATP. The product is pyruvate, pyruvic acid ($C_3 H_4 O_3$). It is equivalent to half glucose molecule that has been oxidized to the extent of losing two electrons (as hydrogen atoms).

ii. Pyruvic acid oxidation: Pyruvic acid (pyruvate), the end product of glycolysis, does not enter the Krebs cycle directly. The pyruvate (3- carbon molecule) is first changed into 2-carbon acetic acid molecule. One carbon is released as CO_2 (decarboxylation). Acetic acid on entering the mitochondrion unites with coenzyme-A (Co A) to form acetyl Co A (active acetate). In addition, more hydrogen atoms are transferred to NAD (Fig. 11.13).

iii. Krebs cycle or citric acid cycle: Acetyl CoA now enters a cyclic series of chemical reactions during which oxidation process is completed. This series of reactions is called the Krebs cycle (after the name of the biochemist who discovered it), or the citric acid cycle. The first step in the cycle is the union of acetyl CoA with oxaloacetate to form citrate. In this process, a molecule of CoA is regenerated and one molecule of water is used. Oxaloacetate is a 4-carbon acid. Citrate thus has 6 carbon atoms.

After two steps that simply result in forming an isomer of citrate, isocitrate another NAD- mediated oxidation takes place. This is accompanied by the removal of a molecule of CO_2 . The result is **α -ketoglutarate**. It, in turn, undergoes further oxidation ($\text{NAD} + 2\text{H} \rightarrow \text{NADH}$) followed by decarboxylation (CO_2) and addition of a molecule of water. The product then has one carbon atom and one oxygen atom less. It is **succinate**. The conversion of α -ketoglutarate into succinate is accompanied by a free energy change which is utilised in the synthesis of an ATP molecule. The next step in the Krebs cycle is the oxidation of succinate to **fumarate**. Once again, two hydrogen atoms are removed, but this time the oxidizing agent is a coenzyme called **flavin adenine dinucleotide (FAD)**, which is reduced to **FADH_2** .

1. Phosphorylation of glucose by ATP.

2-3 Rearrangement, followed by a second ATP phosphorylation.

4-5. The six-carbon molecule is split into two three-carbon molecules—one G3P, another DAP, that is converted into G3P in another reaction.

6. Oxidation followed by phosphorylation produces two NADH molecules and two molecules of BPG, each with one high-energy phosphate bond.

7. Removal of high energy phosphate by two ADP molecules produces two ATP molecules and leaves two 3PG molecules.

8-9 Removal of water yields two PEP molecules, each with a high-energy phosphate bond.

10. Removal of high-energy phosphate by two ADP molecules produces two ATP molecules and two pyruvate molecules.

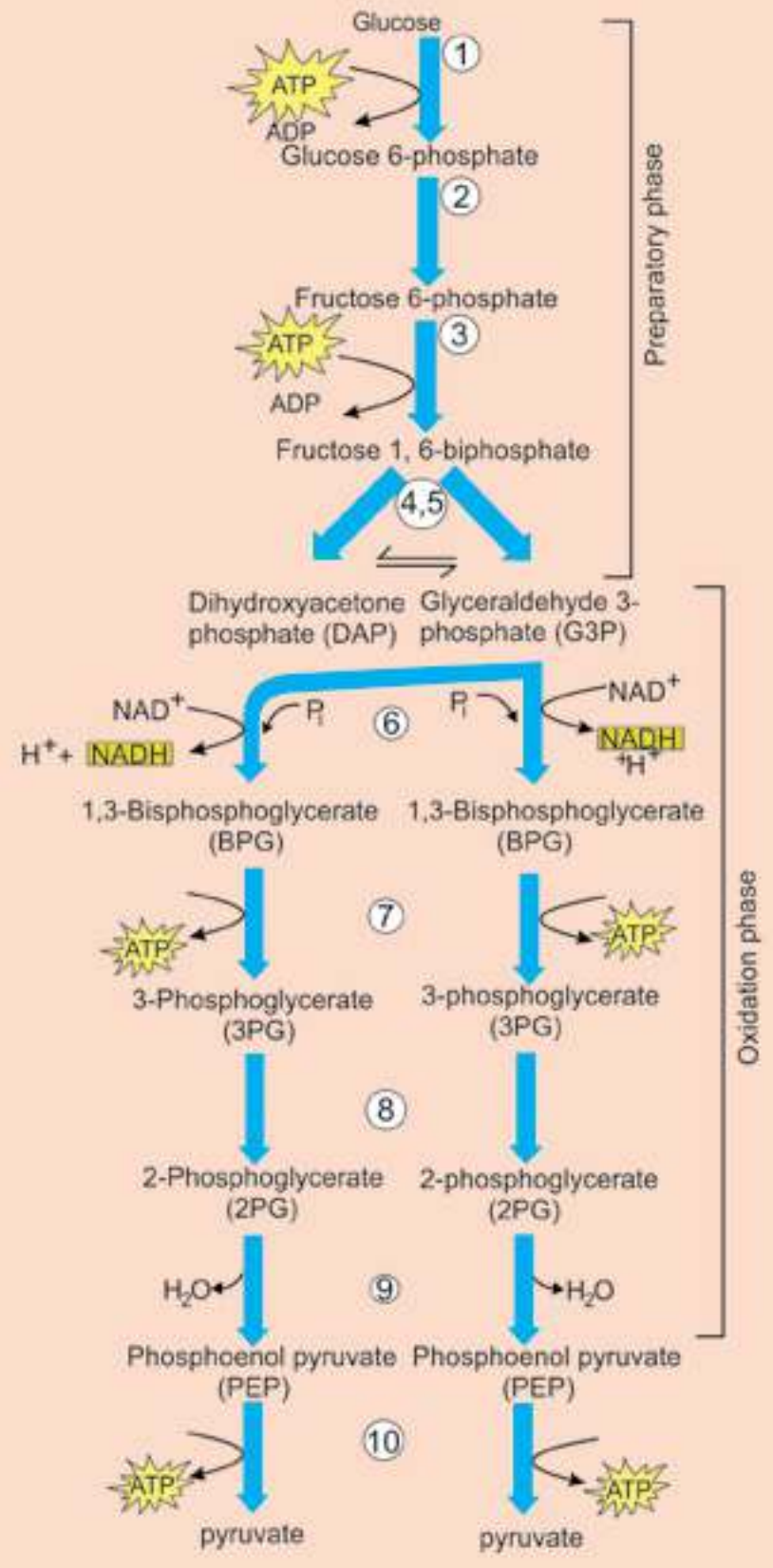

Fig. 11.12 Two phases of glycolysis. All of these reactions take place in the cytosol.

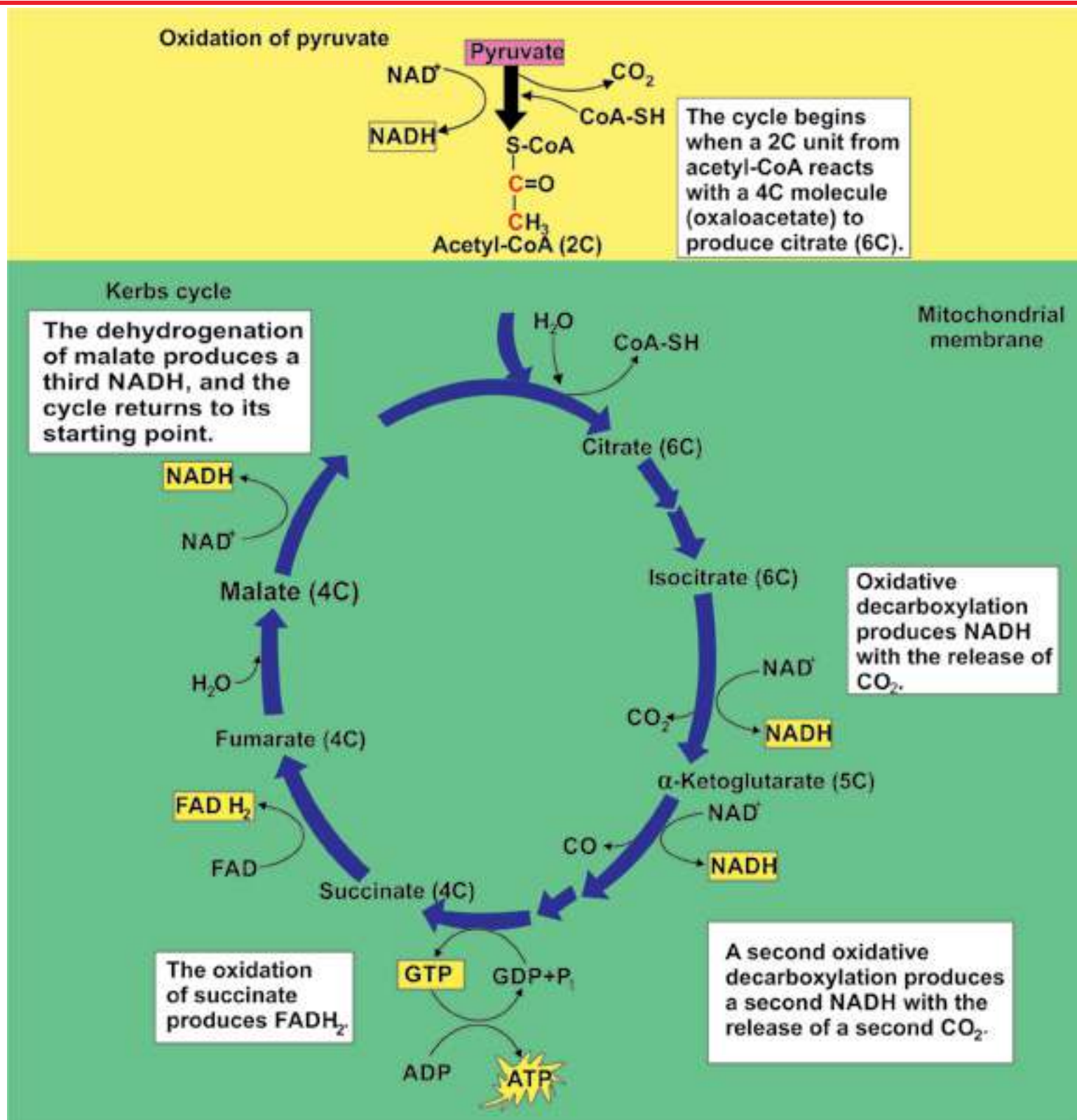

Fig. 11.13 Outline of the Krebs cycle. The brackets give the number of carbon atom in each intermediate of the cycle.

With the addition of another molecule of water, fumarate is converted to **malate**. Another NAD mediated oxidation of malate produces **oxaloacetate**, the original 4-carbon molecule. This completes the cycle. The oxaloacetate may now combine with another molecule of acetyl CoA to enter the cycle and the whole process is repeated (Fig. 11.13).

iv. Respiratory chain: In the Krebs cycle NADH and H^+ are produced from NAD^+ . NADH then transfers the hydrogen atom to the respiratory chain (also called **electron transport system**) where electrons are transported in a series of oxidation-reduction steps to react, ultimately, with molecular oxygen. (Fig. 11.14).

The oxidation reduction substances which take part in respiratory chain are:

- i. A coenzyme called coenzyme Q
- ii. A series of cytochrome enzymes (b,c,a, a_3)
- iii. Molecular oxygen (O_2)

Cytochromes are electron transport intermediates containing **haem** of related prosthetic groups, that undergo valency changes of iron atom. Haem is the same iron containing group that is oxygen carrying pigment in haemoglobin. The path of electrons in the respiratory chain appears to be as follows.

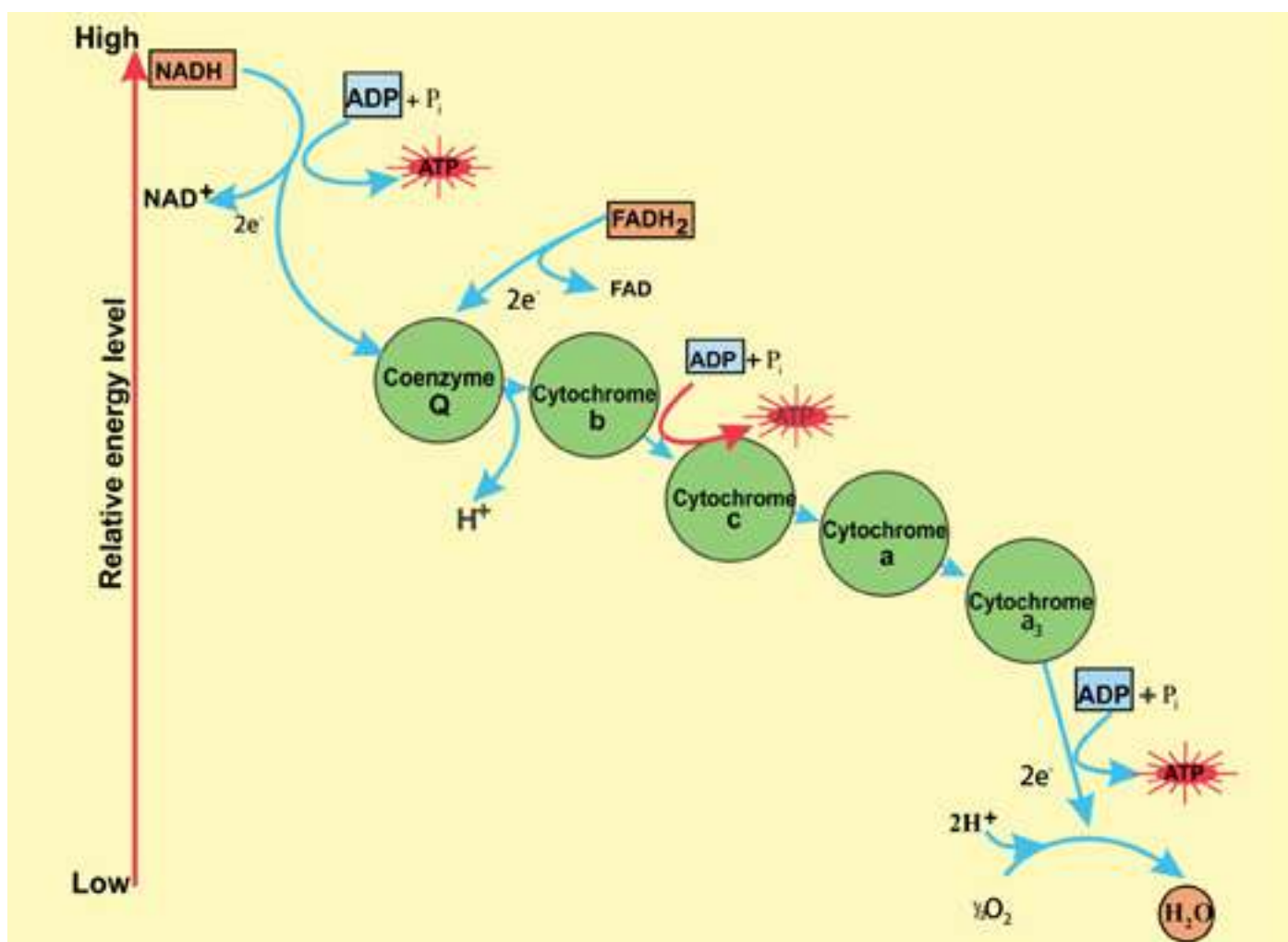

Fig. 11.14 The respiratory electron transport chain and its coupling with oxidative phosphorylation.

NADH is oxidized by **coenzyme Q**. This oxidation yields enough free energy to permit the synthesis of a molecule of ATP from ADP and inorganic phosphate. Coenzyme Q is in turn oxidized by cytochrome b which is then oxidized by cytochrome c. This step also yields enough energy to permit the synthesis of a molecule of ATP. Cytochrome c then reduces a complex of two enzymes called cytochrome a and as (for convenience the complex is referred as cytochrome a). Cytochrome a is oxidized by an atom of oxygen and the electrons arrive at the bottom end of the respiratory chain. Oxygen is the most electronegative substance and the final acceptor of the electrons. A molecule of water is produced. In addition, this final oxidation provides enough energy for the synthesis of a third molecule of ATP.

Oxidative phosphorylation: Synthesis of ATP in the presence of oxygen is called oxidative phosphorylation. Normally, oxidative phosphorylation is coupled with the respiratory chain. As already described ATP is formed in three steps of the respiratory chain (Fig. 11.14). The equation for this process can be expressed as follows:



Where Pi is inorganic phosphate.

The molecular mechanism of oxidative phosphorylation takes place in conjunction with the respiratory chain in the inner membrane of the mitochondrion. Here also, as in photosynthesis, the mechanism involved is chemiosmosis by which electron transport chain is coupled with synthesis of ATP. In this case, however the pumping/movement of protons (H^+) is across the inner membrane of mitochondrion folded into cristae, between matrix of mitochondrion and mitochondrion's intermembrane space. The coupling factors in respiration are also different from those in photosynthesis.

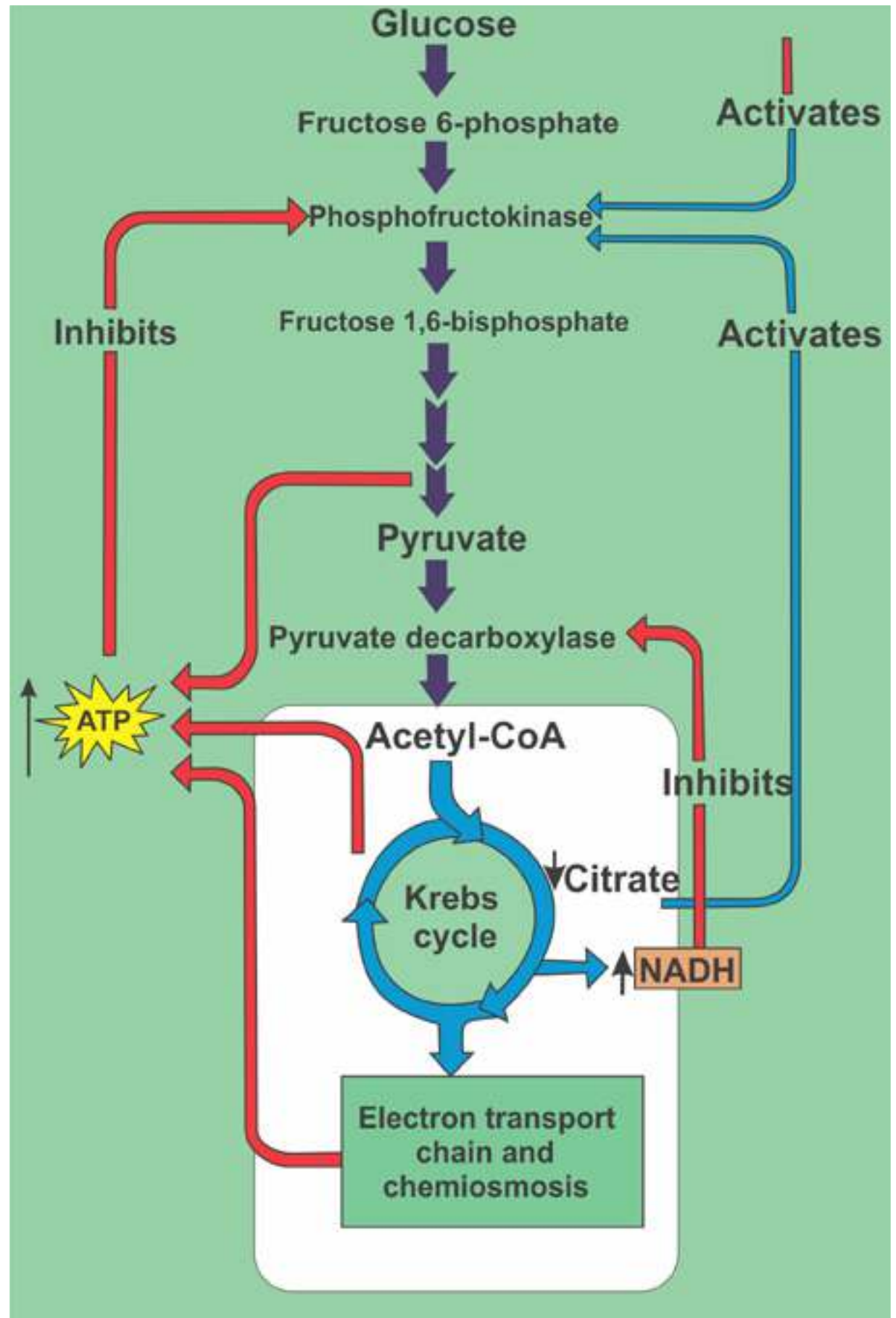

Fig. 11.15 Stages in aerobic respiration. Stage 1: Formation of acetyl-CoA from pyruvate. Stage 2: The Krebs cycle. Stage 3: Respiratory chain and oxidative phosphorylation. Each pair of H atoms entering the respiratory chain as NADH yields 3 ATPs.

EXERCISE

Q1. Write whether the statement is 'true' or 'false' and write the correct statement if it is false.

- (i) Hydroponics are the plants grown in water culture.
- (ii) Calcium is an essential element for chlorophyll formation.
- (iii) Chlorosis means yellowing of leaves due to deficiency of certain essential element of plant nutrition.

Q.2. Short questions.

- (i) List four features of a leaf which show that it is able to carry out photosynthesis effectively.
- (ii) Summarise the role of water in photosynthesis.
- (iii) What are T.W. Engelman and Melvin Calvin famous for?
- (iv) What is the difference between an action spectrum and an absorption spectrum?
- (v) What is the role of accessory pigments in light absorption?
- (vi) When and why is there not net exchange of CO_2 and O_2 between the leaves and the atmosphere?
- (vii) What is the net production of ATP during glycolysis?
- (viii) What is the main difference between photophosphorylation and oxidative phosphorylation?
- (ix) What is the location of ETC and chemiosmosis in photosynthesis and cellular respiration?
- (X) How did the evolution of photosynthesis affect the metabolic pathway?

- (xi) How does absorption spectrum of chlorophyll a differ from that of chlorophyll b?
- (xii) Why are the carotenoids usually not obvious in the leaves? They can be seen in the leaves before leaf fall. Why?
- (xiii) How is the formation of vitamin A linked with eating of carrot?

Q.3. Extensive questions

- (i) Explain the roles of the following in aerobic respiration: (a) NAD⁺ and FAD (b) oxygen.
- (ii) Sum up how much energy (as ATP) is made available to the cell from a single glucose molecule by the operation of glycolysis, the formation of acetyl CoA, the citric acid cycle, and the electron transport chain.
- (iii) Trace the fate of hydrogen atoms removed from glucose during glycolysis when oxygen is present in muscle cells; compare this to the fate of hydrogen atoms removed from glucose when the amount of the available oxygen is insufficient to support aerobic respiration.
- (iv) Sketch Kreb's cycle and discuss its energy yielding steps.
- (v) Describe various steps involved in oxidative break down of glucose to pyruvate.
- (vi) Sketch respiratory electron transport chain. Discuss the significance of ETC.
- (vii) Compare photosynthesis with respiration in plants.
- (viii) Explain the difference between the cyclic and non-cyclic photophosphorylation with the help of Z scheme.
- (ix) Give an account of light-independent reactions of photosynthesis.

CHAPTER

12

NUTRITION

Animation.12.1: Nutrition
Source & Credit: wordpress

All organisms need nutrients for the maintenance of their lives. **Nutrient** is the food or any substance that supplies the body with elements, necessary for metabolism. Certain nutrients (carbohydrates, fats and proteins) provide energy other nutrients (water, electrolytes, minerals and vitamins) are essential to the metabolic process. The sum total of all the processes involved in the taking in and utilization of elements by which growth, repair and maintenance of activities in the organism are accomplished maintenance of activities in the organism are accomplished is called **nutrition**.

Organisms can be divided into two classes on the basis of their methods of nutrition-**autotrophic** and **heterotrophic**. Autotrophic organisms can exist in an exclusively inorganic environment because they can manufacture their own organic compounds from the inorganic raw material taken from the surrounding media. This means that they produce their own sugars, lipids, proteins etc. from carbon dioxide, water and nitrates. Heterotrophic organisms are incapable of manufacturing organic compounds from simple inorganic nutrients and so they obtain organic molecules from the environment in the form of food.

AUTOTROPHIC NUTRITION

See chapter 6 and chapter 11

Mineral nutrition in plants

Generally, all autotrophic or photosynthetic organisms need carbon dioxide and water, which supply the carbon, oxygen and hydrogen. These are the predominant elements, the plant needs for the synthesis of organic molecules. There are many other elements that enter into the composition of plants. **Nitrogen** for example, is present in proteins, **phosphorus** is present in ATP, nucleic acids and many other important compounds; chlorophyll contains **magnesium** and cytochromes contain **iron**. Where does the green plant obtain these elements it needs? Obviously not from carbon dioxide and water, but the soil is the main source of these nutrients. These are essential for the growth and life of the plant. Crops fail to flourish, if grown repeatedly in the same field unless soil is replenished with these nutrients. The farmers replace these by spreading animal manure, sewage sludge or artificial fertilizers in measured quantities over the field. Some chemical fertilizers that are commonly used in Pakistan are urea, super phosphates, ammonium nitrate etc.

Mineral Element Deficiencies

It is very difficult or not possible to ascertain the effects of individual minerals in both plants and animals. However, the deficiencies of some elements cause serious diseases showing clear symptoms. For example nitrogen deficiency in soil results in the stunted growth and strong **chlorosis** (lack of chlorophyll) particularly in older leaves. Deficiency of phosphorus causes stunted growth of roots. Soil deficient in potassium causes leaf margins yellow and brown in colour and premature death of the plant. Deficiency of magnesium results in chlorosis. Many economically important plant diseases due to mineral deficiency are now catalogued with the help of colour photography, enabling rapid diagnosis.

HETEROTROPHIC NUTRITION

METHODS OF PLANT NUTRITION

The plants generally obtain their food from the air or the water in which they grow. There are, however, some special methods of nutrition, which are described below.

Saprophytic Nutrition

Feeding on dead and decaying matter such as dead leaves in the soil or rotting tree trunks is called saprophytic nutrition and derives its nutrients from host plants. They produce extracellular enzymes, which digest the decaying matter and then absorb the soluble products back into their cells. Some bacteria break down the proteins of dead plants and animals and release nitrates which are taken up by the plant roots and then built into new amino acids and proteins, thus helping in nitrogen cycle.

Parasitic Nutrition

Feeding by living in or on other organism (host) belonging to different species is called parasitic nutrition. Parasites attach themselves to living things or their host, for nourishment. For obtaining nourishment from higher plant the parasite penetrates its suckers in the conducting tissue of the host. Puccinia is a parasitic fungus that destroys the wheat plant. Dodder (*Cuscuta*) is a leafless plant that lives as a twining parasite.

Symbiotic Nutrition

It is a mutual nutrition between organisms living in association with one another. These organisms belong to two different species. Some important examples are lichens, mycorrhiza and root nodules with nitrogen fixing bacteria. The **lichen** is made up of a fungus and alga cells. The alga makes food by photosynthesis, while the fungus supplies water and minerals and also protection against desiccation (Fig. 12.1). **Mycorrhiza** is an association between a fungus and roots of higher plants. The fungus depends upon the photosynthate of the plant. The benefit derived by mycorrhiza plant is not properly understood. However, it is known that the plants with mycorrhiza association show better growth than those without fungal partner. **Leguminous plants** have nodules on their roots, which contain nitrogen fixing bacteria (Fig. 12.2). The bacteria live on the plant material and fix nitrogen, converting it into nitrates, which the plant uses.

Possibly the Mycorrhizal fungus benefits the plant by decomposing organic material in the soil and providing water and minerals such as phosphorous to plant.

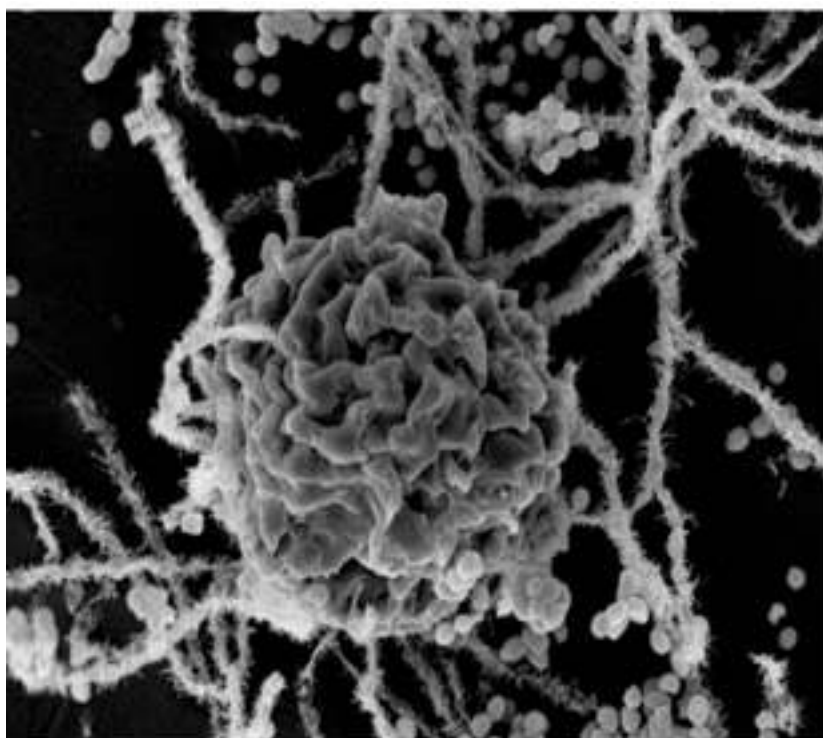

Fig. 12.1. Lichens.

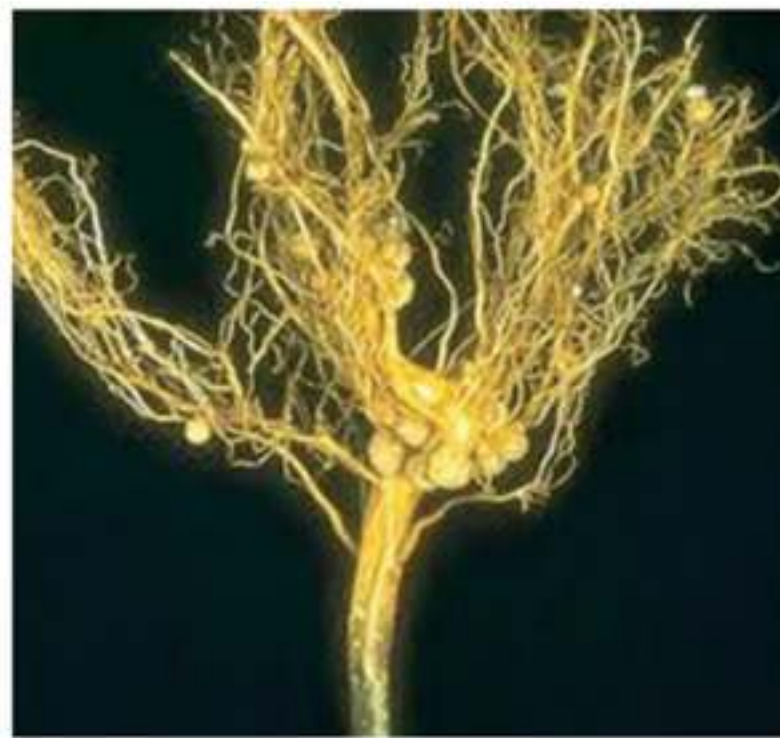

Fig. 12.2. Nodules on leguminous plant roots.

Nutrition in insectivorous plants. There are a few plants that supplement their inorganic diet with organic compounds. These organic compounds are obtained by trapping and digesting insects and small animals. All of the insectivorous plants are true autotrophs, but when they capture prey, their growth becomes rapid. Apparently, nitrogenous compounds of animal body are of benefit to these plants. In some plants, the trapped insects are decomposed by bacteria. In others the trapped insects are digested by enzymes secreted by the leaves. The plants absorb the nitrogenous compounds thus formed.

Pitcher plant (*Sarracenia purpurea*) has leaves modified into a sac or a pitcher, partly filled with water (Fig. 12.3). The end of the leaf is modified to form a hood, which partly covers the open mouth of the pitcher. Small insects that fall into the pitcher are prevented from climbing out by numerous stiff hairs. The proteins of trapped insects are decomposed by bacteria or enzymes and the products of this decay are absorbed by the inner surface of the pitcher leaf.

Venus-fly trap (*Dionaea muscipula*) The leaf is bilobed with midrib between them. There is a row of long stiff bristles along the margins of each lobe. When an insect touches small sensitive hairs on the surface of the leaf, the lobes quickly come together with their bristles interlocked. The trapped insect is then digested by the enzymes secreted from the glands on the leaf surface and the products are then absorbed (Fig. 12.4).



Fig.12.3 Pitcher plant (*Saracenia purpurea*). several fruit flies are entrapped within the leaf.



(a)



(b)

Fig. 12.4 Leaf of Venus fly trap (*Dionaea muscipula*) (a) Fly is about to trigger the hair.
(b) The two halves of the leaf trapping the fly.

Sundew (*Drosera intermedia*) shows another type of modification of leaf for insectivorous activity (Fig. 12.5). The tiny leaves bear numerous hair like tentacles, each with a gland at its tip. The insects, attracted by the plant's odour are entangled. As in the above mentioned example, in sundew also the proteins of insects are digested by enzymes and the products are absorbed.



Fig. 12.5 Leaf of Sundew (*Drosera intermedia*) A dragonfly is caught in the sticky fluid on the ends on the leaf of the glandular hair.

Methods of Animal Nutrition

In large animals, every cell of the body needs nourishment, yet most cells cannot leave their position in the body and travel to a food source, so the food must be delivered. The digestive system provides the body with water, electrolytes, and other nutrients. To do this, digestive system is specialized to ingest food; propel it through the digestive tract; digest the food; and absorb water; electrolytes and other nutrients from the lumen of the digestive tract. Undigested matter from the food is moved out of the digestive tract.

Animals exhibit more variety of nutrition as compared to the plants. On the basis of nutrition animals may be classified as:

Detritivores: The animals which feed on detritus (organic debris from decomposing plants and animals) are called detritivores. Earthworm is the common example of detritus feeder. It ingests fragments of decaying organic matter especially vegetation either at the soil surface or during burrowing activity.

Herbivores: Animals that feed on plants are called herbivores. Typical herbivores include insects, reptiles, birds and mammals. Two important groups of herbivorous mammals are rodents and ungulates. The later are hoofed grazing animals, such as horses, cattle and sheep. In herbivorous mammals the premolars and molars have large grinding surfaces. There is a large gap between the incisors and premolars. Canines are missing. In grazing and browsing herbivores, i.e. deer and sheep, there are no upper incisors.

Carnivores: Animals which feed on other animals are called carnivores. They have large canine teeth for catching and tearing the prey. Incisors, premolars and molars are all adapted for cutting flesh, cracking bones and reducing the chunks to sizes suitable for swallowing. Cats, dogs, lions and tigers are common examples of carnivores. A predator is an animal, which captures and readily kills live animal for its food. The animal, which is eaten, is the prey.

The predator-prey interaction helps in maintaining ecosystem stable. A species in the area without its natural predator leads to disastrous results. The introduction of rabbits into Australia without the predator multiplied to enormous number and proved a menace to the farmers.

Omnivores: These are the animals which eat both plant and animal food. Example of omnivores are crows, rats, red fox, bears, pigs and man. They have the teeth structurally and functionally intermediate between the extremes of specialization attained by the teeth of herbivores and carnivores.

Filter feeders: Many aquatic animals filter the water and digest the particles that they extract from it.

A common mussel possesses two large gills covered with cilia. The movement of cilia causes a current of water to enter animal via an inhalent siphon (Fig. 12.6). The water, which enters, contains the food, such as microscopic algae and protozoa. Secretory cells scattered among cilia produce sticky mucus which entangles food particles. The trapped food particles are then swept towards the mouth by the ciliary movement. Certain types of whales are also filter feeder.

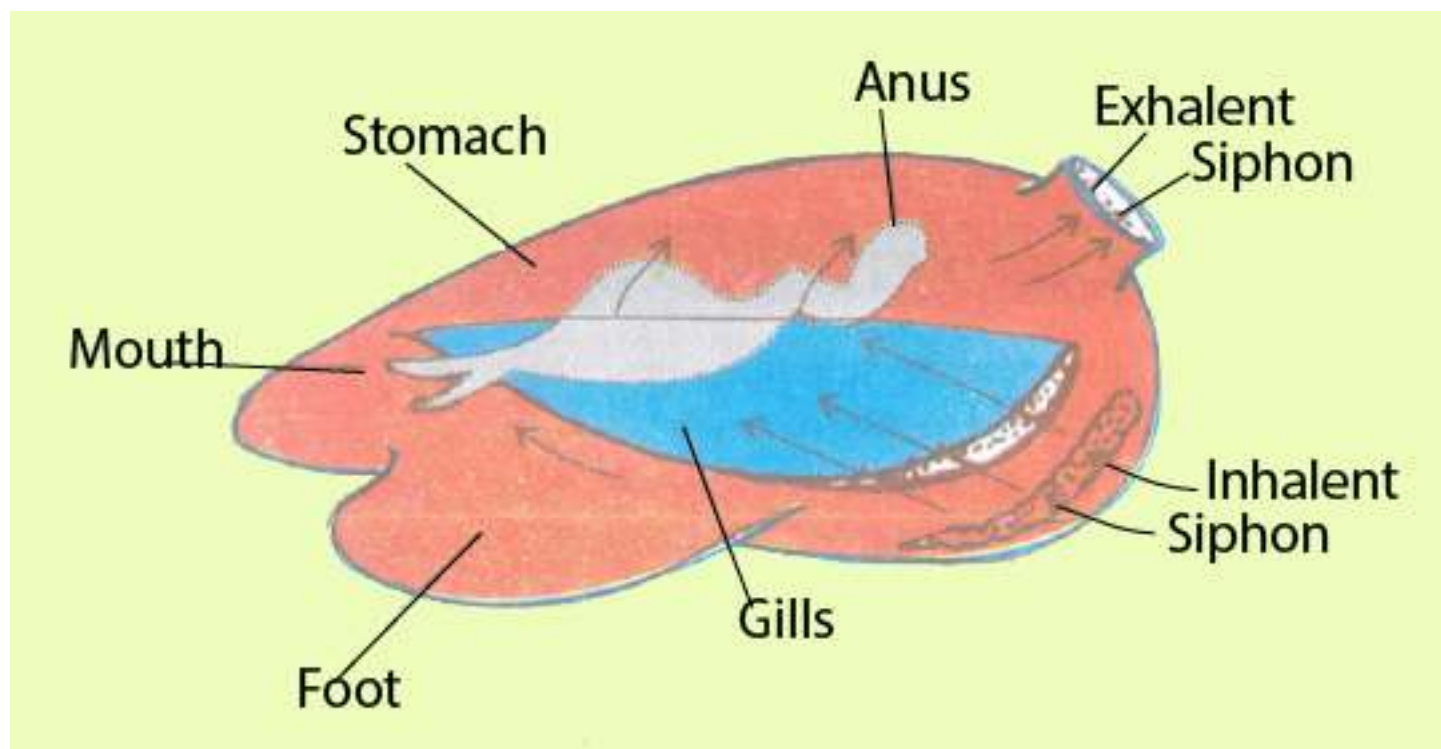

Fig. 12.6 Filter feeding in mussel

Fluid feeders: When the food is ingested in liquid form the animals are classed as fluid feeders. Aphids and mosquitoes are the examples. Aphids suck the phloem juices out of the green stems by inserting their delicate stylets. The female mosquito is also a fluid feeder because it sucks blood from the skin capillaries by piercing the skin with the help of tubular mouth parts.

Macrophagous feeders: Animals, which take in food in the form of large pieces, are macrophagous feeders. Tentacular feeding, scraping and seizing prey are the common methods of macrophagous feeding. Feeding in Hydra is the example of tentacular feeding.

Scraping type of feeding occurs in the garden snail (*Helix*). It feeds by using rasping organ, the radula. Leaves are held by the lips of the snail. The radula moves back and forth over the leaves

with its teeth scraping the food. In this way tiny fragments of leaves are obtained which are gradually pushed backward towards the pharynx. Seizing and swallowing type of macrophagous feeding is found in spotted dogfish.

Parasitic Nutrition

A **parasite** is an organism that lives upon or within another organism, called the host, for obtaining its food. A parasite that lives upon the host is an ectoparasite and that which lives within the host is an **endoparasite**. If an organism lives parasitically at all times, it is said to be an **obligate parasite**. **Facultative parasites** are capable of living independently of its host at times.

Flea and lice are ectoparasites that live in the fur or feathers of mammals and birds and suck blood from their skin. Ticks and mites are common ectoparasites in non-human mammals. In plants, aphid is a parasite that sucks food from leaves or stems.

Leech is another common example of ectoparasite attacking both aquatic and terrestrial animals.

Endoparasites also occur in both aquatic and terrestrial animals. These parasites are most commonly found in the intestine of vertebrate host, including man, where they absorb host's digested food. *Entamoeba histolytica*, tape worm and round worms are common examples of endoparasites. In certain cases the host may be weakened by the presence of parasite or its metabolism may be upset by the excretory products of parasite.

DIGESTION AND ABSORPTION

All animals have similar requirements, although these requirements differ in detail. Animals must have the supply of water, oxygen, simple sugars, amino acids, fatty acids, vitamins and many other inorganic and organic substances. These substances, except oxygen and water, are rare in the natural environment and are not directly available to the organisms. In nature these substances are available in the form of proteins, starches, fats, vitamins and minerals. As such, these molecules except vitamins and minerals are of no use unless they are broken down or digested into simple molecules such as amino acids, sugars and fatty acids so that they may pass through the cell membrane and be used by the body. The characteristic processes involved in holozoic nutrition are defined as

(a) **Ingestion** taking in of complex food.

(b) **Digestion**- the breakdown of complex organic compounds of food into simpler diffusible molecules by the action of enzymes e.g. proteins (meat, fish, eggs etc.) into amino acids. Digestion may be either **Intracellular or extracellular**. In intracellular, break down of food occurs within the cells. In extracellular digestion, enzymes are secreted outside the cell into the gut cavity or lumen where then digestion takes place.

(c) **Absorption** is the uptake of the diffusible food molecules from the digestive region across the membrane in to the cell or into the blood stream.

(d) **Assimilation** is the utilization of the products of digestion for production of energy or synthesis of cellular material.

(e) **Egestionis** the elimination of undigested matter from the body.

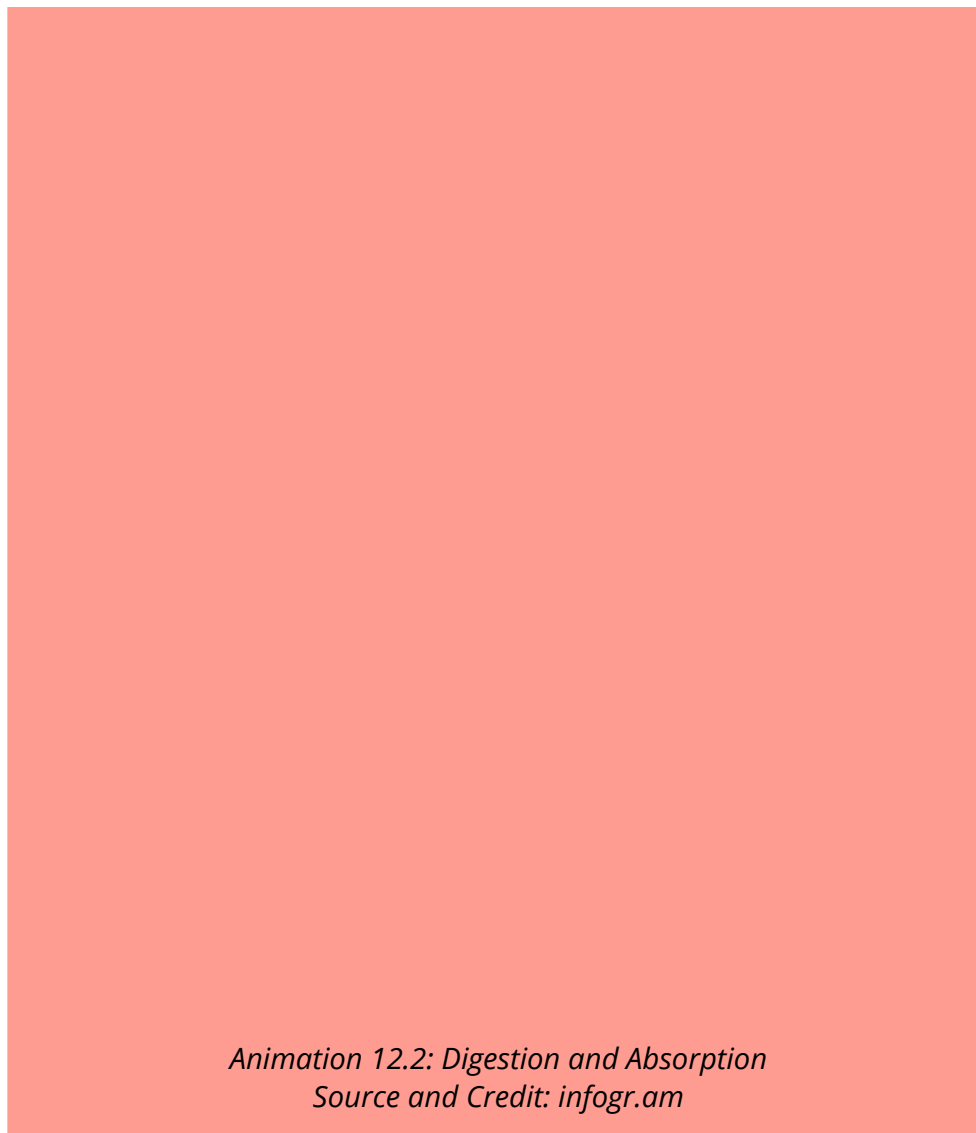

Digestion in Amoeba

Amoeba proteus has intracellular mode of digestion and feeds on many kinds of tiny organisms which live with it in fresh water ponds and shallow lakes. *Amoeba* also feeds on particulate organic matter. Food may be ingested at any points on the surface of the body. When *Amoeba* comes in contact with food particle, it immediately puts out pseudopodia around it. These pseudopodia fuse together around the food particle forming the food vacuole (Fig. 12.7). If the food particle is too big, such as *Paramecium*, *Amoeba* encircles it, thus forming a large food vacuole. The food vacuole undergoes many changes as digestion proceeds. First it grows smaller, then larger and again smaller. Lysosomes, which contain hydrolytic enzymes, fuse with the food vacuole and enzymes are secreted into it. The first phase of digestion is killing and softening of food that take place in the acidic medium (approximately pH 5.6) and later it becomes alkaline (about pH 7.3) during which digestion is completed. When digestion is complete in food vacuole membrane is drawn into numerous fine canals. The products of digestion are passed into the canals and finally into the surrounding cytoplasm and subsequently utilized in various metabolic reactions of the animal. Undigested matter is voided from the organism in the surrounding water by egestion at any point of its surface (Fig. 12.8).

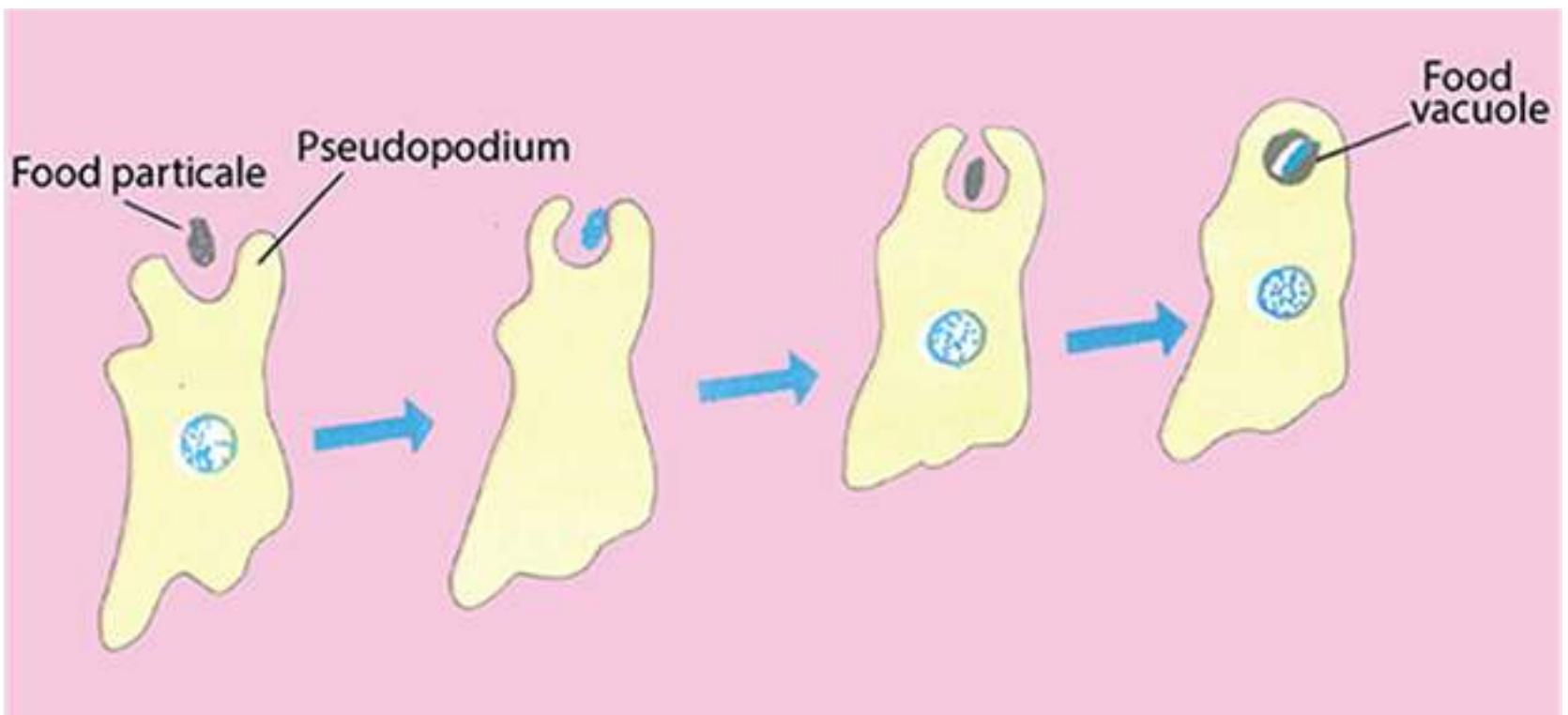

Fig. 12.7 Amoeba ingesting food by pseudopodia

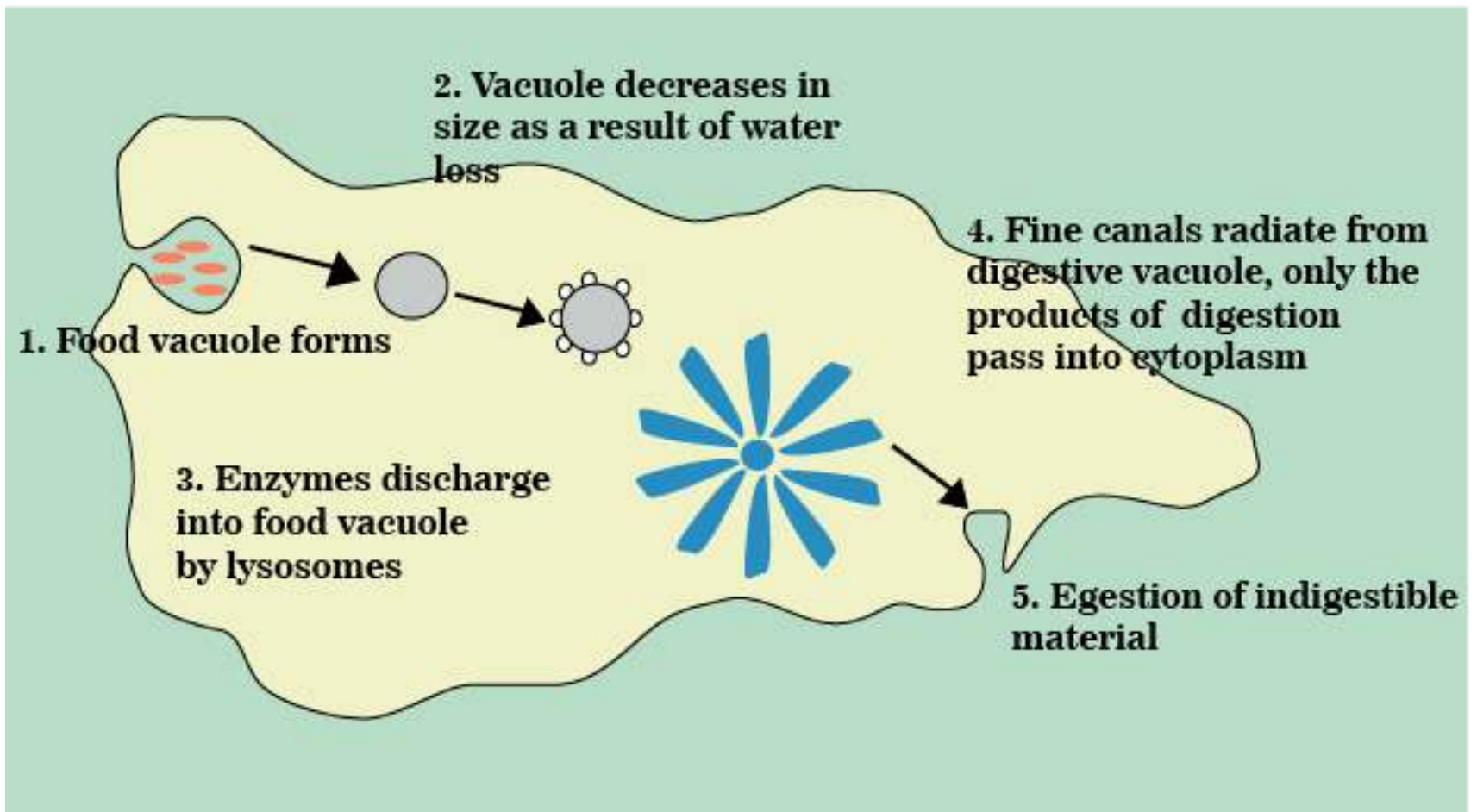
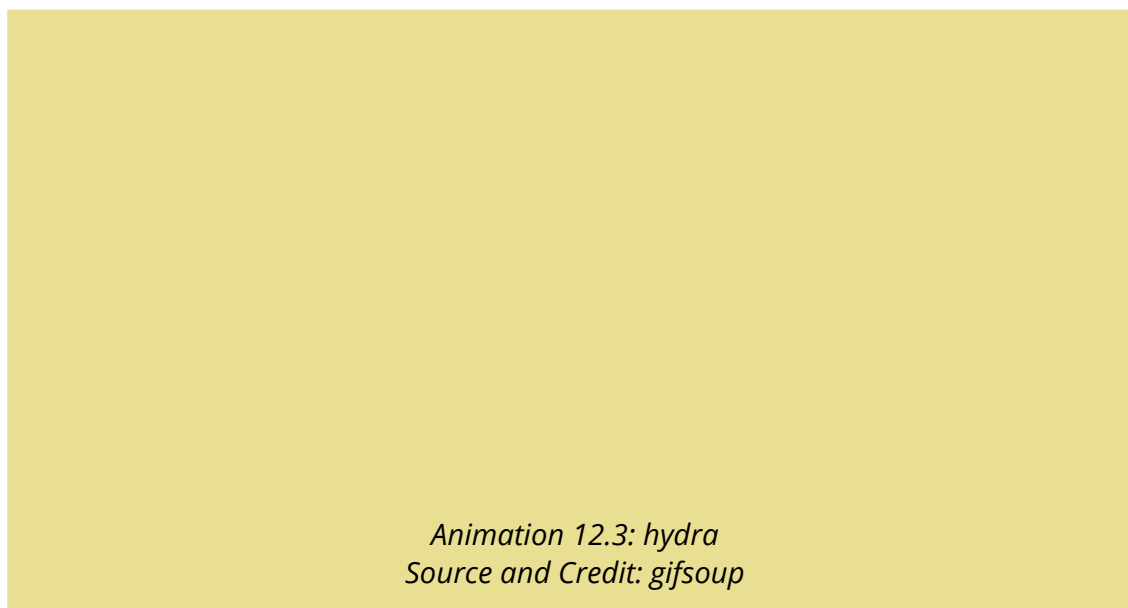

Fig. 12.8. Ingestion, digestion and absorption in Amoeba

Digestion in Hydra

Hydra is an aquatic, diploblastic cnidarian. It has a vase-like body composed of two principal layers of cells. The central cavity of the body functions as a digestive cavity. The animal has only one opening to the outside called mouth which is surrounded by mobile tentacles. The digestive cavity of this sort is called gastrovascular cavity or **coelenteron** (Fig. 12.9a).



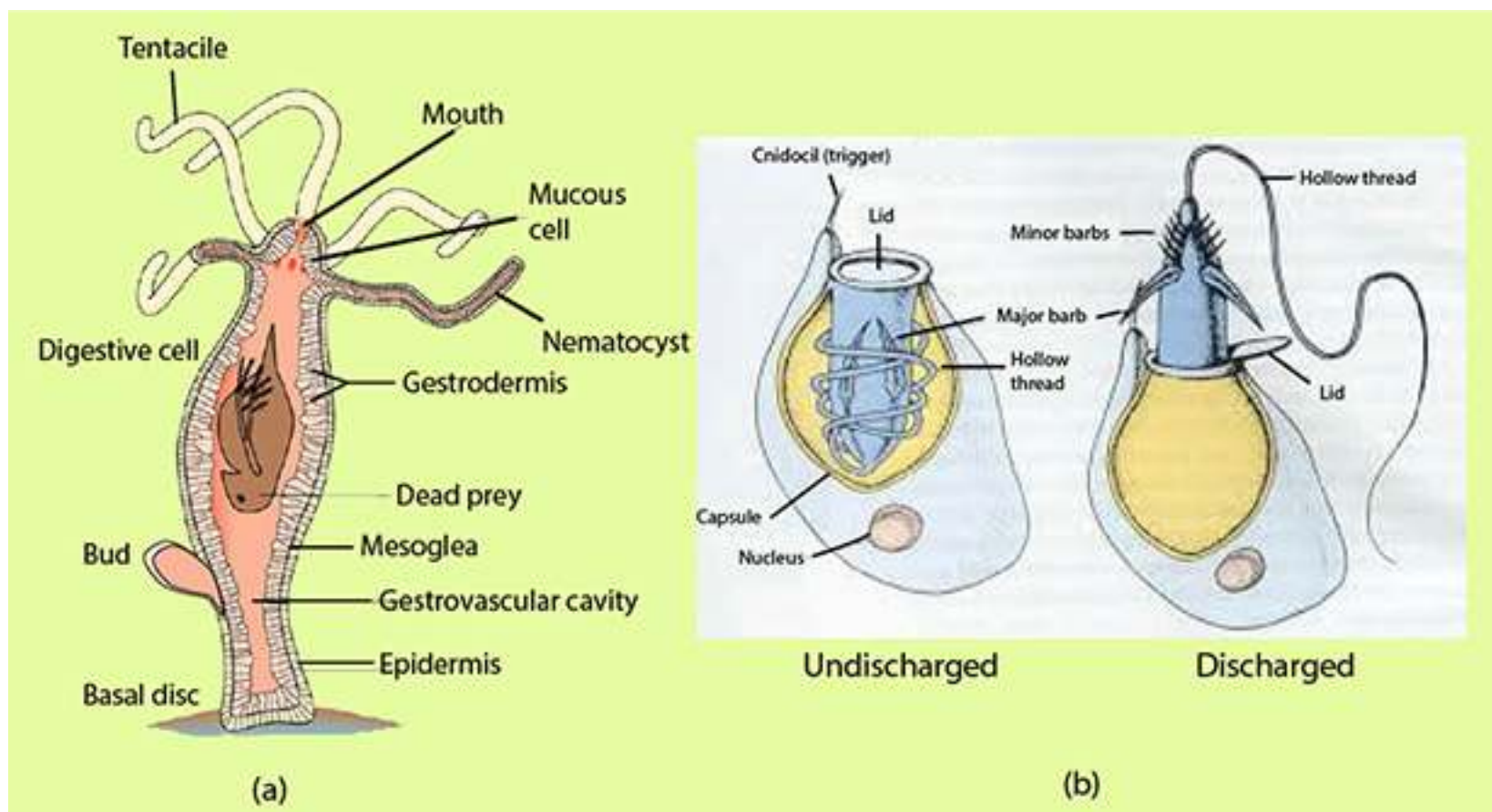
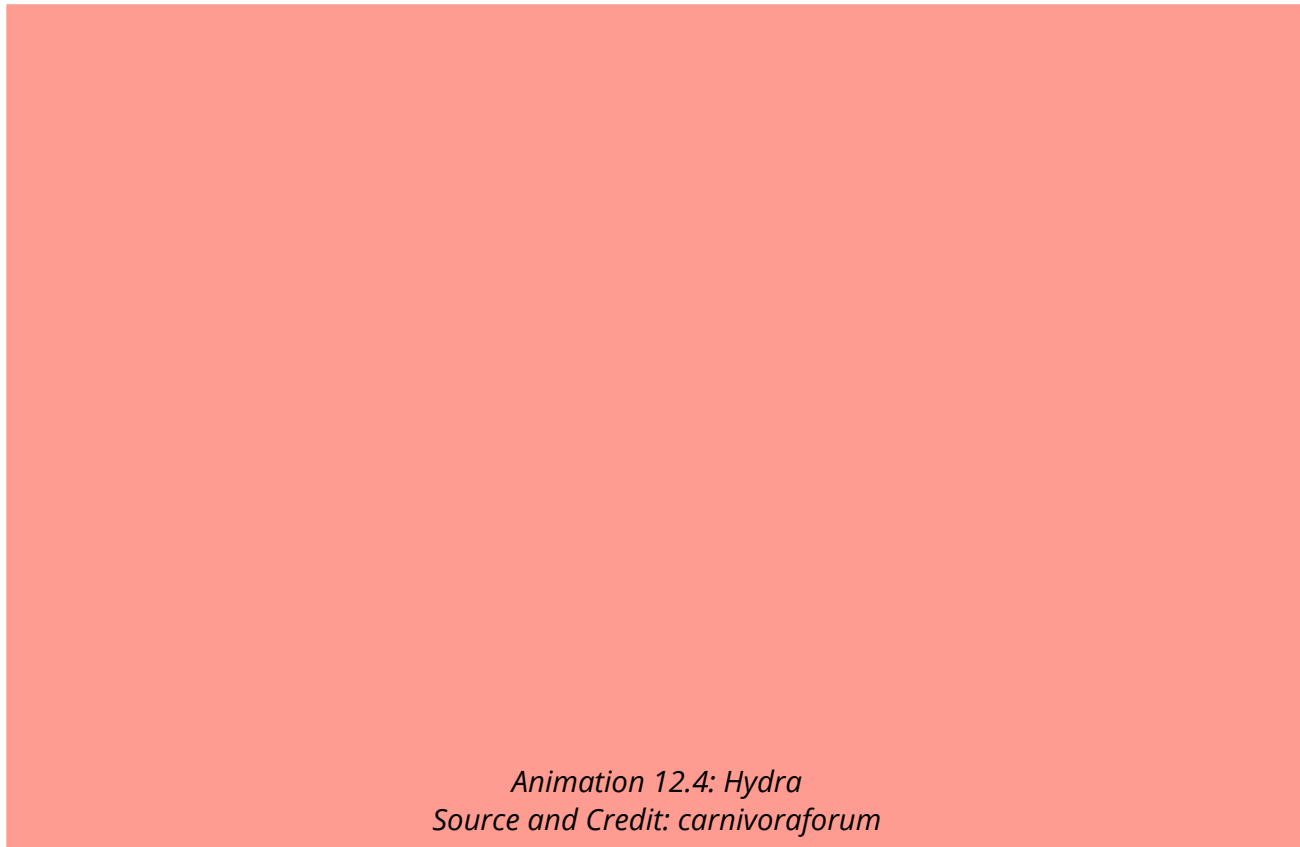

Fig. 12.9. *Hydra*: (a) Longitudinal section showing the detail of wall and the gastrovascular cavity (b) nematocysts (discharged and un-discharged)

Embedded in the tentacles are numerous stinging cells called **nematocysts**. Each nematocyst consists of a hollow thread coiled within a capsule and a tiny hair-like trigger, projecting outside (Fig. 12.9 b).

When a prey such as *Daphnia* or *Cyclops* comes in contact with the cnidocil the hollow thread of the nematocyst turns inside out, ejects poison and the prey is paralysed or some times killed. *Hydra* then grasps its prey with its tentacles and pushes it into the digestive cavity through open mouth.

The glandular cells in the gastrodermis secrete enzymes which start extracellular digestion. Gastrodermal flagellate cells and contraction of body cavity help in mixing food with enzymes and breaking up into fine particles. These fine particles are then engulfed by phagocytic action of gastrodermal cells where digestion is completed intracellularly in the digestive vacuoles. Indigestible food is expelled out from the gastrovascular cavity via mouth. Such a digestive system is called sac-like digestive system having a common opening for ingestion and egestion.



Digestion in Planaria

Planaria is free-living, flatworm found in fresh water streams and ponds. There is a single gut opening, the mouth which is located on the ventral surface near the middle of the animal. The mouth opens into a muscular tubular pharynx, which leads into the intestine. The intestine then immediately divides into three branches - an anterior one, extending forward and two lateral branches. Each of these main branches gives off numerous small branches which end blindly called caecae (Fig. 12.10).

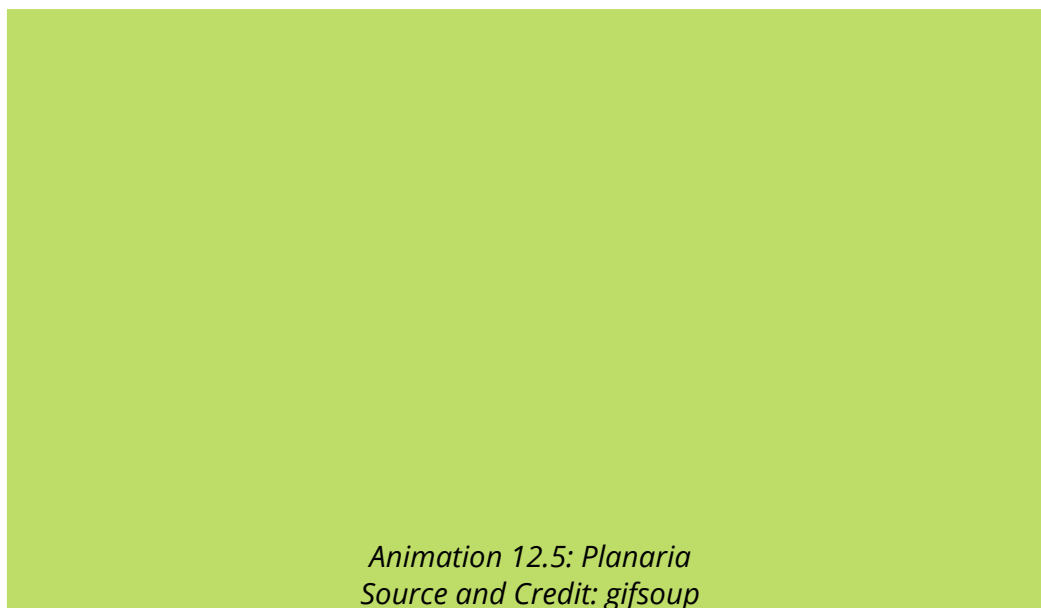

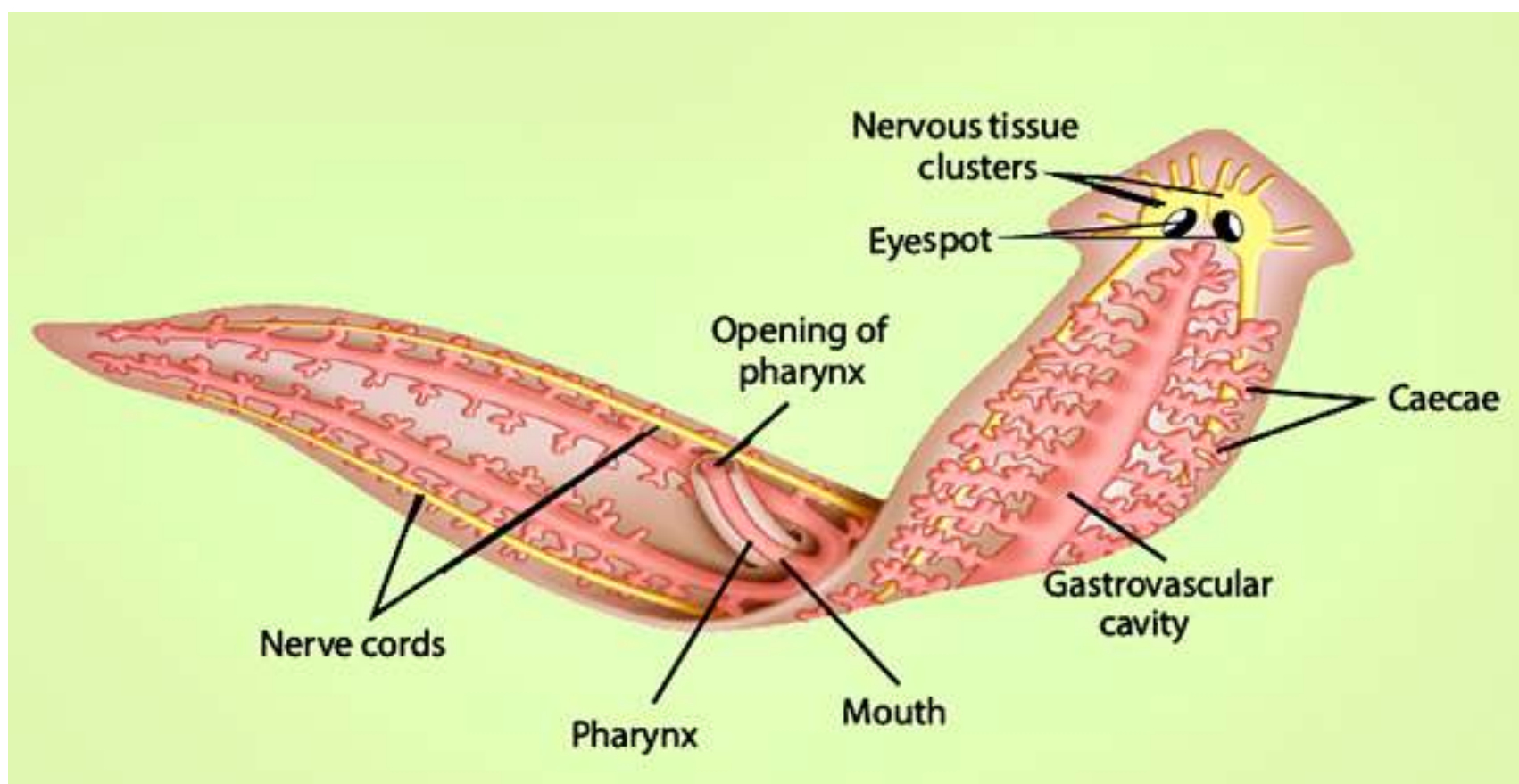

Fig. 12.10. *Planaria* showing much branched gastrovascular cavity and extruded pharynx.

Planaria engulfs the prey by protruding eversible pharynx through the mouth and pushes it into the gastrovascular cavity. Food is then digested in the intestine. Enzymes are secreted by the gland cells of the intestine and continue the process of extracellular digestion. Small particles of food are finally engulfed by phagocytic cells. Digestion is completed intracellularly, from where the products of digestion pass to the rest of the body, by the process of diffusion. Branched intestine also facilitates diffusion of materials into body cells. Undigested food is egested through the mouth.

Digestion in Cockroach

The digestive system of cockroach is of tubular type. It can be divided into fore, mid and hind gut. The foregut includes mouth cavity, pharynx, crop and gizzard. A pair of salivary glands is present in the thorax region of the animal. They secrete saliva, which is poured into the mouth cavity. The midgut is a short narrow tube called **mesenteron stomach**. Short finger like hollow tubes, the **hepatic caecae** open into the anterior end of the midgut.

The hind gut is a long coiled tube, the terminal part of which is a thick walled chamber, the **rectum**, which opens to the exterior through anus (Fig. 12.11).

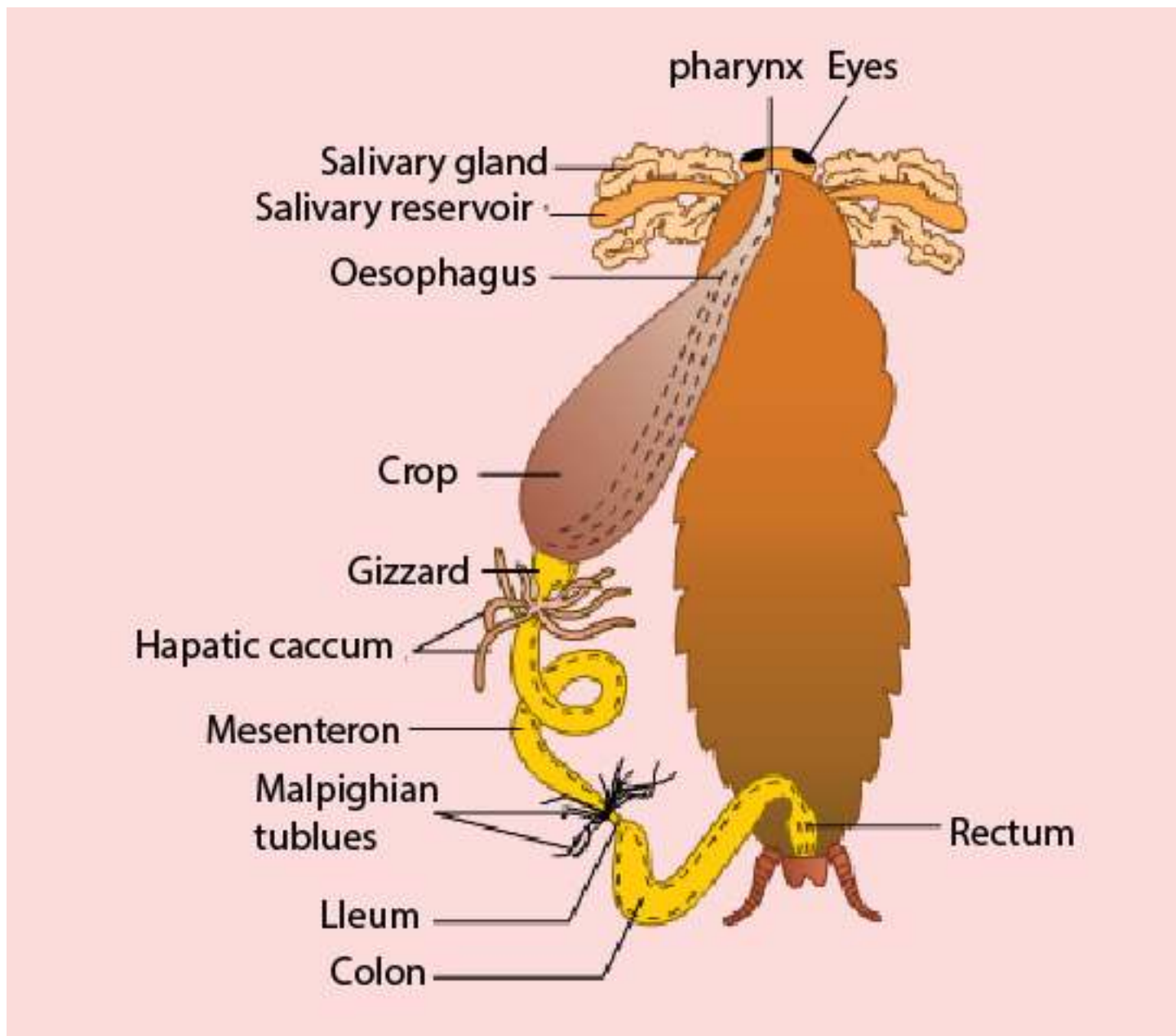

Fig. 12.11. Cockroach digestive system

The cockroach feeds on all types of food. After cutting the food into small pieces with the help of mandibles, it is mixed up with saliva in the mouth cavity. The digestive enzymes of saliva hydrolyse the starchy matter contained in food. The partly digested food is stored in the **crop**. Food leaves the crop chunk by chunk and after being ground in the **gizzard** it moves into the midgut. The enzymatic secretions of hepatic caecae and midgut digest the food completely. The indigestible food after temporary storage in the **rectum**, as fecal matter is then egested out through anus.

Cockroach has a tubular digestive system having mouth for ingestion and anus or cloacal aperture for egestion. It is more efficient system than sac like digestive system having specialized organs or partitions for efficient digestion and absorption of food.



Digestion in Man

The **digestive system** of man consists of a long coiled tube that extends from the mouth to the anus. The main parts in the direction of passage of food, are the **oral or buccal cavity, esophagus, stomach, small intestine (duodenum, jejunum and ileum), large intestine (ascending colon, transverse colon, descending colon, caecum and rectum)**. (Fig. 12.12) Associated with the various regions are the glands, especially **salivary glands, liver and pancreas**. There are three sites of digestion in the digestive system of man - oral cavity, stomach and small intestine.

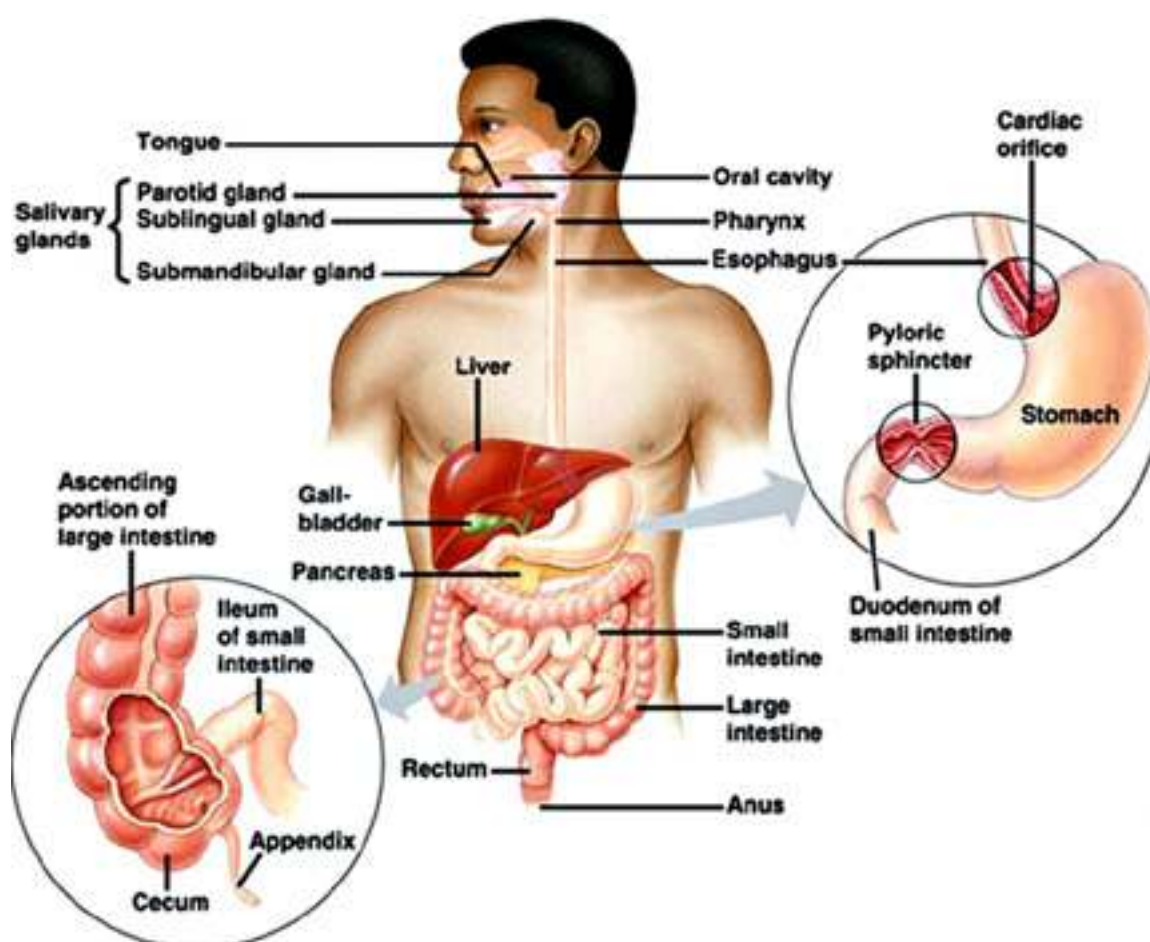

Fig. 12.12 The digestive system of man.

Digestion in Oral Cavity There are several functions of the oral cavity, the most obvious being the (a) selection of food, (b) grinding or mastication (c) lubrication and (d) digestion.

Selection of food: When food enters the oral cavity (the cavity bounded by palate, tongue, teeth and cheeks) it is tasted, smelled and felt. If the taste or smell is unpleasant or if hard objects like

bone or dirt are present in the food, it is rejected. Oral cavity is aided in selection by the senses of smell, taste and sight. Tongue being sensory and muscular organ plays the most important role in selection of food through its taste buds.

Grinding or mastication: After selection, the food is ground by means of molar teeth into smaller pieces. This is useful because : (a) the esophagus allows relatively small pieces to pass through and (b) small pieces have much more surface for the enzyme to attack.

Lubrication and digestion: These are the main functions of the oral cavity accomplished by saliva. Saliva is secreted by three pairs of **salivary glands** namely **sublingual** glands situated below the tongue; **submaxillary** glands behind the jaws and **parotid glands** in front of the ears. Saliva produced by these glands contains three important ingredients.

i) Water and mucus, ii) Sodium bicarbonate and some other salts, iii) Carbohydrate digesting enzymes, **amylase or ptyalin**.

Water and mucus together make a slimy liquid which serves to moisten and lubricate the food so that it can be chewed efficiently and passed through the esophagus smoothly.

Sodium bicarbonate and some other salts are slightly antiseptic but their main function is to stabilize the pH of food. Fresh saliva is alkaline with a pH nearly 8, quickly loses carbon dioxide and gets to pH 6. Ptyalin is a carbohydrate - digesting enzyme, which digests starch and glycogen to maltose.

Swallowing: As a result of mastication, the softened, partly digested, slimy food mass is rolled into small oval lump called **bolus**, which is then pushed to the back of the mouth by the action of tongue and muscles of pharynx which ensure that the food does not enter the windpipe. Following are the events which occur during swallowing:

- i) the tongue moves upwards and backwards against the roof of the mouth, forcing the bolus to the back of the mouth cavity.
- ii) The backward movement of the tongue pushes the soft palate up and closes the nasal opening at the back. At the same time the tongue forces the epiglottis (a flap of cartilage) into more or less horizontal position thus closing the opening of the windpipe (the glottis).

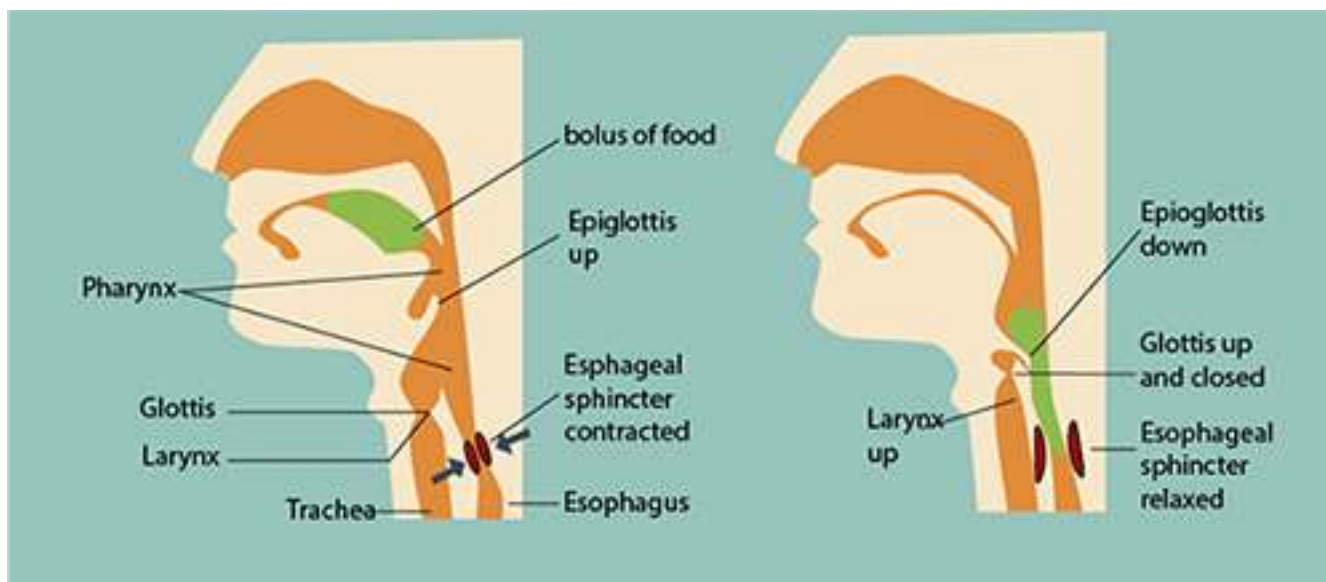

Fig, 12.13 Swallowing in man

- iii) The larynx, cartilage round the top of the windpipe moves upward under the back of the tongue.
- iv) The glottis is partly closed by the contraction of a ring of muscle.
- v) The food does not enter the partly open glottis, because the epiglottis diverts the food mass to one side of the opening and safely down the esophagus. The beginning of the swallowing action is voluntary, but once the food reaches the back of the mouth, swallowing becomes automatic. The food is then forced down the esophagus by peristalsis (Fig. 12.13).

Peristalsis These are characteristic movements of the digestive tract by which food is moved along the cavity of the canal. It consists of the wave of contraction of the circular and **longitudinal** muscles preceded by the wave of relaxation thus squeezing the food down along the canal. Peristalsis starts just behind the mass of food from the buccal cavity along the esophagus to the stomach and then along the whole alimentary canal (Fig. 12.14). Occasionally, the movements are reversed, with the result food may be passed from the intestine back into the stomach and even into the mouth. This movement is called **antiperistalsis**, leading to vomiting. Hunger contractions are peristaltic contractions which are increased by low blood glucose levels and are sufficiently strong to create an uncomfortable sensation often called a “hunger pang”. Hunger pangs usually begin 12 to 24 hours after the previous meal or in less time for some people.

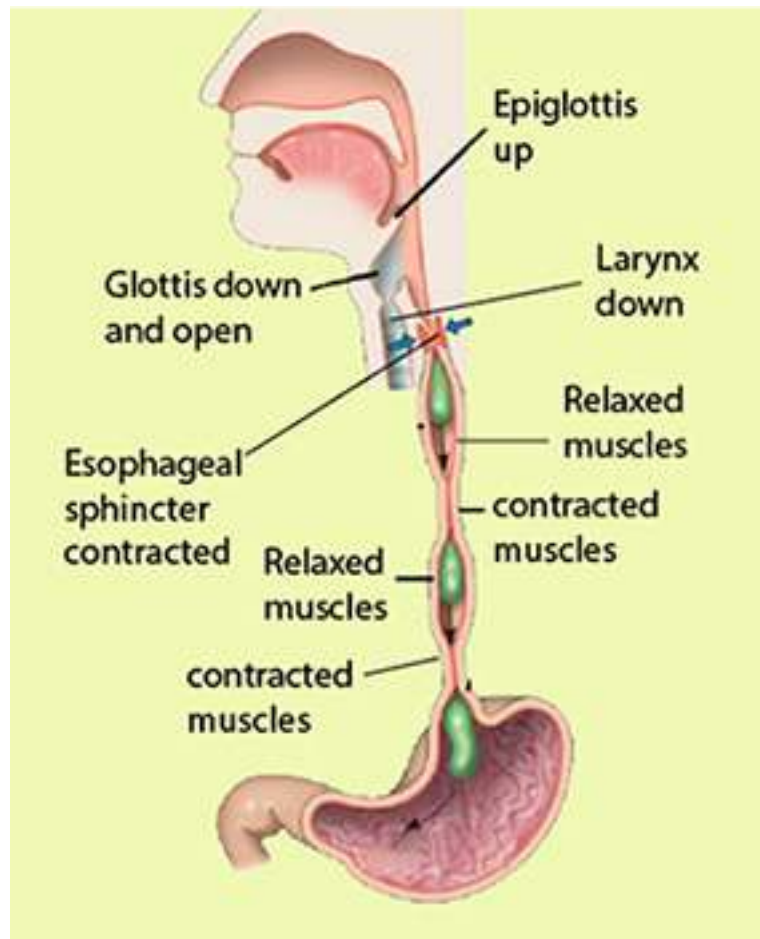

Fig. 12.14 Different stages of peristaltic movement in the esophagus.

Gravity assist the movement of material through the esophagus, especially when liquids are swallowed. However, the peristaltic contractions that move material through the esophagus are sufficiently forceful to allow a person to swallow, even while doing a headstand.

Digestion in stomach

At the junction between esophagus and the stomach there is a special ring of muscles called **cardiac sphincter**. When the sphincter muscles contract, the entrance to the stomach closes and thus prevents the contents of the stomach from moving back into the esophagus (Fig. 12.15a). It opens when a wave of peristalsis coming down the esophagus reaches it.

The stomach is situated below the diaphragm on the left side of the abdominal cavity. It is an elastic muscular bag that stores food from meals for some time, making discontinuous feeding possible. It also partly digests the food.

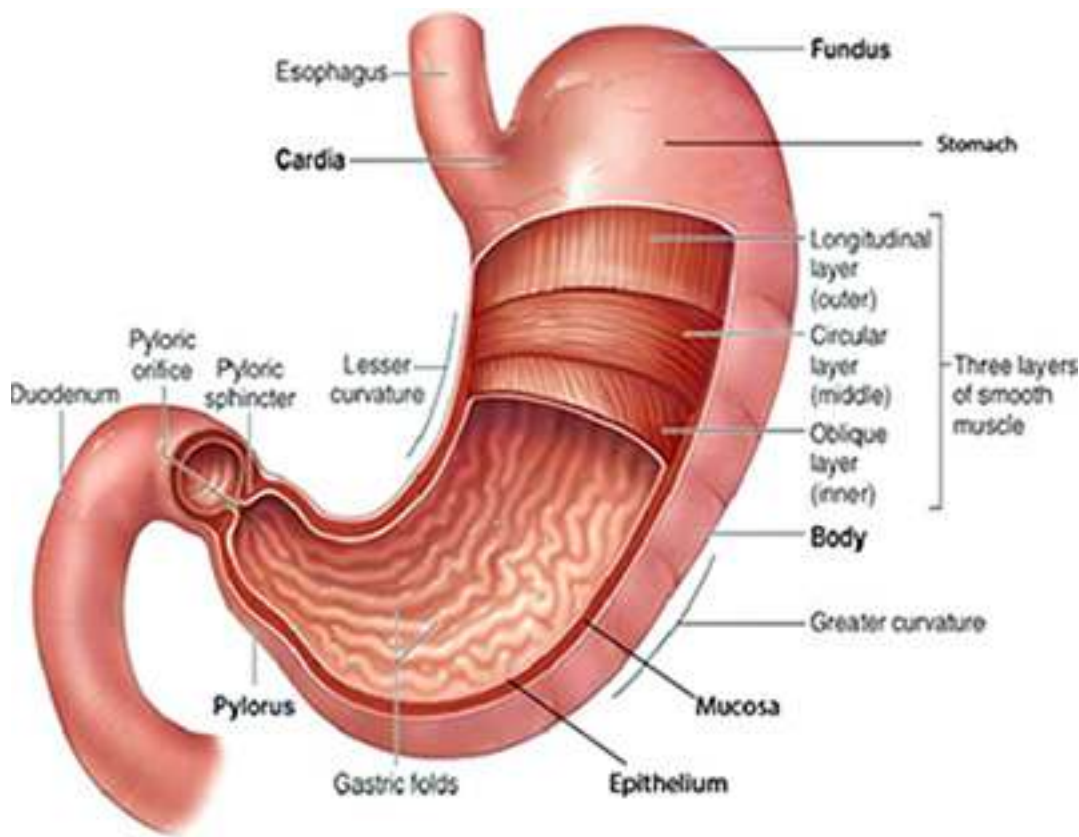

Heart burn, or Pyrosis, is a painful burning sensation in the chest usually associated with the back flush of acidic chyme into the esophagus. This is due to overeating, eating fatty food, lying down immediately after a meal, consuming too much alcohol, caffeine or smoking.

Fig. 12.15 (a) Sagittal section of human stomach showing internal ridges and sphincters.

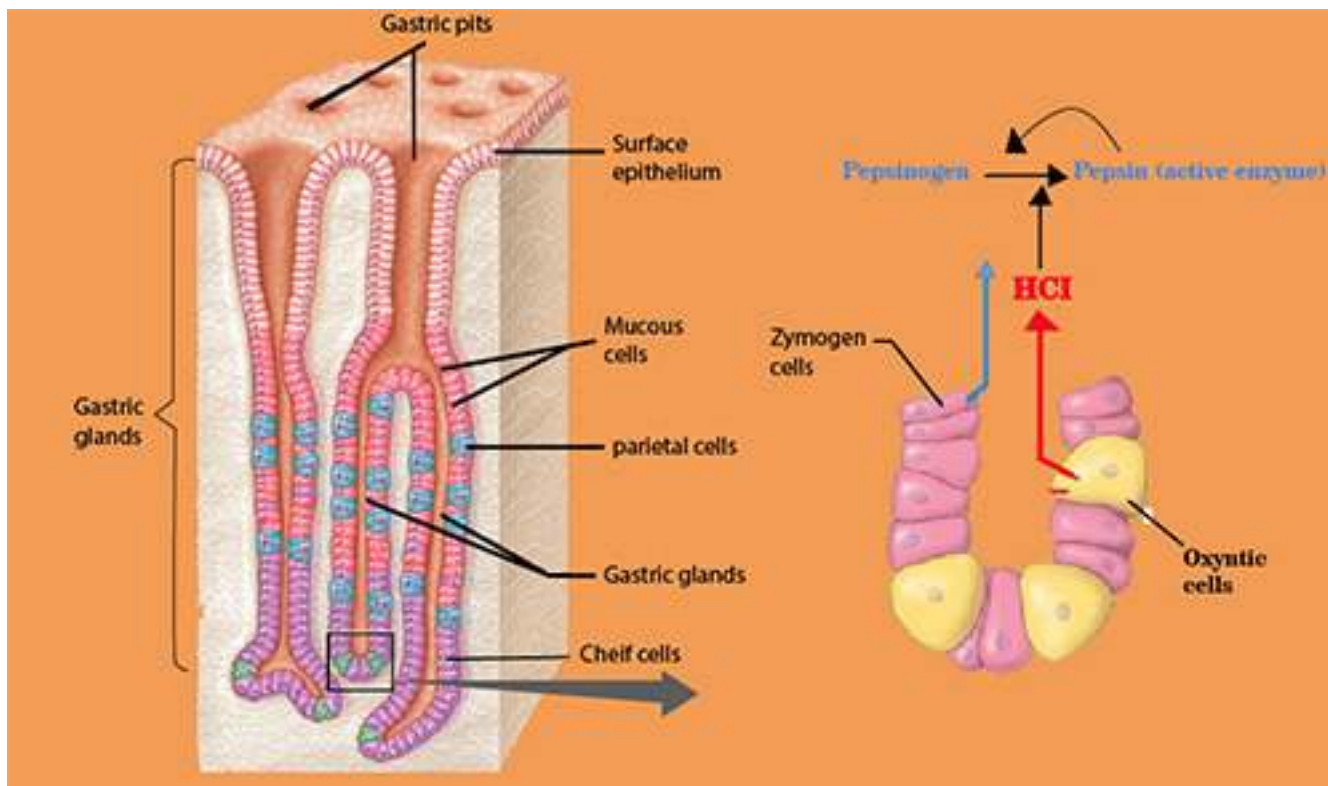

(b) Section through stomach wall

(c) Detail of gastric gland in the stomach wall

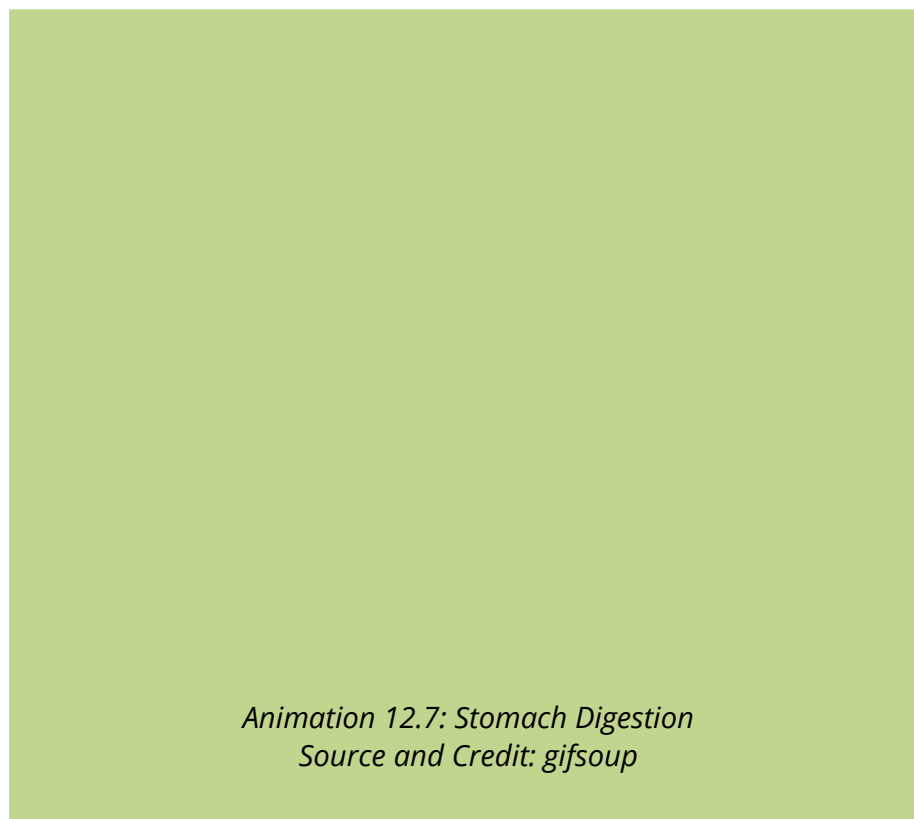

The stomach wall is composed of three principal layers: an outer layer of connective tissue; middle layer of smooth muscles and inner layer (mucosa) of connective tissue with many glands. The middle layer of muscles consists of outer longitudinal and inner circular muscles (Fig. 12.15 b). These muscular layers help in churning and mixing the food with the stomach secretions. The mucosa of the stomach possesses numerous tubular gastric glands, which are composed of three kinds of cells;

a) **mucous cells**, that secrete mucus, b) **parietal or oxyntic cells** secrete hydrochloric acid and c) **zymogen cells**, which secrete **pepsinogen** (Fig. 12.15c). The secretion of all these cells is collectively called **gastric juice**. The secretion of the gastric juice is regulated by smell, sight and quality of food.

If more protein is present in the food it stimulates the production of gastrin hormone from the gastric endocrine lining, which is carried by blood to the gastric glands and stimulates them to produce more gastric juice. Thus more proteins more gastrin and more gastric juice for digestion.

Mucus is a thick secretion that covers the inside of the stomach. It prevents the underlying walls from being digested.

Hydrochloric acid is secreted in concentrated form. It adjusts the pH of stomach contents ranging from 2-3 for the pepsin to act on proteins. It also softens the food and kills many microorganisms taken in along with the food.

Pepsin is an enzyme secreted in an inactive form called pepsinogen. Pepsinogen is activated to pepsin when exposed to the acidic medium or to some already activated pepsin. Pepsin hydrolyzes protein to yield peptones and polypeptides.

The muscles of stomach wall thoroughly mix up the food with gastric juice and eventually convert it to semi-solid mass called **chyme**. Gradually the stomach empties into the duodenum through the relaxed pyloric sphincter.

Digestion in small intestine

Small intestine in man consists of duodenum, jejunum and ileum. Duodenum is about 20-25 cm long, which leads into jejunum and then ileum. When chyme passes from stomach into duodenum, its acidity stimulates the release of secretions from pancreas, liver and duodenal cells.

Hepatic and Pancreatic secretions are also stimulated by a hormone called secretin, which is produced by the intestinal mucosa on the entry of acidic food from stomach. The acidity stimulates secretin production in duodenum and secretin is carried by blood to pancreas which is stimulated to produce pancreatic juice. Secretin also inhibits gastric secretion.

Pancreas is a large gland whose exocrine tissue secretes a juice that flows through pancreatic duct into the duodenum. Included in this juice are enzymes that digest all principal components of food i.e. carbohydrates, fats and proteins. Carbohydrate- digesting enzyme is pancreatic **amylase** also called amylopsin, which digests starch into maltose. Fat digesting enzyme is **lipase**, that hydrolyzes a small percentage of fats into fatty acids and glycerol. Like pepsin, trypsin is also secreted as inactive trypsinogen, which is activated by enterokinase, an enzyme secreted by the lining of the duodenum.

*Animation 12.8: Pancreas
Source and Credit: gifsoup*

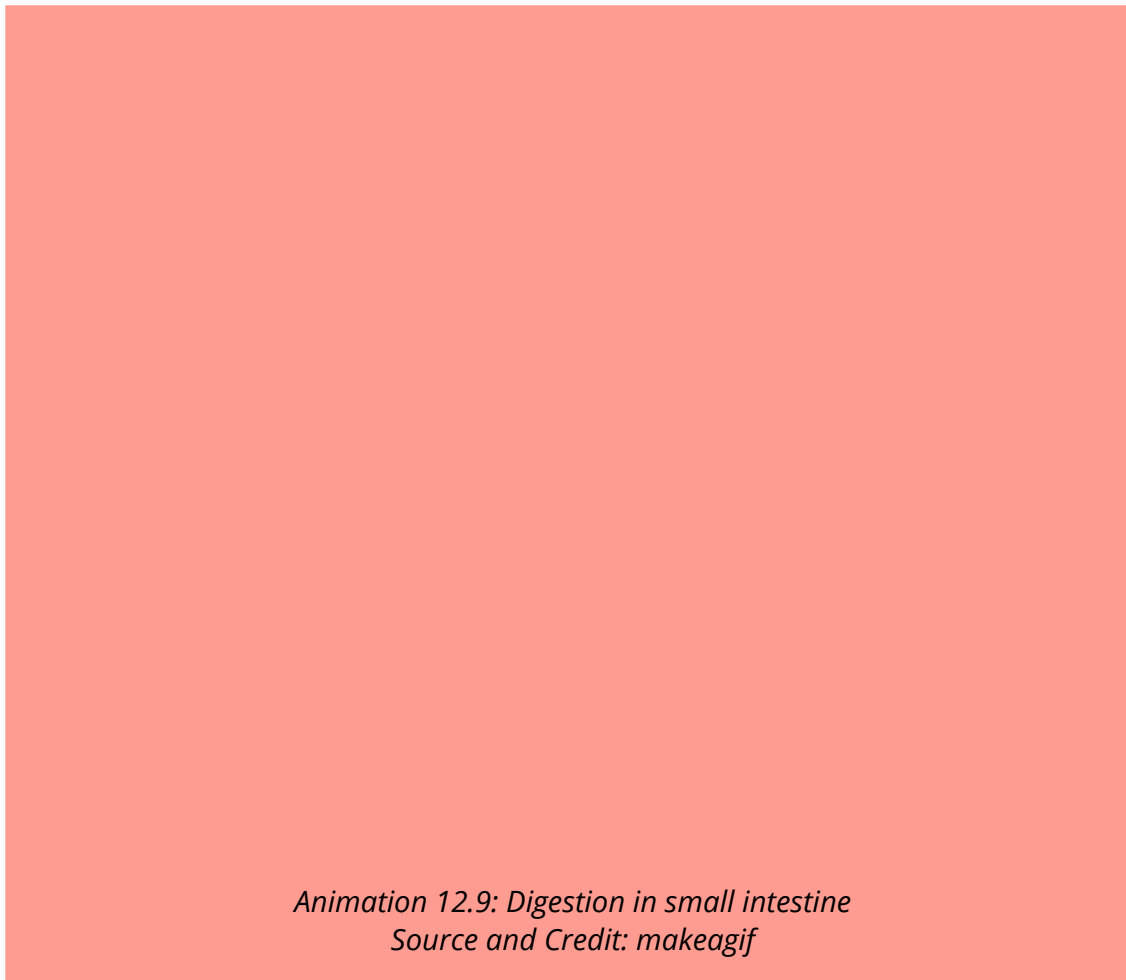

Trypsin splits proteins into peptones and polypeptides. Pancreatic juice also contains sodium bicarbonate, which partly neutralizes the chyme coming from the stomach. This is necessary because enzymes of the pancreas do not work well in acid conditions.

Liver secretes bile, which may be temporarily stored in the gall bladder and released into the duodenum through the bile duct. The bile is green, watery fluid. It contains no enzymes, but its green colour is due to the bile pigments, which are formed from the breakdown of hemoglobin in the liver. The bile also contains bile salts, which act on fats, and emulsifies them. It means that they break them up into small globules, which are then easily digested by water-soluble lipase.

If bile pigments are prevented from leaving digestive tract, they may accumulate in blood, causing a condition known as **jaundice**. Cholesterol, secreted by the liver, may precipitate in the gall bladder to produce **gall stones**, which may block release of bile.

The liver is easily ruptured because it is large, fixed in position, and fragile or it may lacerate by a broken rib. Liver rupture or laceration may result in severe internal bleeding. The liver may become enlarged as a result of heart malfunctioning, hepatic cancer or may be damaged due to hepatitis or being alcoholic.

Jejunum is the second portion of the small intestine extending from the duodenum to the ileum. It is about 2.4 meter in length comprising about two fifth of the small intestine. Lower three fifth of the small intestine from jejunum is the ileum.

The food, which escapes undigested from the duodenum, is completely digested in the jejunum and ileum by a group of enzymes contained in the intestinal juice. The overall picture of enzymes in the human digestive system, their substrates and final products is as follows.

Enzymes	Substrates	Products
Amino peptidase	polypeptides	dipeptides
Erypsin	dipeptides	amino acids
Lipase	fats	fatty acids and glycerol
Maltase	maltose	glucose
Lactase	lactose	glucose and galactose

Absorption of food

As we know that small intestine consists of duodenum, jejunum and ileum. Nearly all absorption of the products of digestion takes place in the ileum. The internal surface of ileum has many folds, which exhibit velvety appearance due to the presence of numerous finger-like outgrowths called **villi** (Fig. 12.17 a & b). Each villus is richly supplied with blood capillaries and a vessel called lacteal of lymphatic system with a covering of epithelial cells. Electron microscope reveals that these cells have countless, closely packed cylindrical processes, **microvilli** (Fig. 12.17 c). The total area of absorption becomes incredibly large due to the enfolding, villi and microvilli. Simple Sugars and amino acids are absorbed by diffusion or active transport into the blood capillaries through the microvilli. Some of the fatty acids and glycerol are also absorbed into blood stream. However, a large proportion of fatty acids and glycerol enter the epithelial cells of villi, where they recombine into fats. These fats then enter the lacteals. Proteins present in lymph vessels combine with fat molecules to form lipoprotein droplets. These pass into blood stream via thoracic lymphatic duct. The lipoproteins are subsequently hydrolysed by blood plasma enzyme and enter body cells, where they may be used in respiration or stored as fat in the liver, muscle of under the skin.

Many humans develop intestinal gas and diarrhoea from consuming milk product, because they lack the enzymes for digesting lactose in milk. The epithelial cells of villi are constantly shed into intestine. These cells are replaced by the new cells moving up due to rapid cell division in crypts (Fig. 12.17)

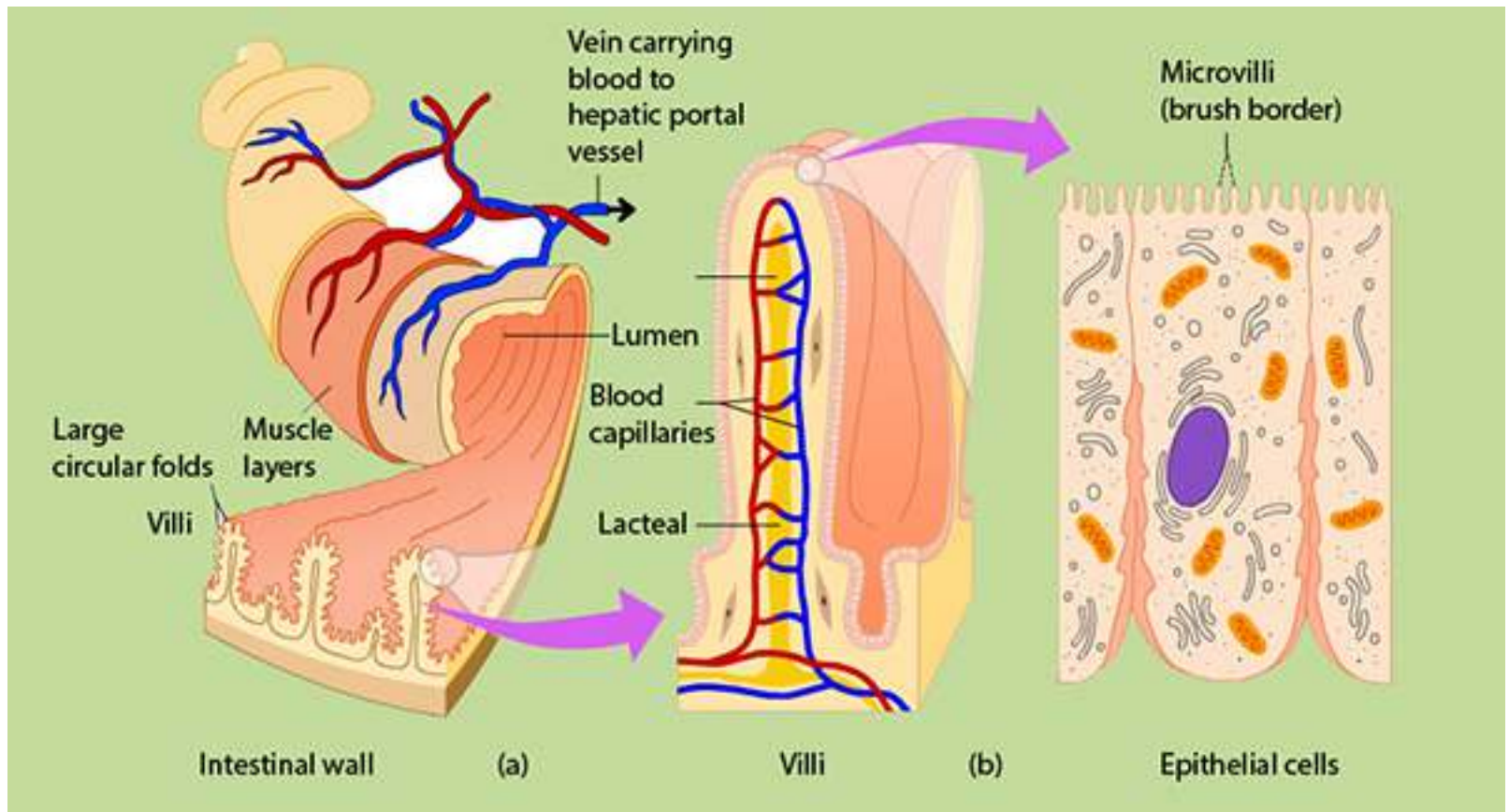
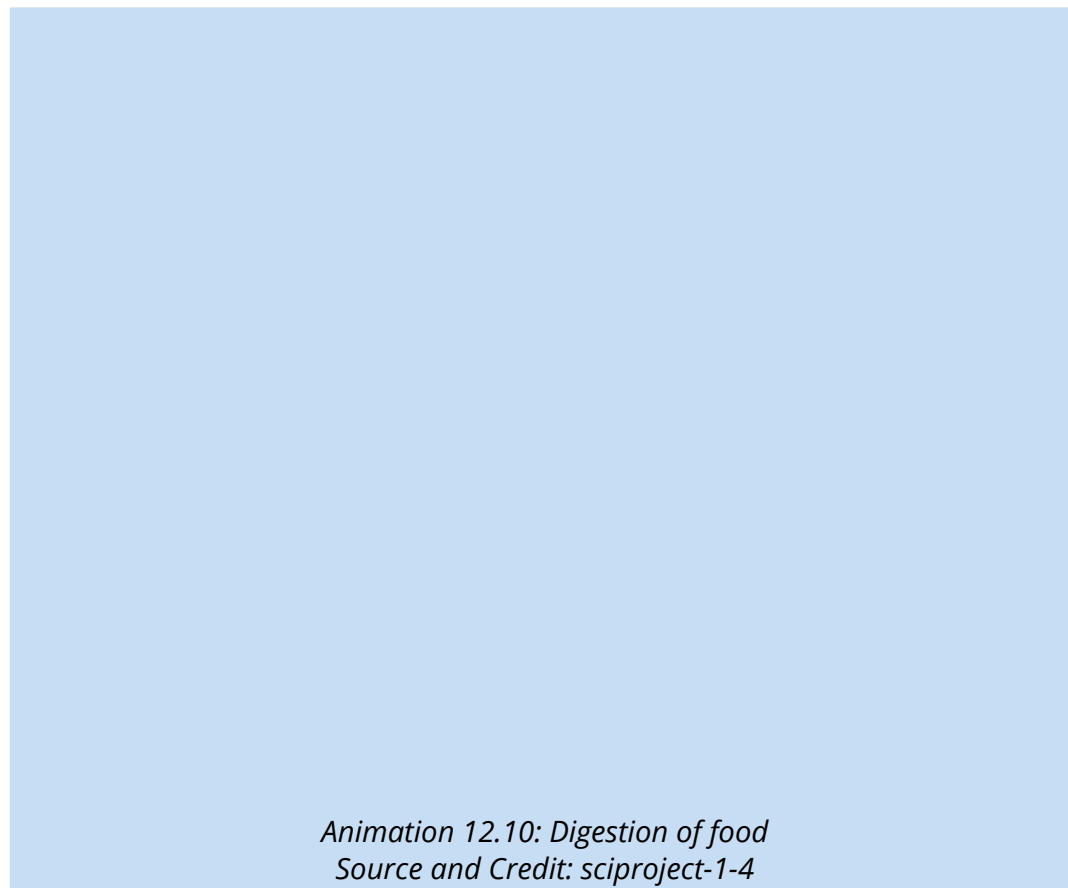
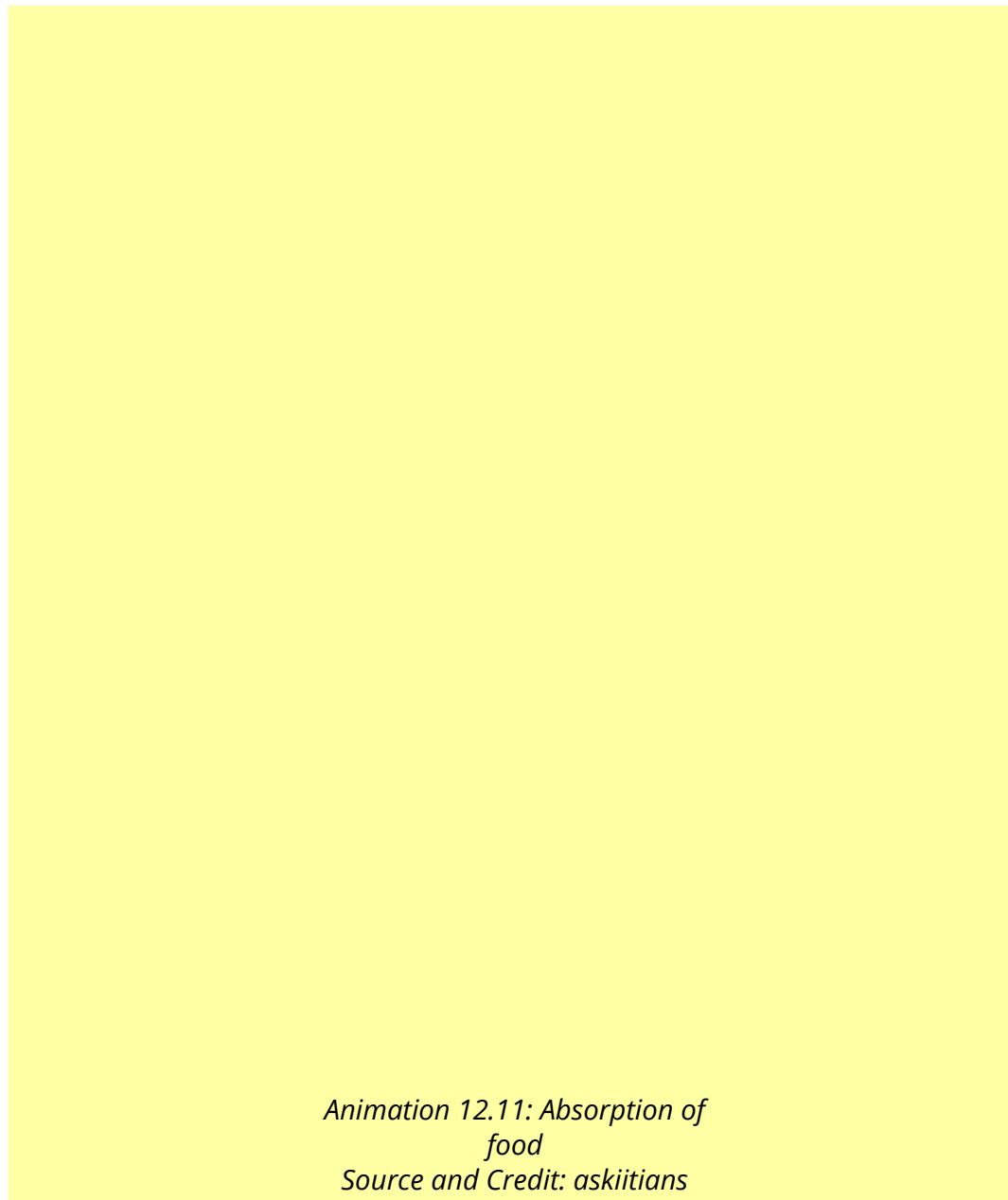

Fig. 12.17. (a) Part of wall of small intestine showing glands and villi.
(b) Detail of villus structure.





The intestinal contents are pushed along the alimentary canal by normal peristaltic activity. At the end of ileum, there is an ileocolic sphincter that opens and closes time to time to allow a small amount of residue from the ileum to enter the large intestine.

Large intestine : The large intestine is composed of a caecum, colon and rectum. Caecum is a blind sac that projects from the large intestine between ileum and colon. From the blind end of the caecum there arises a finger like process called **appendix**. The appendix, some times gets inflamed due to entrapping and then purification of food causing **appendicitis**, which has to be removed surgically in many instances.

The material that passes from the small intestine to the large intestine contains a large amount of water, dissolved salts and undigested material. Water and salts are absorbed into blood, while undigested material is rejected as feces. The fecal matter contains a large number of bacteria, plant fibers, sloughed off mucosal cells, mucus, cholesterol, bile pigments and water. Large intestine also harbors a large population of useful bacteria that synthesize some vitamins especially vitamin K, which are absorbed in blood. If the absorption of water and salts does not take place due to infection, drug action or emotional disturbance, a condition known as **diarrhoea** occurs. If this condition is unchecked, dehydration develops that may prove to be fatal. The other extreme condition is **constipation**, which is caused by the excessive absorption of water.

Rectum is the last part of large intestine, where feces are temporarily stored and rejected through anus, at intervals. Anus is surrounded by two sphincters, the internal is of smooth and outer of striped muscles. Under normal conditions, as the rectum is filled up with feces, it gives rise to defecation reflex. This reflex can be consciously inhibited in individuals other than infants. Gradually the child learns to bring this reflex under control.

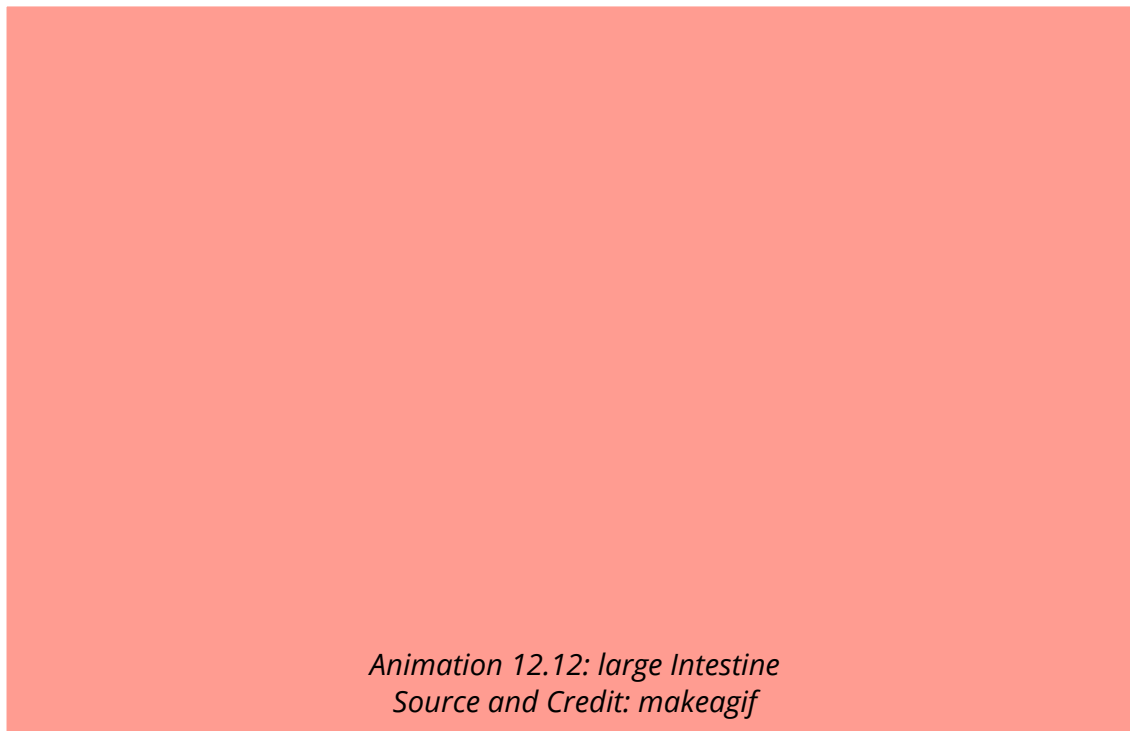

Table 12.1 Functions of The Digestive Organs

Organ	Function	Secretion
Oral Cavity Teeth Lips and cheeks Tongue	Mastication (cutting and grinding of food); communication. Manipulation of food; hold food in position between the teeth; communication. Manipulation of food; holds food in position between the teeth; cleansing teeth; taste	None Saliva from buccal glands (mucus only). Some mucus; small amount of serous fluid.
Salivary Glands Parotid gland Submandibular glands Sublingual glands	Secretion of saliva through ducts to <i>posterior portions of oral cavity</i> . Secretion of saliva in floor of oral cavity. Secretion of saliva in floor of oral cavity.	Saliva with amylase Saliva, with amylase mucus Saliva with mucus only.
Pharynx	swallowing	Some mucus
Esophagus	Movement of food by peristalsis from pharynx to stomach	Mucus
Stomach Mucous cells Parietal cells Zymogen cells Endocrine cells	Mechanical mixing of food; enzymatic digestion; storage; absorption. Protection of stomach wall by mucus production Decrease in stomach pH. Protein digestion. Regulation of secretion and motility.	Mucus Hydrochloric acid. Pepsinogen Gastrin

Accessory Glands		
Liver	Secretion of bile into duodenum	Bile
Gallbladder	Bile storage; absorbs water and electrolytes to concentrate bile.	No secretions of its own, stores and concentrates bile.
Pancreas	Secretion of several digestive enzymes and bicarbonate ions into duodenum.	Trypsin, chymotrypsin, pancreatic amylase, pancreatic lipase, bicarbonate ions.
Small Intestine		
Duodenal glands	Protection	Mucus
Goblet cells	Protection	Mucus
Absorptive cells	Secretion of digestive enzymes and absorption of digested materials.	Enterokinase, amylase, peptidases, sucrase, maltase, lactase, lipase.
Endocrine cells	Regulation of secretion and motility.	Gastrin, secretin,
Large intestine		
Goblet cells	Absorption, storage, and food movement. Protection	Mucus

SOME COMMON DISEASES RELATED TO NUTRITION

Dyspepsia

Incomplete or imperfect digestion is called **dyspepsia**. This is not a disease in itself but symptomatic of other disorders or diseases. This is characterized by abdominal discomfort, flatulence, heartburn, nausea and vomiting. These symptoms may occur irregularly and in different patterns from time to time. Dyspepsia may occur due to excessive acidity in stomach or faulty function of stomach and intestine or insufficient quality or quantity of bile secretions.

Food poisoning

This term indicates an illness from indigestion of food containing toxic substances. One of the commonest causes of food poisoning are the toxins produced by bacteria, Salmonella and Campylobacter. These bacteria live in the intestines of cattle, chicken and duck without causing disease symptoms. Humans, however, may develop food poisoning if they drink milk, eat meat or eggs which are contaminated with these bacteria. The symptoms of food poisoning are diarrhoea, vomiting and abdominal pain. They occur from 12-24 hours after eating contaminated food. Infection is most likely, if unpasteurized milk is drunk or if meat is not properly cooked.

The liquid that escapes during defrosting frozen meat contains Salmonella bacteria. The dishes and utensils while the meat is defrosting must not be allowed to come in contact with any other food.

A severe form of food poisoning is **botulism**. This is caused by toxins produced by bacteria known as *Clostridium botulinum*. Botulism develops by the use of improperly canned or otherwise preserved foods, especially meat. The toxin produced by these bacteria is very powerful and has selective action on central nervous system, causing cardiac and respiratory paralysis. The early symptoms of this diseases are fatigue, dizziness, double vision, headache, nausea, vomiting, diarrhoea and abdominal pain.

Obesity

It is the term employed when a person has abnormal amount of fat on the body. If one eats too much food than body requirement, the surplus is stored as fat so becomes overweight or **obese**. There is fat stored in **adipose tissue** in the abdomen, around the kidneys and under the skin. Certain cells accumulate drops of fat in their cytoplasm. As these drops increase in size and number, they join together to form one large globule of fat in the middle of the cell, pushing the cytoplasm into thin layer and the nucleus to one side. Groups of fat cells form adipose tissue. Some people never seem to get fat no matter how much they eat, while others lay down fat when their intake only just exceeds their need. The explanation probably lies in the balance of hormones which, to some extent, is determined by heredity. An obese person is much more likely to suffer from high blood pressure, heart disease, diabetes mellitus, stomach disorder than a person who has normal body weight.

Anorexia Nervosa

This term is employed to the loss of appetite due to the fear of becoming obese. Such a feeling is common in human females between the age of 12 and 21 years. Fear does not diminish even when weight is dropped to dangerous level. Psychiatric therapy is usually required when patient refuses to eat.

Anorexia is an illness which largely affects girls usually just after the onset of puberty. The illness is characterized by the loss of appetite due to the fear of becoming obese. An anorexic girl over estimates the size of her own body and so insists that she is over weight when in reality her weight has dropped to a dangerous level. These girls are often immature psychologically and unable to cope with the challenges of puberty and their emerging sexuality. The loss of feminine characteristics enable the girls to retreat into a child like state in which they feel safe. Psychiatric therapy is usually required to treat anorexic girls. Such patients are fed through any route other than alimentary canal that is intramuscularly or intravenously. The recovery is very slow. It may take 2-4 years and in some cases longer.

Bulimia Nervosa

It is neurotic disorder in slightly older girls. It is characterized by bouts of over eating fattening food such as fried food or cream cakes. This voracious eating is followed immediately by self-induced vomiting, fasting or purgatives. The frequent vomiting and purging may cause physical effects including **serum electrolyte** imbalance and frequent recurring infections. Treatment of bulimics is likely to be prolonged. The initial treatment is to overcome the effects of weight loss and malnutrition. It is necessary to undertake the treatment in hospital under strict supervision.

Piles

Piles or hemorrhoids are masses of dilated, tortuous veins in the anorectal mucosa. These masses may some times start bleeding during bowel movements. Situation may aggravate when the patient suffers from constipation. The urge to defecate is depressed and it becomes difficult to expel the faeces. This may cause other symptoms of ill health because of the physical distension of the rectum. The only therapy required is the improvement of the hygiene and the use of food softeners, such as roughage, in food or laxatives. The patients are advised not to sit on hard seats. Depending on severity of the symptoms, sometimes the hemorrhoids have to be removed surgically

Ulcer

The inner wall of digestive tract is normally covered with mucus, which protects it from enzymes. When the mucus layer breaks down the digestive enzymes begin to eat away the walls of stomach or duodenum. This results in a sore called ulcer. Occasionally, an ulcer is so severe that a hole develops in the wall of the digestive tract and the contents of the tract spill into the abdominal cavity, leading to severe infections which may prove to be fatal, if immediate medical care is not sought.

Excessive secretion of gastric acid secretion is an important factor of peptic ulcer. Smoking, spicy food, alcoholic beverages, coffee, tea and stress should be avoided by the patients suffering from ulcer.

EXERCISE

Q.1 Fill in the blanks

- (i) Plants absorb minerals in their _____ form, as found in the soil.
- (ii) In plants the most common nutrient deficiencies are of _____ , _____ and _____ .
- (iii) A plant requires _____ for holding its cell together.
- (iv) Most of the organic material in a plant is _____ .
- (v) Chlorosis is usually caused by insufficient _____ .
- (vi) In _____ the trapped insects are decomposed by bacteria.
- (vii) The structure in the mouth that prevents food from entering the nasal cavities is the _____ .
- (viii) The stomach functions to _____ a food and its _____ .
- (ix) _____ is the common example of detritivore.
- (x) Pancreas produces _____ which stimulates the conversion of glycogen to _____ .
- (xi) Vomiting occurs due to _____ movements.

Q.2 Short Questions

- (i) What is the advantage of a digestive tract as compared with a digestive cavity?
- (ii) What are functions of human liver?
- (iii) What measures should be taken to avoid food poisoning?

- (iv) Can we get along without large intestine? if not why?

Q.3 Extensive questions

- (i) Define nutrition. Describe the role of different elements in plant nutrition.
- (ii) a) Distinguish between saprophytic and parasitic modes of life, (b) i. Name one parasitic plant, ii. Describe its method of nutrition, explaining why normal nutrition is not possible.
- (iii) What are heterotrophs? Describe different methods of nutrition in heterotrophs.
- (iv) What are the advantages and disadvantages of the parasitic mode of life compared with that of a free living organism.
- (v) Why is digestion necessary? Describe what happens to a meal containing fats, carbohydrates and proteins while it is in the stomach of man.
- (vi) What is holozoic nutrition? Describe the characteristics processes involved in holozoic nutrition giving the example of Amoeba.
- (vii) How do (i) the saliva, (ii) the pancreas, (iii) the liver help in the digestion of the food of man? Draw a diagram of the digestive system to show the positions of the pancreas and the liver.
- (viii) Make a labelled diagram of the alimentary and digestive glands in cockroach. What are the functions of the glands you sketch?
- (ix) Describe the structure and functions of human stomach.
- (x) How do the digestive tract of herbivores differ from those of carnivores?
- (xi) What prevents the wall of stomach from being digested?
- (xii) What specialized features of your small intestine account for the efficient absorption of digested foodstuffs?

- (xiii) What is the contribution of liver and pancreas in the process of digestion?
- (xvi) How can we control obesity?
- (xv) How is gastric juice production regulated?

CHAPTER

13

Gaseous Exchange

Animation 13.1: Gaseous Exchange
Source & Credit: Wikispaces

NEED OF RESPIRATORY GAS EXCHANGE

At all levels of activities in living organisms an uninterrupted supply of energy is required. Respiration is one of the most important metabolic activities of all organisms. Respiration occurs at two levels, i.e, organismic and cellular level. Organismic respiration is also known as breathing or ventilation. The cellular respiration is directly involved in the production of energy, necessary for all living activities. Cellular respiration is the process by which cell utilizes oxygen, produces carbon dioxide, extracts and conserves the energy from food molecules in biologically useful form, such as, ATP.

ADVANTAGES AND DISADVANTAGES OF GAS EXCHANGE IN AIR AND IN WATER

Exchange of gases during organismic respiration is carried out only by diffusion. Respiratory gases are exchanged between body fluid and outside medium which may be water or air. There is no active transport mechanism to move respiratory gases across biological membranes. For that matter, air is better respiratory' medium than water. Oxygen can be obtained more easily from air than from water because of many reasons.

Firstly, the oxygen content of air is much higher than the oxygen content of equal volume of water. A liter of water cannot contain even 10 ml of oxygen whereas oxygen content of fresh air is about 200 ml per liter. Secondly, oxygen diffuses about 8000 times more quickly in air than in water.

Breathing or ventilation is directly involved in the exchange of gases .The ventilation of water is far more difficult than the ventilation of air, because water is 8000 times more dense than air .In terms of viscosity the water is 50 times more viscous, which makes it more difficult for exchange of gases as compared to air.

GASEOUS EXCHANGE IN PLANTS

Plants like animals also get their energy from respiration. In plants, in contrast to animals, no special organ or system is present for gaseous exchange as they exist in higher animals. Every cell of plant carries out exchange of gases according to its needs. The transport system of plants which includes conducting tissues i.e. xylem and phloem is not involved in the transport of gases in the plants. In most cells of mesophyll which are specialized for photosynthesis, there are present large air spaces. These air spaces are directly involved in gaseous exchange. Stomata are the main sites of exchange of gases in plants. Stomata are largely present in the leaves and in young stem. In older stems, cork tissue is present which is formed of dead cells. The cork tissue has special pores called lenticels which are involved in gaseous exchange. Land plants get their oxygen directly from air which enters through stomata. Enormous number of stomata are present on the leaves. It is estimated that there are 12000 stomata per square centimeter of leaf surface in Tobacco plant. These stomata lead to the intercellular spaces (spaces between cells) of mesophyll tissue. The air spaces are comparable to honey comb. These air spaces may comprise up to 40% of the total volume of the leaf. The exchange of gases between and the moist surface of mesophyll cells takes place promptly (Fig 13.1). The roots of the land plants get their oxygen from the air existing in the spaces between the soil particles. Aquatic plants obtain their oxygen by diffusion from dissolved oxygen in water.

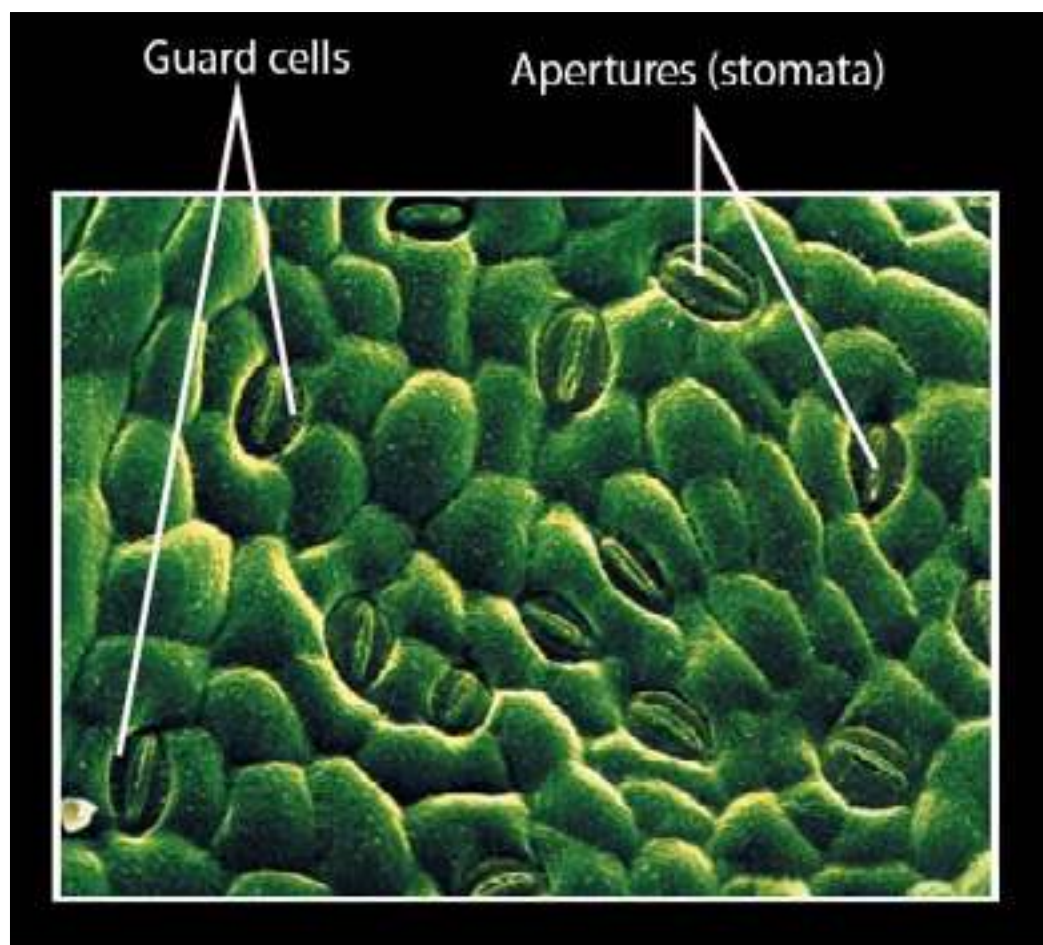

Fig. 13.1 Stomata on leaf surface

Photorespiration and its Consequences

Respiratory activity which occurs in plants during daytime is called **photorespiration**. In the process of photorespiration carbon dioxide is released and oxygen is absorbed. The oxygen absorbed is not useful to produce energy such as ATP. In other words photorespiration is a light dependent process during which oxygen is absorbed and carbon dioxide is released. This oxygen is derived from the early reaction of photosynthesis.

The photorespiration is a process in which ribulose biphosphate carboxylase/oxygenase (rubisco) fixes oxygen instead of carbon dioxide which results in lowering the overall rate of carbon dioxide fixation and plant growth.

Ribulose 1,5 biphosphate (RuBP) reacts with oxygen in photorespiration

The first step of photorespiration during which RuBP reacts with oxygen is carried out by rubisco, the most abundant protein in chloroplasts and probably the most abundant protein in the world. The rubisco is carboxylase as well as oxygenase. When rubisco acts as carboxylase it adds carbon dioxide to RuBP, which is an acceptor molecule. On the other hand when rubisco is oxygenase it adds oxygen to RuBP. Both these reactions compete with each other. When RuBP reacts with oxygen, a two carbon compound glycolate is produced.



The glycolate thus produced diffuses into the membrane bounded organelles known as **peroxisomes**. In the peroxisomes the glycolate is converted into glycine, through a series of reactions.



The glycine is the simplest amino acid which soon after its formation diffuses into the **mitochondria** where two glycine molecules are converted into serine and synthesis a molecule of carbon dioxide is formed.



The pathway in which RuBP is converted into serine is called photorespiration. The process of photorespiration uses ATP and NADPH produced in the light reactions just like **Calvin-Benson cycle**. But, in fact, photorespiration is reverse of Calvin cycle. During photorespiration carbon dioxide is released instead of fixation into carbohydrates. In most plants photorespiration reduces the amount of carbon fixed into -carbohydrates by 25%.

In a hot and dry day the level of oxygen inside the leaf rises. This is because the stomata close to prevent the loss of water. The level of carbon dioxide falls because it is being consumed and the level of oxygen rises because closed stomata do not let it go out.

It is interesting that apparently the photorespiration reduces the photosynthetic process and it is not essential for plants and many plants grow normally without the process of photorespiration. It is also observed that if photorespiration is inhibited chemically, the plant can, still grow. Then why does photorespiration exist? The common simple answer to this question is that the active site of rubisco is evolved to bind both carbon dioxide and oxygen together. Originally it was not a problem as there was little oxygen in the atmosphere and the carbon dioxide binding activity was the only one used. The photorespiration started when the quantity of oxygen became more.

RESPIRATORY ORGANS IN REPRESENTATIVE AQUATIC AND TERRESTRIAL ANIMALS

Properties of respiratory surfaces in animals

Respiratory surfaces in animals are the sites where gaseous exchange takes place. The respiratory surfaces in most animals exhibit the following features :

1. Large surface and moisture:

The surface area should be extremely large and kept moist as it is seen in the lungs in the land vertebrates and in the gills in the case of fishes.

2. Thin epithelium:

The distance across which diffusion has to take place should be little. In most animals the epithelium which separates air and blood is only two cell thick. As a result the distance for diffusion is very short.

3. Ventilation:

Ventilation maintains a steep diffusion gradient. There is a big difference in the concentration of the gases at two points which brings about diffusion.

4. Capillary network:

The respiratory site should possess extensive network of capillaries through which blood should flow all the time at an adequate speed. In this way steep diffusion gradient is maintained which helps in rapid diffusion of oxygen.

Respiration in Hydra

Hydra has no specialized organs for respiration. Exchange of gases i.e., intake of oxygen and removal of carbon dioxide, occurs through the entire general surface in contact with water. Exchange of oxygen in and carbon dioxide out also occurs in cells lining the digestive cavity. In this way the surface lining of the enteron acts, as an efficient respiratory surface (Fig. 13.2).

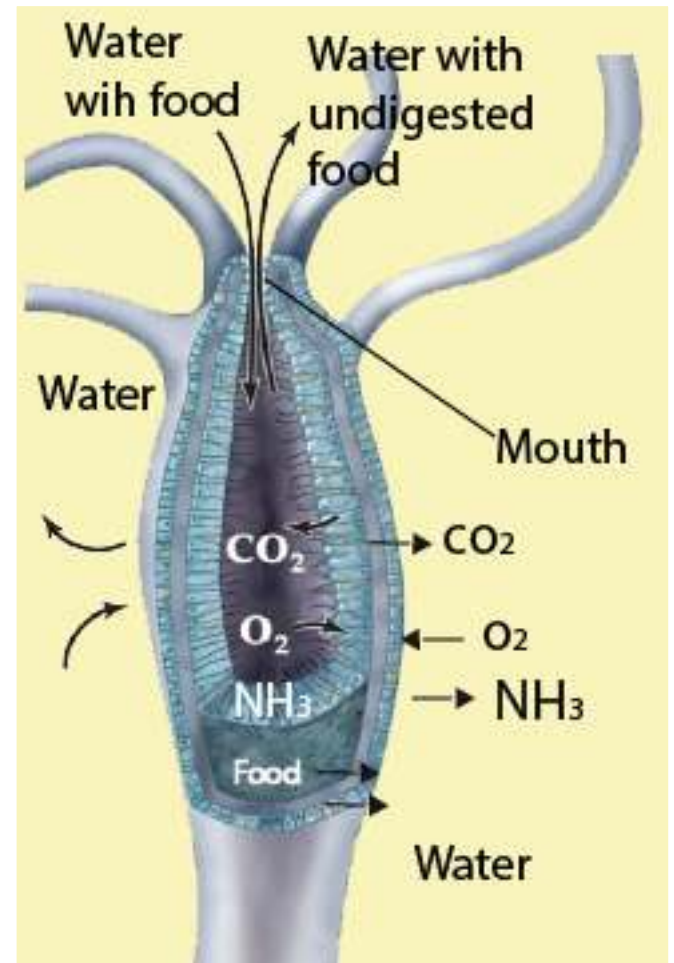
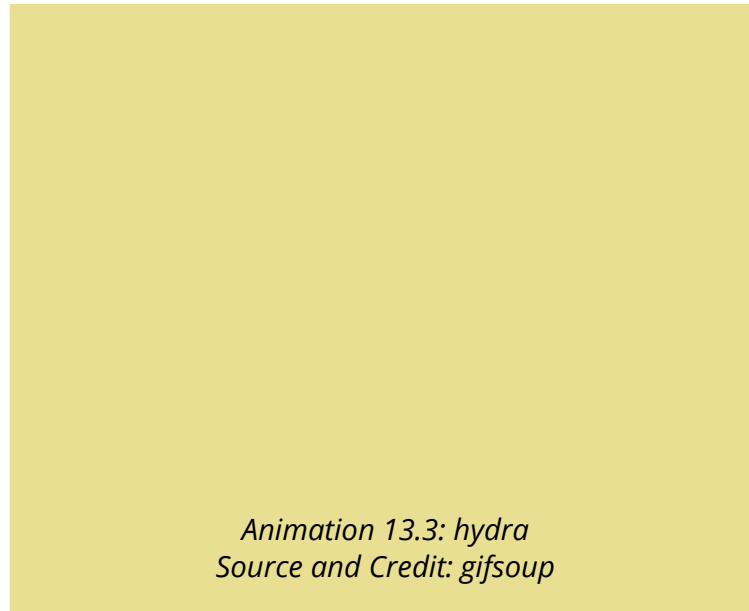

Fig 13.2 Respiration in Hydra

Animation 13.2: Hydra
Source and Credit: carnivoraforum



*Animation 13.3: hydra
Source and Credit: gifsoup*

Respiration in Earthworm

Although earthworm is much complex than hydra, yet it does not have any specialized respiratory organs. The exchange of gases occurs mainly through skin. Skin is richly supplied with blood capillaries and is always kept moist by the secretion of epidermal mucous gland cells and also by coelomic fluid exuding out through the dorsal pores. Oxygen dissolved on the wet surface passes through the cuticle and epidermal cells into the blood. In the blood, oxygen combines with haemoglobin to form oxyhaemoglobin. Oxyhaemoglobin releases up oxygen at the tissue level. In earthworm, blood does not come into direct contact with tissue cells so oxygen must diffuse through the tissue fluids and coelomic fluids. Carbon dioxide is removed from the tissues by the blood and carried in the plasma to skin, from where it is excreted ((Fig. 13.3)

*Animation 13.4: Respiration in Earthworm
Source and Credit: waterwereld*

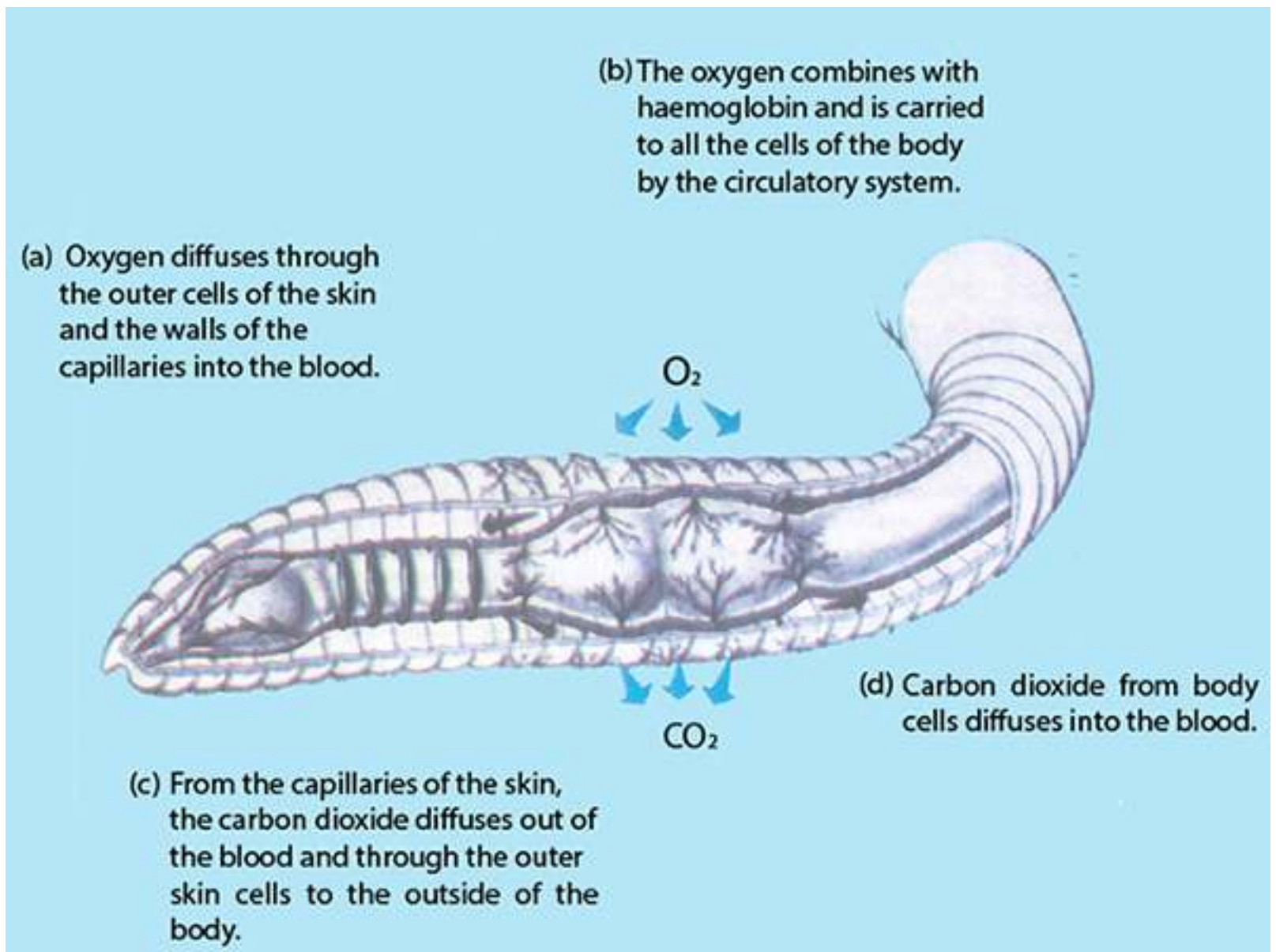

Fig. 13.3 Respiration in Earthworm

RESPIRATION IN COCKROACH

Cockroach has specialized organs for respiration. The respiratory system of the cockroach is very specialized. It consists of branching systems of air tubules called tracheae lined by chitin. The main tracheal trunk communicates with exterior by 10 pairs of apertures called **spiracles**, present on the lateral sides of the body. Two pairs are in thorax while the rest eight are in each of the eight

abdominal segments. The main tracheae divide and subdivide forming very fine thin-walled tubules called **tracheoles**. These tracheoles end into blind ducts partly filled with fluid, in which the oxygen dissolves. These surround the organs and the tissues and directly supply oxygen to the living cells. A concentration gradient is set up between them and the spiracular openings and oxygen diffuses into the trachea from the outside air. The movement of the air through the tracheal trunks transfers gases through inspiration and expiration. Air is pumped in and out of the tracheae by the expansion and contraction of the abdominal muscles (Dorsoventral muscles). When abdomen expands, the first four pairs of spiracles open, air rushes in through these spiracles into tracheoles. Abdomen contracts, the anterior four pairs of spiracles close and posterior six pairs of spiracles open. This forces air through the tubes and eventually out of the body. In this way exhalation and inhalation take place. From the spiracles air enters into trachea and then tracheole, from where gaseous exchange between tissue cells and air in tracheole takes place. Thus air is directly supplied through tracheoles to the tissue cells. Blood is not involved in transport of gases (Fig.13.4).

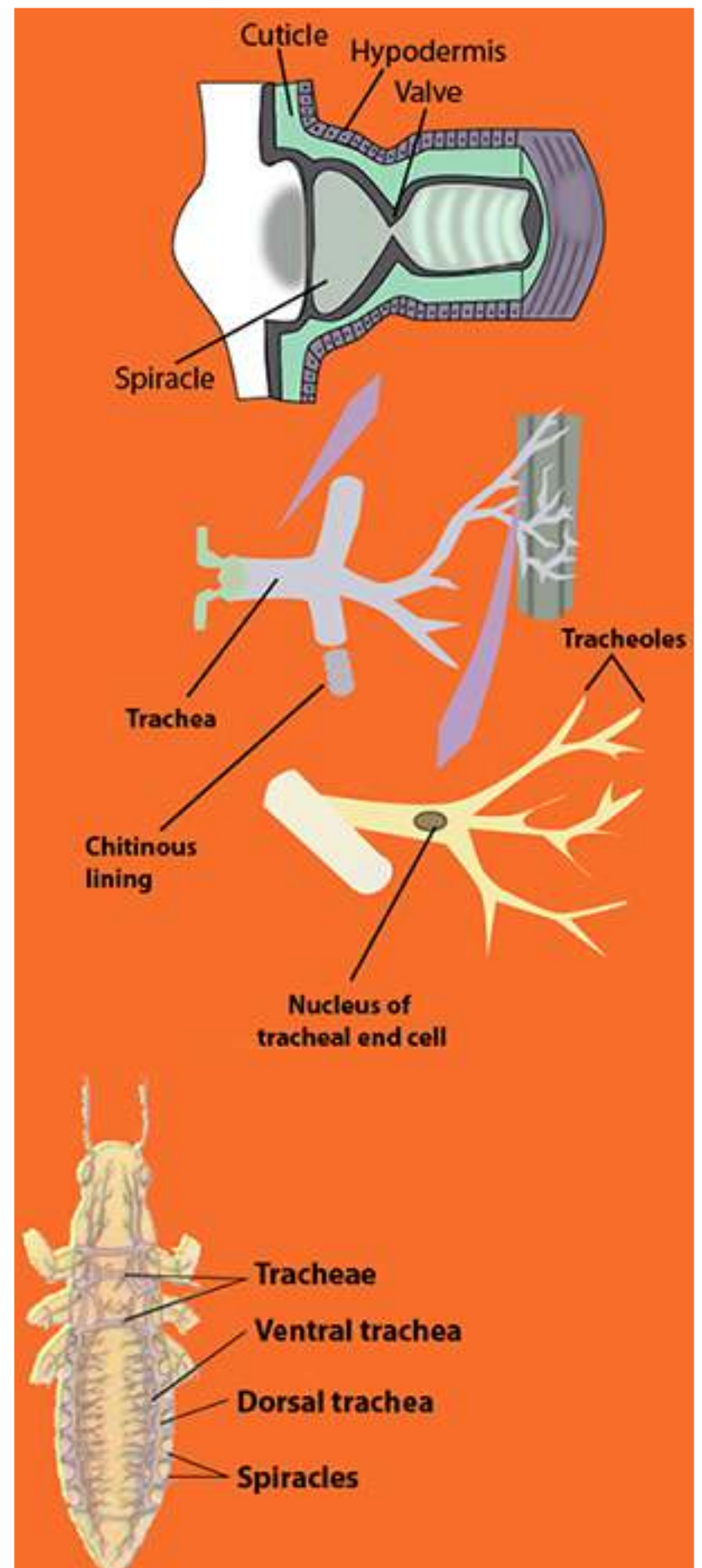
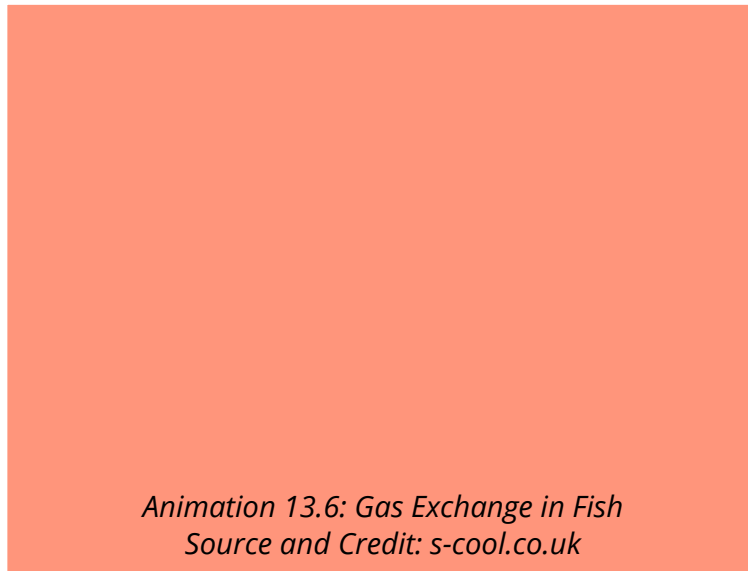

Fig. 13.4 Respiration in Cockroach



*Animation 13.5: COCKROACH
Source and Credit: presentmam*



*Animation 13.6: Gas Exchange in Fish
Source and Credit: s-cool.co.uk*

Respiration in fish

Fish respire through the gills which are paired structures present on either side of the body almost at the junction of head and trunk. Gills are most effective and highly modified for gaseous exchange in aquatic animals. They are in four to five pairs which may open through gill slits and are visible on the surface of the pharynx (cartilaginous fish) or are placed in bronchial cavities which are covered by **operculum**. Gills have great surface area for gaseous exchange. The gill surface is all the time ventilated by constant flow of water. Heart pumps the blood directly to the gills from where oxygenated blood is carried to all the parts of the body. The deoxygenated blood from different parts of the body is received by heart. The heart of the fish is single circuit and the blood flows in only one direction. The blood enters the posterior side of heart and after passing through different chambers it is pumped into the gills. Water enters through the mouth and after passing over the gills move out of the body through the gill openings (Fig. 13.5)

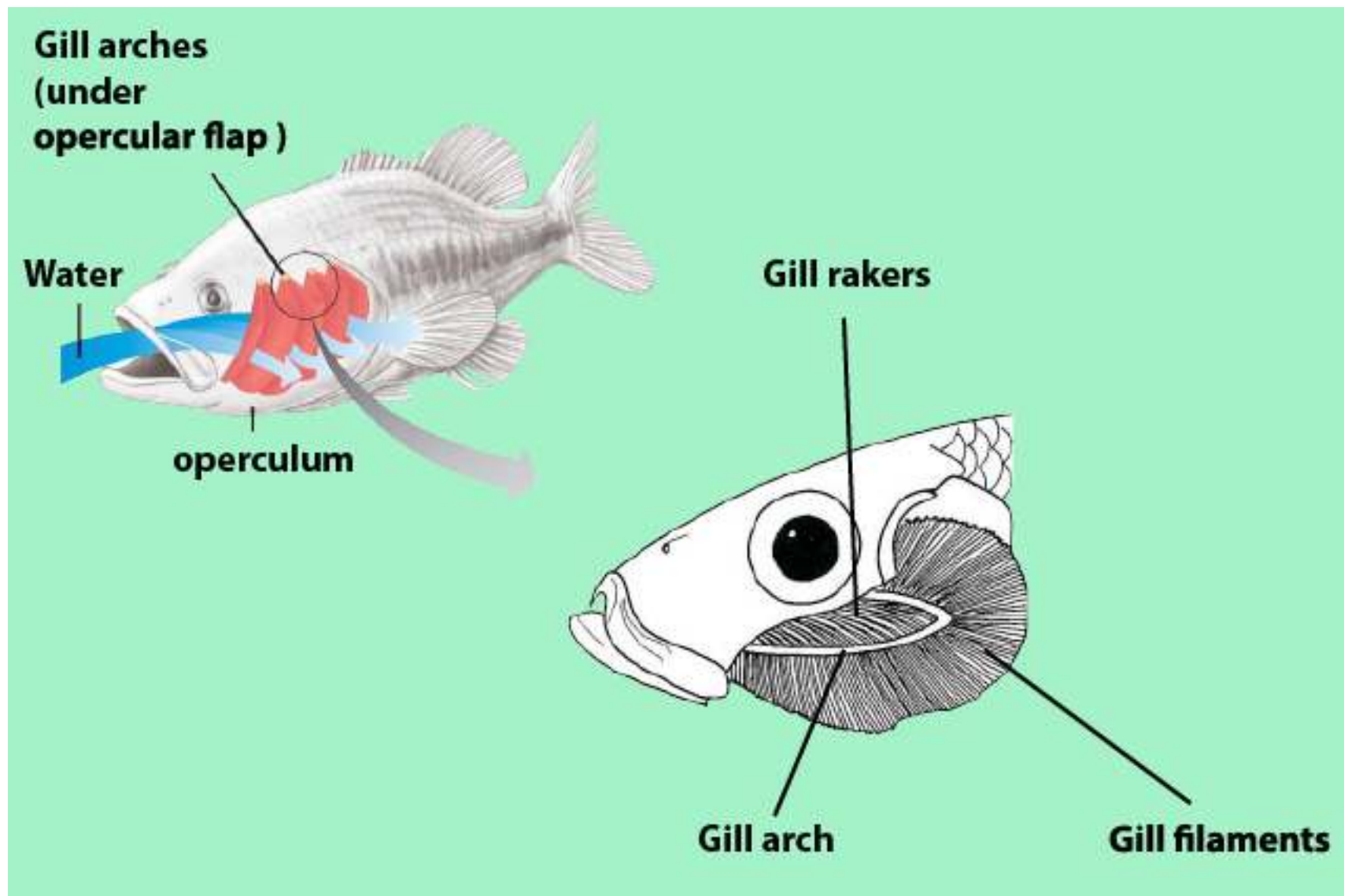

Fig. 13.5 Water flows unidirectionally over the gills of a fish.

Respiration in Frog

In frog, the gaseous exchange occurs through the lungs, by skin, and buccal chamber which are richly supplied with blood vessels. The gaseous exchange through the skin is known as cutaneous respiration.

Gaseous exchange through the lungs is called **pulmonary respiration**. In frog the air enters through the nostrils, when the nostrils are open; the mouth is closed. After entry of air the nostrils close, the floor of buccal cavity is raised, air is pushed into the lungs. This intake of air is known as **inhalation or inspiration**. Expiration occurs exactly in reverse order in sequence of inspiration.

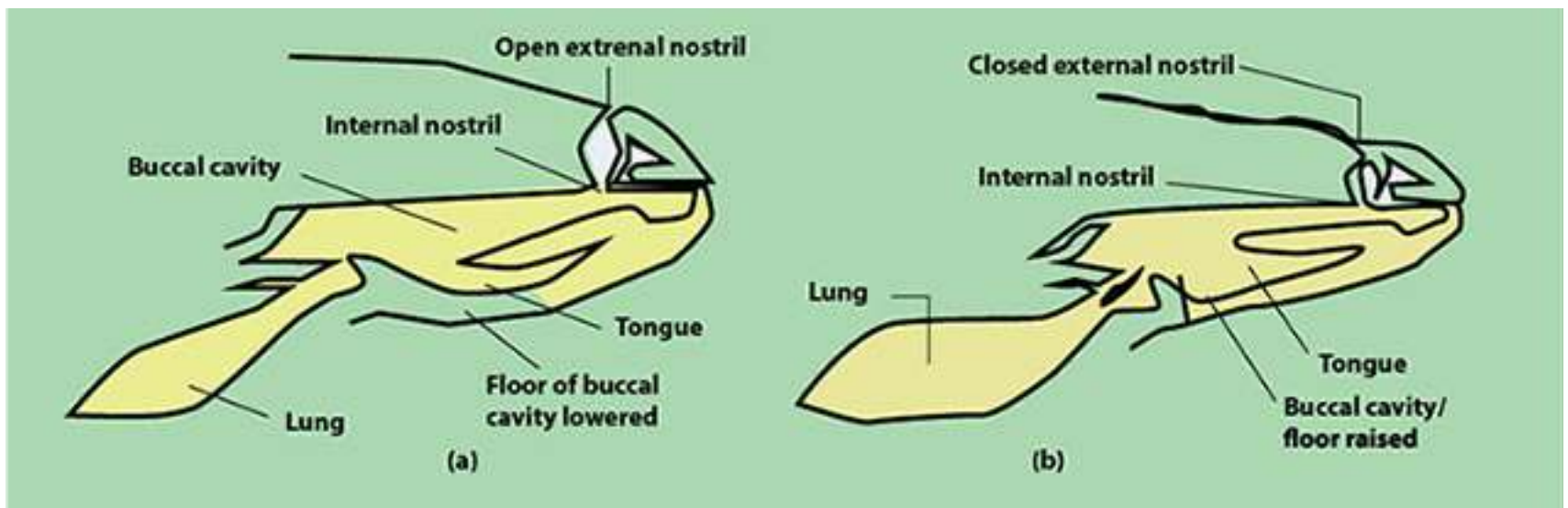
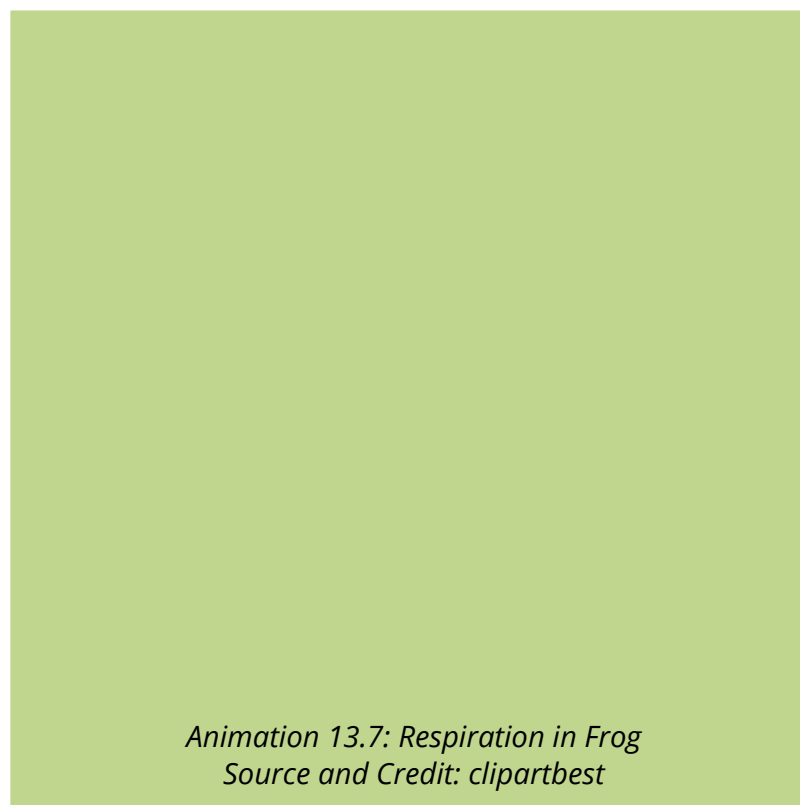

Fig. 13.6 Two stages in inspiration (buccal respiration)



Animation 13.7: Respiration in Frog
Source and Credit: clipartbest

Lungs in frog are simple sacs almost like balloon when they are fully expanded. The inner surface of lung is increased by thin walled air chambers. The walls of these air chambers are richly supplied with capillaries. These blood containing areas in the lungs are the main sites for gaseous exchange. The consumed air after gaseous exchange moves out of the lungs through the nostrils. The removal of consumed air out of the lungs, after gaseous exchange has occurred, is called **exhalation or expiration** (Fig. 13.6).

Respiration in birds

Respiratory system in birds is the most efficient and elaborate. The birds are very active animals with high metabolic rate, and thus need large amount of oxygen. The respiratory system in the birds is so arranged that there is one way flow of the air through the lungs and the air is renewed after inspiration. In the lungs of birds, tiny thin walled ducts called **parabronchi** are present instead of alveoli. These parabronchi are open at both ends and the air; is constantly ventilated. The walls of the parabronchi are chief sites of gaseous exchange. The direction of the blood flow in the lungs is opposite to that of the air flow through the parabronchi. This counter current exchange increases the amount of oxygen which enters blood. Lungs in birds are very efficient in this respect as well, because no stale of air remains in the parabronchi.

The lungs have also developed several extensions known as air sacs which reach all parts of the body and even penetrate some of the bones. In most birds the air sacs are nine in number which become inflated by air at atmospheric pressure when the rib articulations are rotated forward and upward. The inflated air sacs act as bellows and send air into the parabronchi for gaseous exchange.

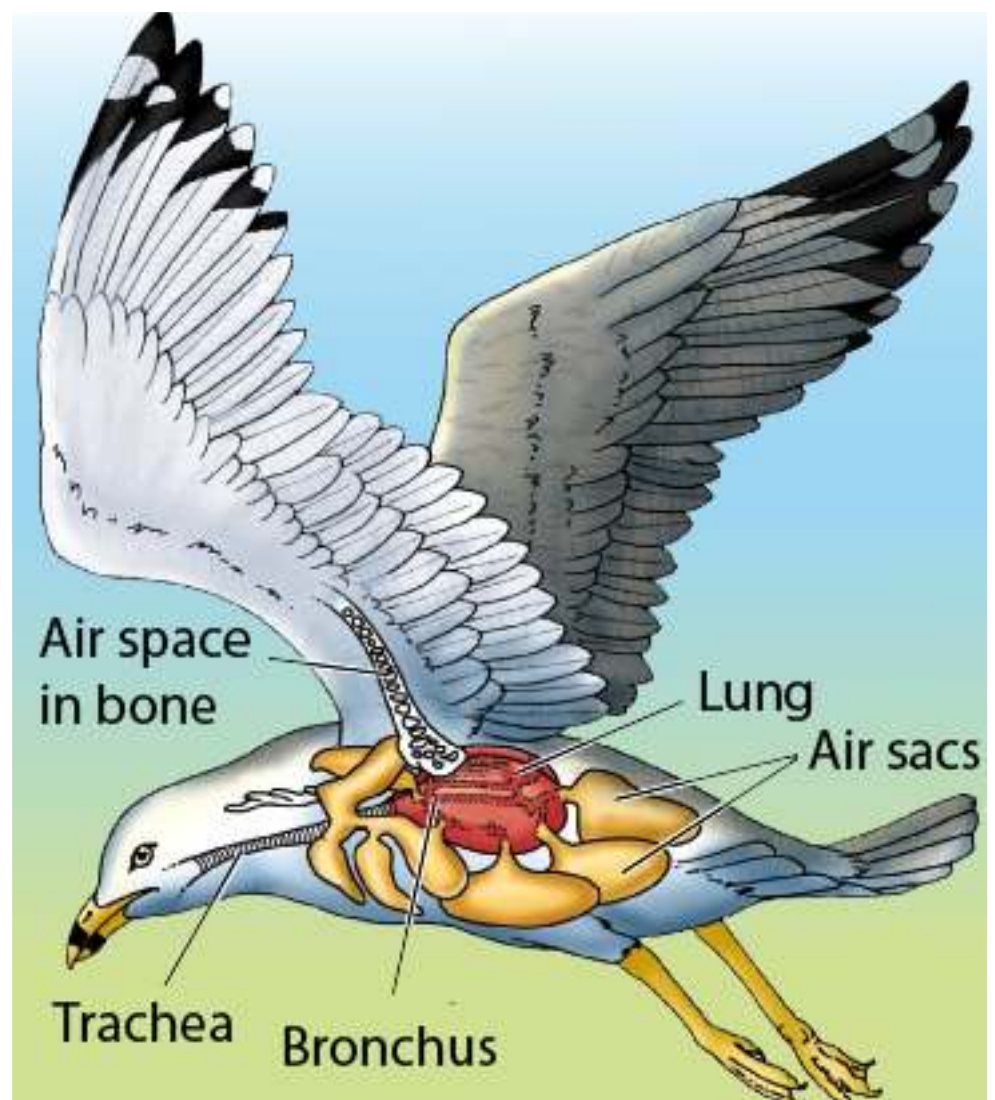
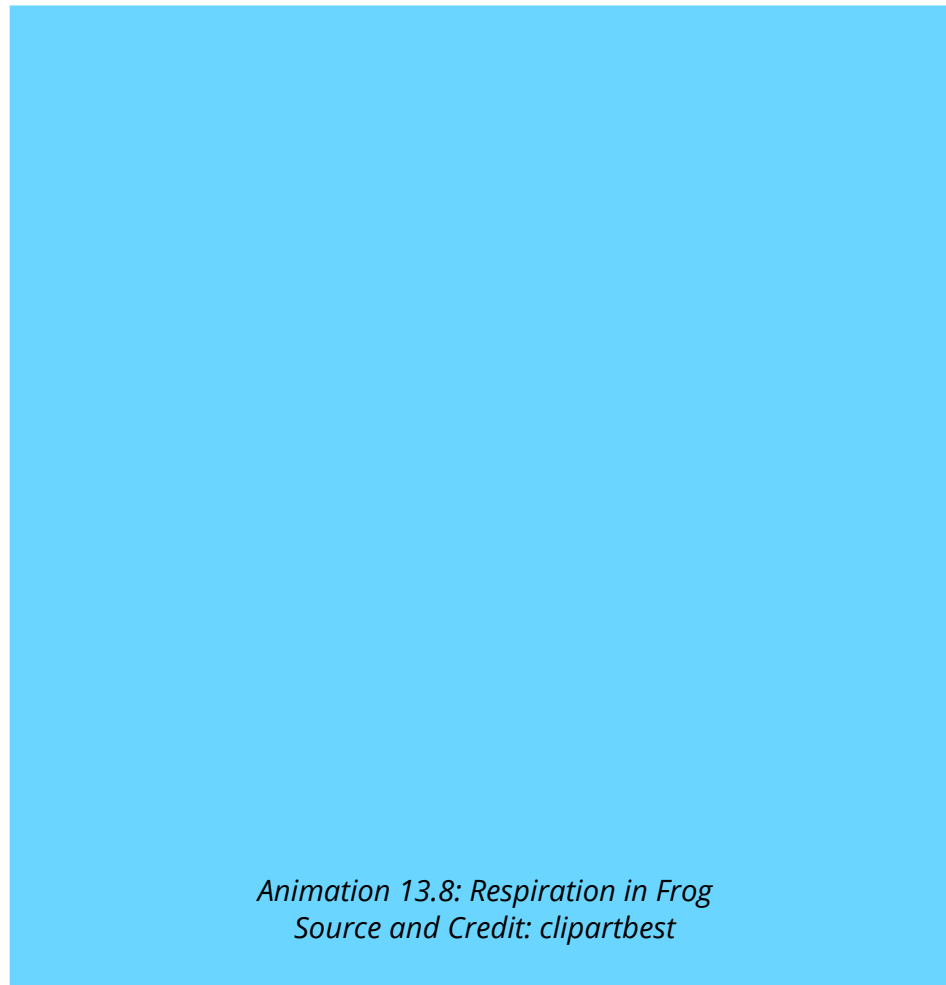

Fig. 13.7 The Respiratory System of Bird



Respiration in man

In man respiratory system includes lungs and air passages which are responsible for carrying fresh air to the respiratory sites.

Air Passage Ways

Air passage ways consist of nostrils, nasal cavities, pharynx, larynx, trachea, bronchi, bronchioles and alveolar ducts which ultimately lead into the alveolar sac. Nasal cavities are lined with mucous membrane of ciliated epithelium. Each nasal cavity is subdivided into three passage ways by the projection of bones from the walls of the internal nose. Air enters the nasal cavity through nostril and the larger dust particles are trapped by the hair and mucus in the nostrils. Air, while passing through the nasal cavity, becomes moist, warm and filtered of smaller foreign particles by mucous

membrane. The nasal cavity leads into the throat or pharynx by two internal openings. The pharynx is a muscular passage lined with mucous membrane. The air is channelized from the pharynx into the larynx.

The **larynx** or voice box is a complex cartilaginous structure surrounding the upper end of the trachea. One of the cartilages, the epiglottis has a muscularly controlled, hinge-like action and serves as a lid which automatically covers the opening of the larynx during the act of swallowing so as to prevent the entry of food or liquids into the larynx. The opening of larynx is called glottis and is also lined with mucous membrane. In the glottis the mucous membrane is stretched across into two thin edged fibrous bands called **vocal cords**, which help in voice production, when vibrated by air.

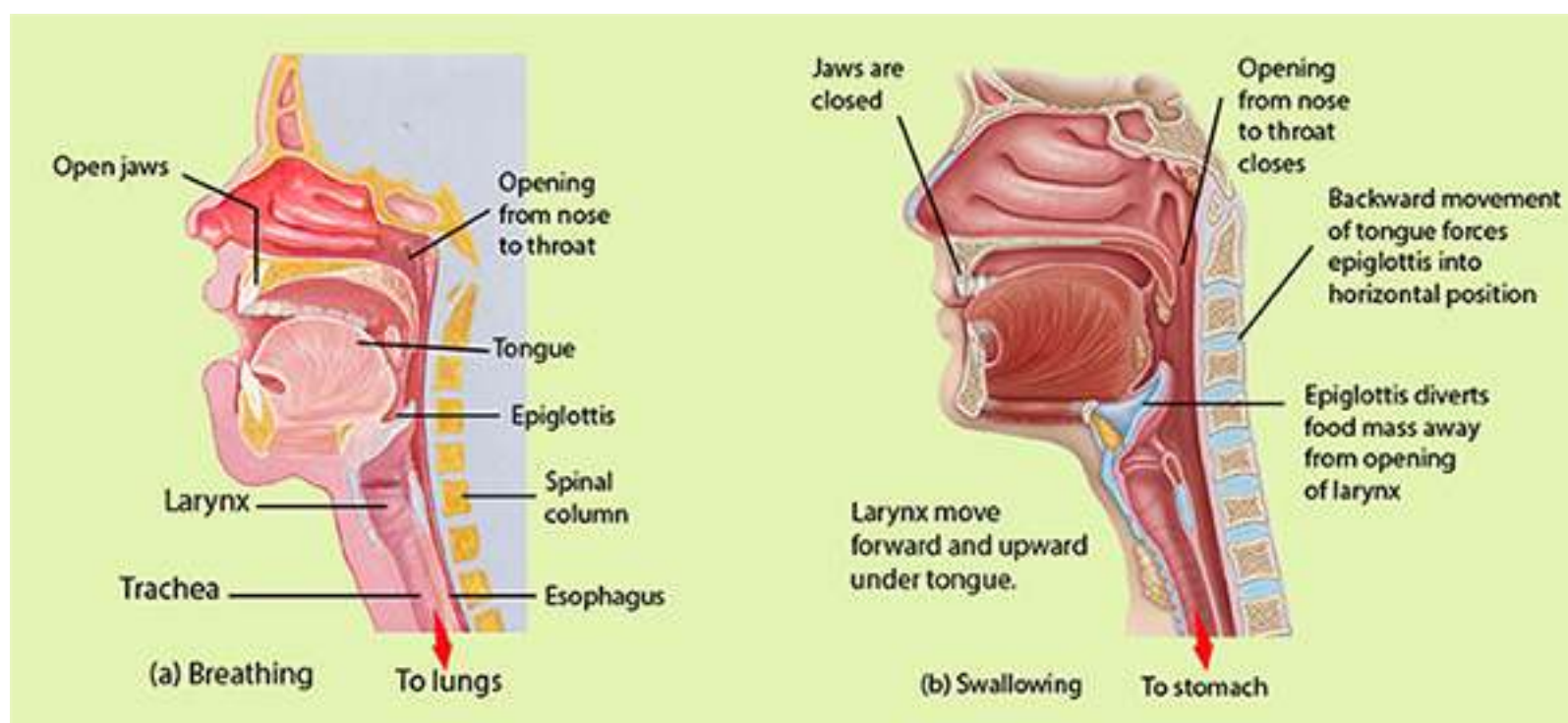

Fig. 13.8 Events in the throat associated with breathing (a) and swallowing (b). The commonly held belief that the epiglottis closes downward upon the larynx when food is swallowed is not quite true. The closure is probably never complete; the degree of closure is determined partly by the backward movement of the tongue during swallowing (which forces the epiglottis into a more or less horizontal position) and partly by the upward movement of the larynx (which brings it up under the epiglottis). Food does not enter the partly open larynx and obstruct breathing primarily because the epiglottis diverts the food mass to one side of the opening and safely down the esophagus.

The **trachea or wind Pipe** is a tubular structure lying ventral to the oesophagus and extends to the chest cavity or thorax where it is divided into right and left bronchi. In the wall of trachea there are a series of C shaped cartilage rings which prevent the trachea from collapsing and keep the passage of air open. Each bronchus on entering the lung divides and subdivides progressively into

smaller and smaller **bronchi**. When the smaller bronchi attain a diameter of one mm or less, then they are called **bronchioles**. Bronchi have the same cartilage rings as the trachea, but the rings are progressively replaced by irregularly distributed cartilage plates and the bronchioles totally lack cartilages. Bronchioles are made up of mainly circular smooth muscles.

The bronchioles continue to divide and subdivide deep into the lungs and finally open into a large number of air-sacs. Air-sac is the functional unit of the lungs. Each air-sac consists of several microscopic single layered structures called **alveoli**. Overlying the alveoli there is a rich network of blood capillaries to produce an excellent site for the exchange of gases.

The lungs are closed sacs that are connected to the outside by way of the trachea and the nostrils or mouth. Lungs are spongy because of the presence of millions of alveoli. Lungs are placed in the chest cavity. Chest cavity is bounded by ribs and muscles on the sides. The floor of the chest is called **diaphragm**. Diaphragm is a sheet of skeletal muscles. Lungs are covered with double layered thin membranous sacs called **pleura (Fig. 13.9)**.

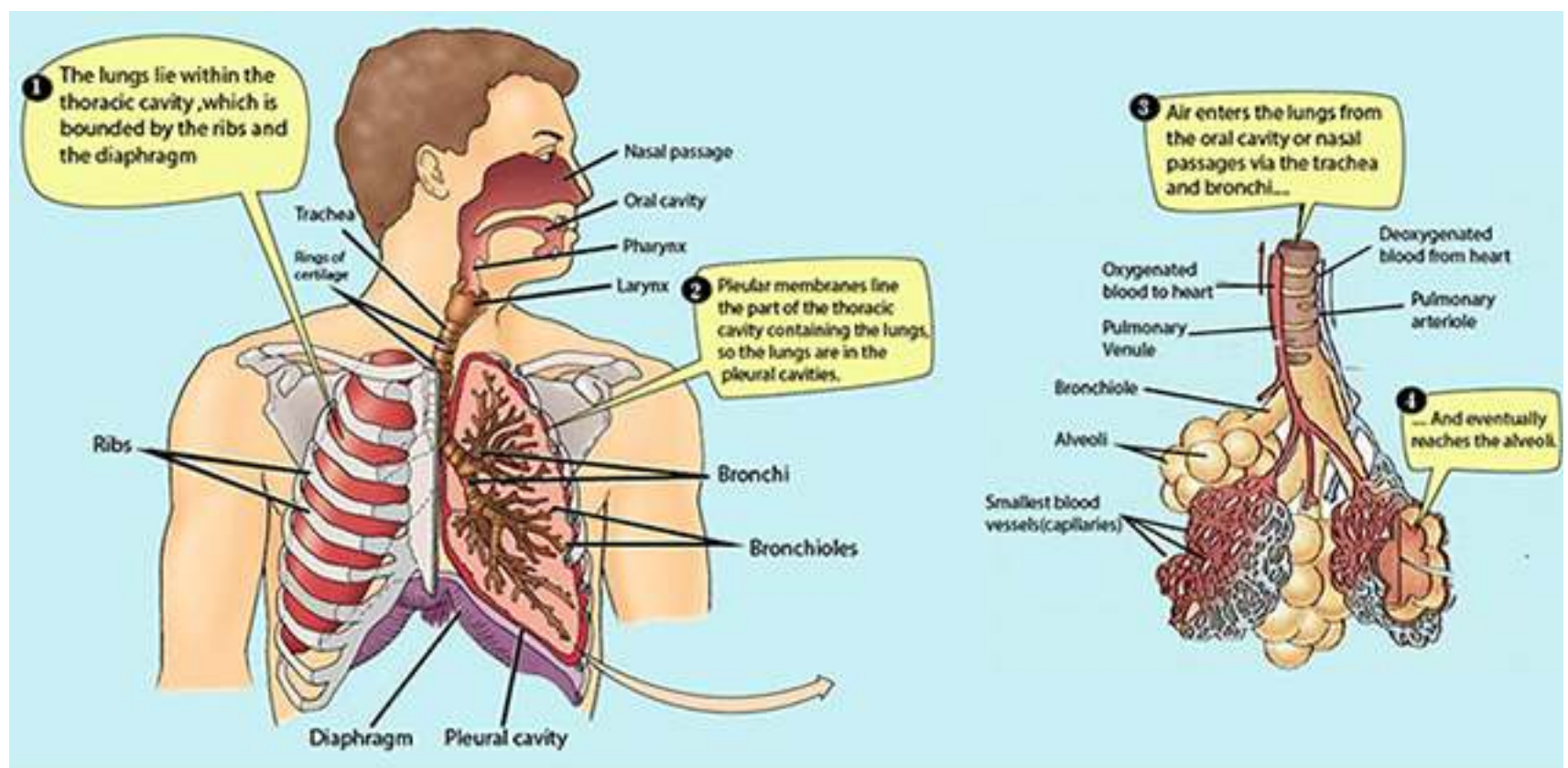

Fig. 13.9 Human respiratory organs



MECHANICS OF VOLUNTARY AND INVOLUNTARY REGULATION OF BREATHING IN MAN

Breathing is a process in which fresh air containing more oxygen is pumped into the lungs and air with more carbon dioxide is pumped out of the lungs. In other words breathing is a mechanical process consisting of two phases, inspiration and expiration. During inspiration, fresh air moves in and in expiration air with low O₂ and high CO₂ content moves out of the lungs. During rest breathing

occurs rhythmically at the frequency of 15 to 20 times per minute in humans. To understand the mechanism of breathing we should keep in mind three aspects related to lungs and associated structures.

1. Lungs are spongy in nature. The lungs themselves neither pull air in nor can they push it out. During inspiration passive expansion of elastic lungs occurs and expiration is due to a passive contraction of lungs.
2. The floor of the chest cavity is diaphragm, which is a muscular sheet. The shape of the diaphragm is more domelike when its muscles are relaxed. On the other hand when the muscles of the diaphragm contract its shape becomes less domelike.
3. Walls of the chest cavity are composed of ribs and intercostal muscles. When muscles between the ribs contract, the ribs are elevated and when muscles between ribs are relaxed the ribs settle down.

Inspiration

During inspiration the space inside the chest cavity is increased in two ways. Firstly, the muscles of ribs contract and elevate the ribs upwards and forwards and secondly, the muscles of diaphragm

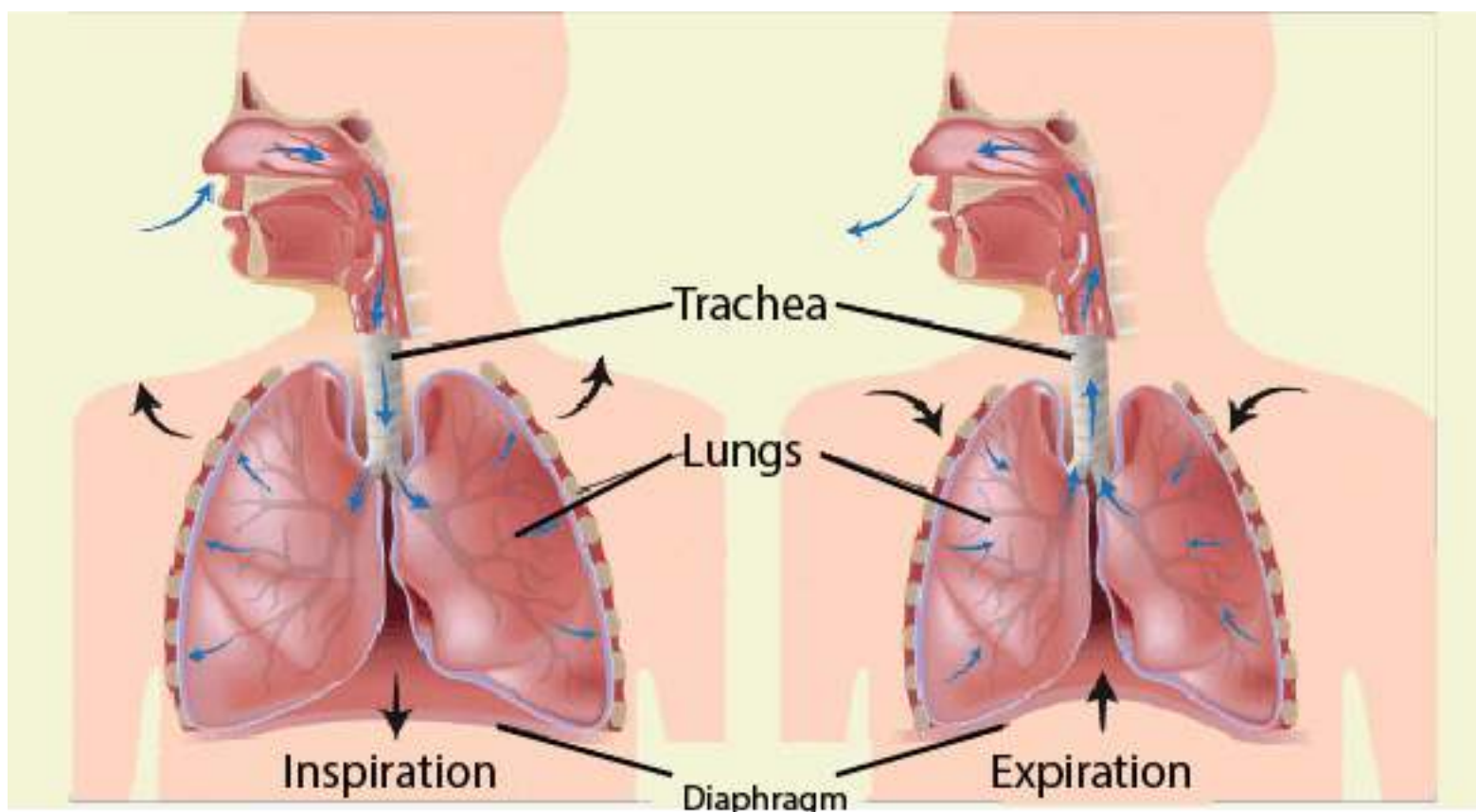

Fig. 13.10 Movement of Diaphragm

also contract and diaphragm becomes less domelike. This downward movement of diaphragm and outward and upward movement of the ribs causes increase in the chest cavity and reduces pressure. When the pressure from the lungs is removed they expand. With the expansion of the lungs vacuum is created inside the lungs in which the air rushes from the outside due to higher atmospheric pressure. This is called inspiration (Fig. 13.10,13.11)

Expiration

During expiration the muscles of ribs are relaxed and the ribs move downward and inward. In this way from the sides of chest cavity the space becomes less. At the same time the muscles of diaphragm also relax becoming more domelike and the chest cavity is also reduced from the floor. This reduction in space of the chest cavity exerts pressure on the lungs. When lungs are pressed the air inside lungs moves out of the lungs and this is expiration. (Fig. 13.10, 13.11)

*In Premature infant, **respiratory distress syndrome** is common, especially for infant with a gestation age of less than 7 months. This occurs because enough surfactant (mixture of lipoprotein molecules produced by the secretory cells of the alveolar epithelium which forms a layer over the surface of the fluid within the alveoli to reduce the surface tension) is not produced to reduce the tendency of the lungs to collapse.*

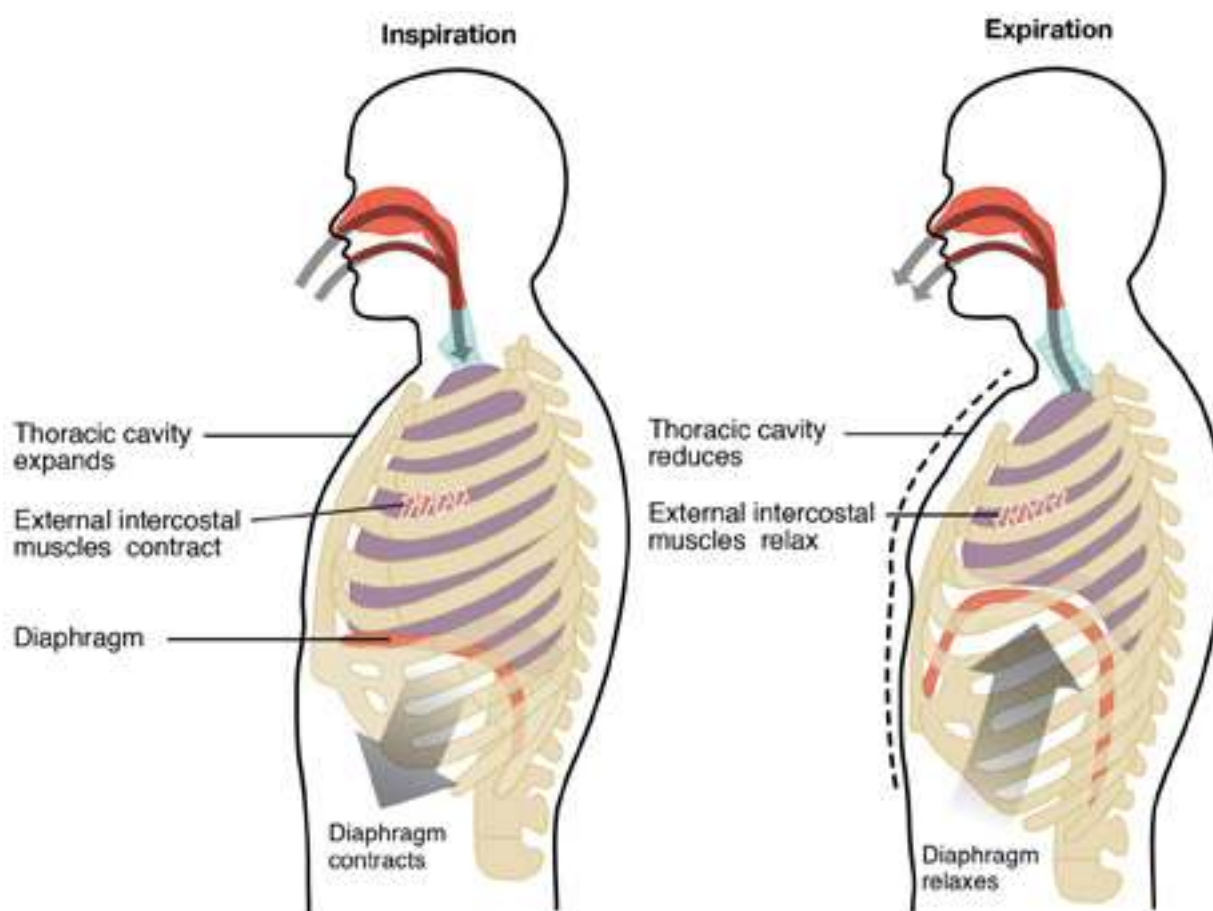

Fig. 13.11

TRANSPORT OF RESPIRATORY GASES

Intake of oxygen and release of carbon dioxide by blood passing through capillaries of alveoli is brought about by the following factors.

1. Diffusion of oxygen in and carbon dioxide out occurs because of difference in partial pressures of these gases.
2. Within the rich network of capillaries surrounding the alveoli, blood is distributed in extremely thin layers and, therefore, exposed to large alveolar surface.
3. Blood in the lungs is separated from the alveolar air by extremely thin membranes of the capillaries and alveoli.

Transport of Oxygen

In human beings the respiratory pigment is haemoglobin. It is contained in the red blood corpuscles. Haemoglobin readily combines with oxygen to form bright red oxyhaemoglobin. Oxyhaemoglobin is unstable and splits into the normal purple-red coloured haemoglobin and oxygen in the conditions of low oxygen concentration and less pressure. Carbonic anhydrase enzyme present in R.B.C. facilitates this activity. In this way haemoglobin acts as an efficient oxygen carrier. A small proportion of oxygen also gets dissolved in the blood plasma.



Haemoglobin can absorb maximum oxygen at the sea level. The maximum amount of oxygen which normal human blood absorbs and carries at the sea-level is about 20ml/100ml of blood. This is the maximum capacity of haemoglobin for oxygen when it is fully oxygenated. Under normal conditions, blood of alveoli of the lungs is not completely oxygenated. When an oxygen tension is 115mm mercury, haemoglobin is 98 percent saturated and, therefore, contains 19.6 ml of oxygen per 100ml of blood. This means that haemoglobin can be almost completely oxygenated by an oxygen pressure of 100 mm mercury, which is present in the lungs. Any higher oxygen pressure would have the same result. When oxygen pressure falls below 60 mm mercury, as in many cells and tissues, the oxygen saturation of haemoglobin decreases very sharply. This results in the liberation

of large quantities of oxygen from haemoglobin. In this way in the tissue where oxygen tension is low oxyhaemoglobin dissociates rapidly.

As a scuba diver descends in the sea, the pressure of the water on his body prevents normal expansion of the lungs. To compensate, the diver breaths pressurized air from air cylinders, which has a greater pressure than sea level air pressure.

There are three important factors which affect the capacity of haemoglobin to combine with oxygen.

1. Carbon dioxide

When carbon dioxide pressure increases, the oxygen tension decreases, the capacity of haemoglobin to hold oxygen becomes less. In this way increased carbon dioxide tension favours the greater liberation of oxygen from the blood to the tissue.

2. Temperature

Rise in temperature also causes a decrease in the oxygen-carrying capacity of blood, e.g., in the increased muscular activity.

3. pH

The pH of blood also influences the degree to which oxygen binds to haemoglobin. As the pH of the blood declines, the amount of oxygen bound to haemoglobin also declines. This occurs because decreased pH results from an increase in hydrogen ions, and the hydrogen ions combine with the protein part of the haemoglobin molecules, causing a decrease in the ability of haemoglobin to bind oxygen. Conversely, an increase in blood pH results in an increased ability of haemoglobin to bind oxygen.

Transport of Carbon Dioxide

Carbon dioxide is more soluble than oxygen and dissolves freely in the tissue fluid surrounding the cells. From the tissue fluid, dissolved carbon dioxide passes to the plasma within the blood capillaries.

Carbon dioxide which is much more important than oxygen as a regulator of normal alveolar ventilation (Breathing) but under certain circumstances a reduced PO_2 (partial pressure of the oxygen) in the arterial blood does play an important stimulatory role especially during conditions of shock.

Carbon dioxide is transported in the blood in several different states.

1. Some of the carbon dioxide (about 20%) is carried as carboxyhaemoglobin. Carboxyhaemoglobin is formed when carbon dioxide combines with amino group of haemoglobin.
2. Other plasma proteins also carry about 5% carbon dioxide from the body fluids to the capillaries of lungs.

3. About 70% carbon dioxide is carried as bicarbonate ion combined with sodium in the plasma. As carbon dioxide from tissue fluid enters the capillaries it combines to form carbonic acid.



The carbonic acid splits quickly and ionizes to produce hydrogen ions and bicarbonate ions.



When blood leaves the capillary bed most of the carbon dioxide is in the form of bicarbonate ions. All these reactions are reversible. In the lungs bicarbonate ions combine with hydrogen ions to form carbonic acid which splits into water and carbon dioxide. It is this carbon dioxide which diffuses out from the capillaries of the lungs into the space of alveolar sac.



4. Small amount of carbon dioxide is also carried by corpuscles combined with potassium.

Carbon Dioxide Concentration in Arterial And Venous Blood

It has been found that arterial blood contains about 50 ml of carbon dioxide per 100 ml of blood whereas venous blood has 54 ml of carbon dioxide per 100 ml of blood. In this way each 100 ml of blood takes up just 4 ml of carbon dioxide as it passes through the tissues and gives off 4 ml of carbon dioxide per 100 ml of blood as it passes through the lungs.

Respiratory Disorders

Cancer

Many problems in the respiratory system can take place if inside lining is exposed continuously to unhealthy air, containing smoke and other pollutants. Lung cancer is one of the most serious diseases of respiratory system. Cancer or carcinoma is basically malignant tumor of potentially unlimited growth that expands locally by invasion and systemically by metastasis. Cancer can occlude respiratory passages as the tumor replaces lung tissue. Smoking especially in young adults is the most potential threat of lung cancer. The chances of lung cancer are ten times more in those

persons who smoke or live in smoky and congested areas as compared to those who do not smoke. It is now estimated that 90% of lung cancer is caused by smoking. Recent research indicates that more than ten compounds of tar of tobacco smoke are involved in causing cancer.

Tuberculosis

Tuberculosis is a disorder of respiratory system. In fact, it is the general name of a group of diseases caused by *Mycobacterium tuberculosis*. Pulmonary tuberculosis is a disease of lungs in which inside of the lung is damaged resulting in cough and fever. It is more common in poor people. Malnutrition and poor living conditions facilitate *Mycobacterium* to grow. The disease is curable with proper medical attention. It is a contagious disease.

Asthma

Asthma is a serious respiratory disease associated with severe paroxysm of difficult breathing, usually followed by a period of complete relief, with recurrence of attack at more or less frequent intervals. It is an allergic reaction to pollen, spores, cold, humidity, pollution etc which manifests itself by spasmodic contraction of small bronchiole tubes. Asthma results in the release of inflammatory chemicals such as histamines into the circulatory system that cause severe contraction of the bronchiole.

Emphysema

Emphysema is a break down of alveoli. This respiratory problem is more common among smokers. The substances present in the smoke of the tobacco weaken the wall of alveoli. The irritant substances of smoke generally cause “smoker’s cough” and coughing bursts some of the weakened alveoli. In the result of constant coughing the absorbing surface of the lung is greatly reduced. The person suffering from emphysema cannot oxygenate his blood properly and least exertion makes him breathless and exhausted.

In patients with emphysema, alveolar walls degenerate and small alveoli combine to form larger alveoli. The result is fewer alveoli, but alveoli with an increased volume and decreased surface area. Although the enlarged alveoli are still ventilated, there is inadequate surface area for complete gas exchange, and the physiological dead air space is increased.

Emphysema produces increased airway resistance because the bronchioles are obstructed as a result of inflammation and because damaged bronchioles collapse during expiration, trapping air within the alveolar sacs.

Role of Respiratory Pigments

Various types of respiratory pigments are present in different animals. The pigment combines with oxygen reversibly and increase the oxygen carrying capacity of the blood. Haemoglobin is the most

important protein present in many animals including man. Haemoglobin in man increases the oxygen carrying capacity of the blood to about 75 times. You are familiar with its chemical composition.

Myoglobin is haemoglobin-like iron-containing protein pigment occurring in muscle fibers. Myoglobin is also known as muscle haemoglobin. It serves as an intermediate compound for the transfer of oxygen from haemoglobin to aerobic metabolic processes of the muscle cells. It can also store some oxygen. Myoglobin consists of just one polypeptide chain associated with an iron-containing ring structure which can bind with one molecule of oxygen. The affinity of myoglobins to combine with oxygen is much higher as compared to haemoglobin.

Diving reflex

Aquatic mammals especially cetaceans can stay in the depth of the ocean for about two hours without coming up for air.

Diving mammals have almost twice the volume of blood in relation to their body weight as compared to non divers. Most of the diving mammals have high concentration of myoglobin in their muscles. Myoglobin binds extra oxygen.

When a mammal dives to its limit the diving reflex is activated. The breathing stops, the rate of heart beat slows down to one tenth of the normal rate, the consumption of oxygen and energy is reduced. The blood is redistributed but most of the blood goes to the brain and heart which can least withstand anoxia. Skin muscles and digestive organs and other internal organs receive very little blood while an animal is submerged because these areas can survive with less oxygen. Muscles shift from aerobic to anaerobic respiration.

Lung capacities

In an adult human being when the lungs are fully inflated the total inside capacity of lungs is about 5 litres. Normally when we are at rest or asleep the exchange is only about half a litre. The volume of air taken inside the lungs and expelled during exercise is about 3.5 litres. In other words, there is a residual volume of 1.5 litres even during exercise which cannot be expelled.

Normally, at rest we inhale and exhale 15-20 times per minute. During exercise the breathing rate may rise to 30 times per minute. The increased rate and depth of breathing during exercise allows more oxygen to dissolve in blood and supplied to the active muscles. The extra carbon dioxide which the muscle puts into the blood is removed by deep and fast breathing. There is a little change in the composition of inhaled and exhaled air during rest or exercise in most of the constituents of the air as seen in the Table 13.1

Table 13.1. Changes in the composition of the breathed air

	Inhaled %	Exhaled %
Oxygen	21	16
Carbon dioxide	0.04	4
Water vapours	variable	saturated
Nitrogen	79	79

EXERCISE

Q.1 Fill in the blanks

- (i) _____ is the most abundant protein in the world.
- (ii) Haemoglobin is a complex molecule which contains 9512 atoms and _____ amino acids.
- (iii) The opening of larynx is called _____.
- (iv) When the smaller bronchi attain the diameter of _____ mm or less they are called bronchioles
- (v) There are about _____ stomata per square centimeter of leaf surface of tobacco plant

Q.2. Write whether the statement is true or false. Correct the statement if it is false.

- (i) ATP is generated during organismic respiration .
- (ii) Water is a better respiratory medium than air.
- (iii) The earthworm does not possess specialized organs for respiration.
- (iv) In parabronchi of birds, the blood flows in the opposite direction of air flow.
- (v) Ring shaped cartilages are present in trachea of man.

Q.3. Short questions

- (i) How does breathing differ from respiration?
- (ii) How much carbon dioxide is present in venous and arterial blood?
- (iii) How does air always remain in the lungs of human beings?
- (iv) What are the products which are produced during photorespiration?

- (v) How much denser is a water medium than air medium for exchange of respiratory gases?

Q.4 Extensive questions

- (i) In what ways is air a better respiratory medium than water?
- (ii) What is photorespiration? Give its consequences.
- (iii) Describe briefly the properties of respiratory surfaces in cockroach.
- (iv) In what ways is respiration in birds the most efficient and elaborate?
- (v) Discuss the mechanical aspects of breathing in man.
- (vi) Write a detailed note on respiratory pigments.
- (vii) List the air passage way in sequence from nostrils to alveoli. Describe the structure of alveolus in detail.

CHAPTER

14

Transport

Animation 14.1: Transport in Plant
Source & Credit: mrgscience

INTRODUCTION

In this chapter our main focus would be to study different processes involved in the transport of nutrients into the cells and removal of the wastes out of the cells. We would also study, essentially in plants and animals, the elaborate mechanism involved not only for the movement of individual molecules but also their mass transport within bodies. The processes involved for getting materials into and out of the cells are diffusion, facilitated diffusion, osmosis, active transport, endocytosis, exocytosis etc.

In animals, the materials move into, within and out of the body, in respiratory circulatory, digestive and excretory systems. In plants the processes of respiration, transportation, photosynthesis, absorption by roots, conduction of water, and the nutrients are involved in movement of the materials into, within and out of the body.

NEED FOR TRANSPORT OF MATERIALS

The living organism is a complex of interactions of physical and chemical reactions involving different elements and molecules. All living cells or living organisms, must obtain and transport certain materials within the body and also transport and remove the wastes out of their bodies or cells.

If there were no transport systems, most of the cells of the body of a complex multicellular organism, would not be able to get the required materials and dispose of their wastes. There are no mass flow systems in unicellular organisms and lower multicellular organisms.

TRANSPORT IN PLANTS

Uptake and Transport of Minerals and Water

The roots of a plant not only anchor the plant body in the soil, but also absorb minerals and water from the soil. There are three types of nutrients needed by the plants, carbon dioxide, water and

A rye plant less than one meter tall has some 14 million branch roots of a combined length of over 600 kilometers.

minerals besides light to carry out photosynthesis. To get these materials, roots must provide large surface area for absorption, which is achieved by extensive branching. The roots bear a dense cluster of tiny hair like structures which are extensions of epidermal cells of roots.

These are the root hairs, which are in fact the sites where most of the uptake of water and minerals takes place.

Plants are able to synthesize all their required compounds, with the help of the minerals and H_2O from soil, CO_2 from air, and light energy. Most of the minerals enter the root hairs or epidermal cells of roots along with water in bulk flow, but some are taken in by diffusion, facilitated diffusion, or active transport.

Mineral absorption by roots

The minerals available to plants for absorption are dissolved in the soil water. Their concentration vary according to the fertility and the acidity of the soil, besides other factors. When the soil minerals are not in solution but are bound by ionic bonds to soil particles, they are not available to plants.

Processes involved in absorption by roots

The uptake of minerals by root cells is a combination of passive uptake and active uptake, involving the use of energy in the form of ATP. The passive uptake involves diffusion. The minerals they also move down their concentration gradient through plasmodesmata (symplast pathway) to cells of cortex, endodermis, pericycle and then to sap in xylem cells. From here they are pulled up by transpiration pull to different parts of plant.

The **diffusion** of ions along with water also takes place by mass flow along the apoplast pathway. Ions moving in the apoplast can only reach the endodermis, where casparian strips prevent further progress (Fig. 14.1). To cross the endodermis, ions must pass by diffusion or active transport into endodermis cells, entering their cytoplasm, and possibly their vacuoles. The ions then reach the xylem cells. Diffusion of ions can also take the vacuolar pathway where the ions move along their concentration gradient through the cell membranes, cytoplasm, and tonoplast (the membrane of vacuoles), and reach the dead xylem cells.

It has been estimated that out of total surface area provided by roots, 67% is provided by the root hairs.

Prosopis trees of leguminosae family have maximum depth of their roots, which is 50 metres.

When inorganic or organic fertilizer is applied to soil, the minerals are absorbed primarily as inorganic ions. The rate of absorption of each mineral by roots is essentially independent of the rates of absorption of water and of the other minerals. Each mineral moves into roots at a rate determined by such factors as its concentration both inside and outside the root, the ease with which it can passively penetrate cell membrane, and extent to which carrier molecules and active absorption are involved.

Most of ions are taken up by the roots by the process of active transport. By this method plants can take a mineral that is in higher concentration inside the root cells than in the soil solution. In this process molecules and ions move from their low concentration to their higher concentration (i.e. against the concentration gradient), through cell membrane, by the use of energy in the form of ATP. Active transport is selective and is dependent on respiration. Some ions move by passive as well as by **active transport**.

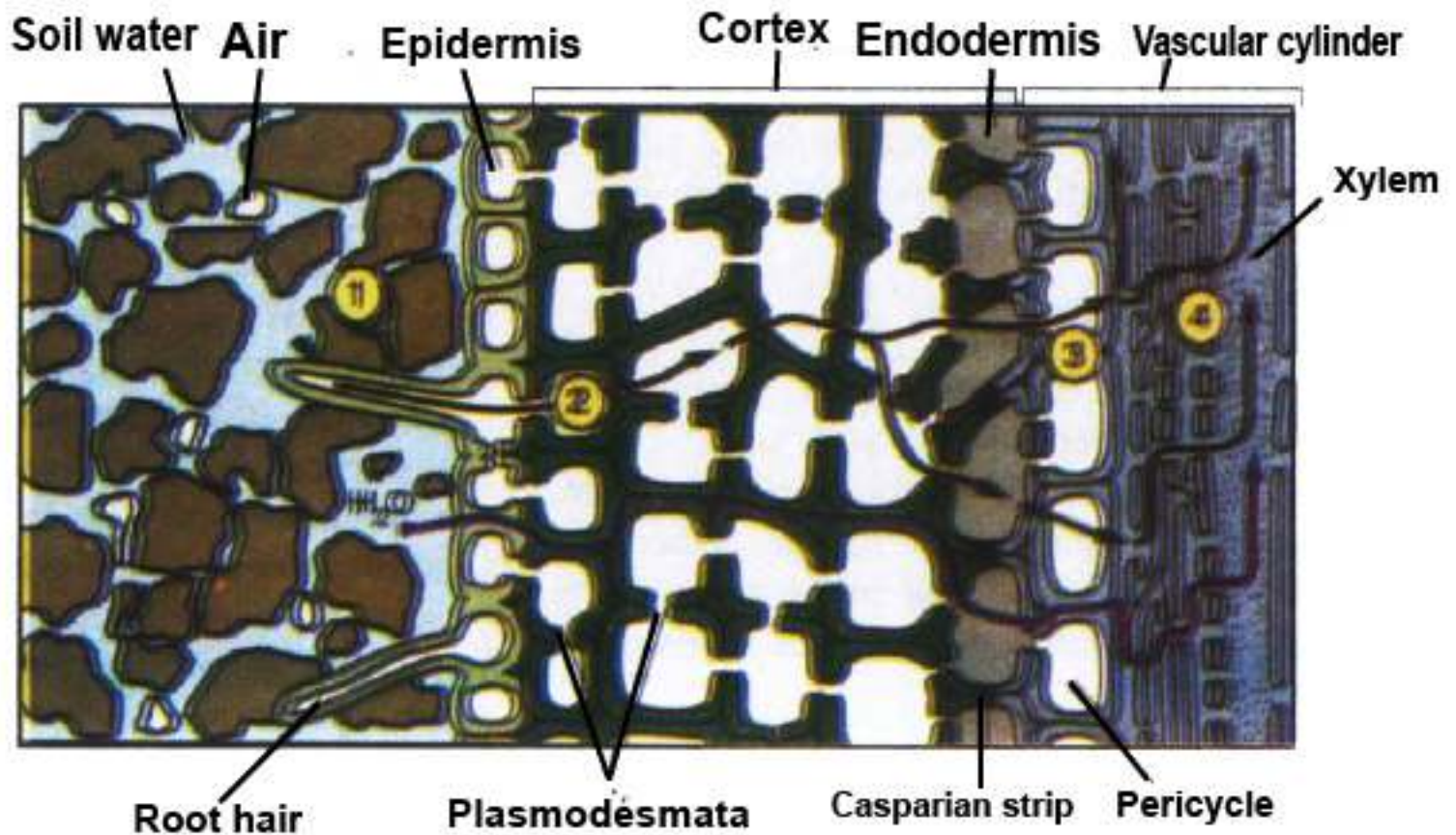
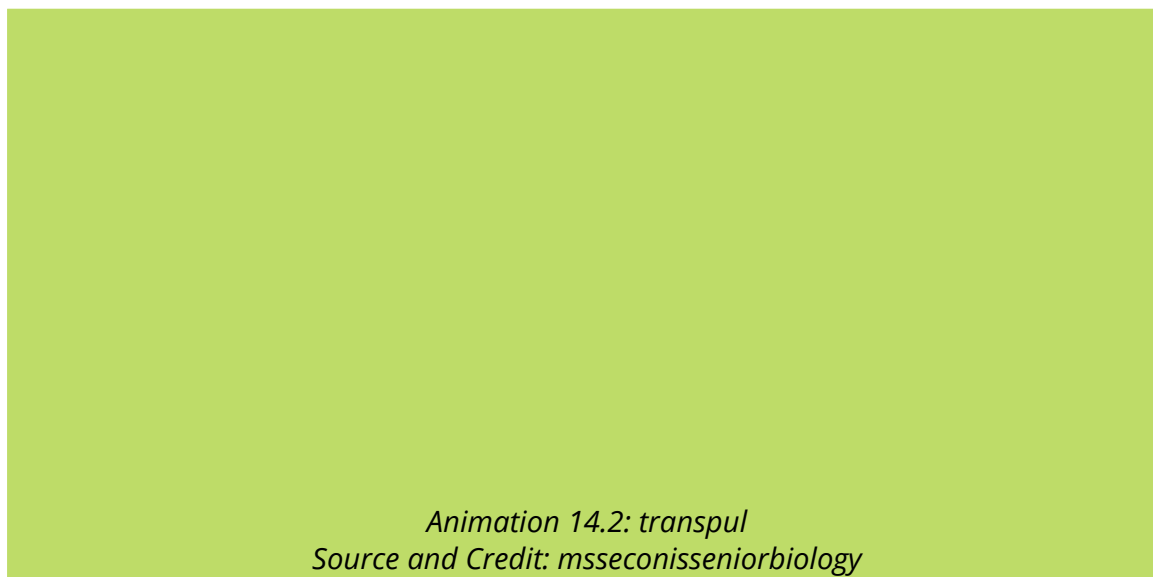

Fig.14.1 Mineral and water uptake by roots. The Casparian strip separates the extracellular space in the root into two compartments: an outer compartment that is continuous with the soil water, and an inner compartment that is continuous with the inside of the conducting cells of the xylem. The black lines show a pathway for both water and mineral; the blue line is an alternative pathway for water alone.



Symbiotic Relationship helps plants acquire nutrients.

One of the important nutrient N_2 is almost always in short supply both in rock particles and in the soil water. Most plants have evolved beneficial relationship with other organisms that help the plants acquire these scarce nutrients. Examples include: Mycorrhizae and nitrogen fixing bacteria in root nodules of legumes.

Mycorrhizae help in uptake of minerals

The fungal associations with roots of higher plants, help mineral uptake by the plant.

The fungi facilitate the uptake of phosphorus and trace metals such as zinc and copper.

A root infected with mycorrhizal fungi can transport phosphate at a higher rate than that of an uninfected root.

Mycorrhizal fungi get sugar, and shelter from the plant and in exchange increase the plant's mineral nutrient uptake efficiency. Mycorrhizae are present in 90% families of flowering plants.

Some nutrients are carried from the soil to the epidermal cells of roots through their cell membrane by **facilitated diffusion**. In this type of diffusion, carrier molecules within the cell membrane transport nutrients across the membrane. These carrier molecules are proteins - which are present within cell membrane of epidermal and other root cells.

Uptake of Water by Roots

Normally, the movement of water molecules from a region of their higher concentration to a region of their low concentration through a partially permeable membrane is called **osmosis**. If water moves by osmosis into a cell the process is called endosmosis, and if the water moves out of the cell it is called exosmosis.

The cell wall of epidermal cells of roots is freely permeable to water and other minerals. The cell membrane, however, is differentially or partially permeable to some substances in the solution. The water which enters the epidermal cells moves along the concentration gradient and passes through cortex, endodermis, pericycle and ultimately to xylem cells. (Fig. 14.2)

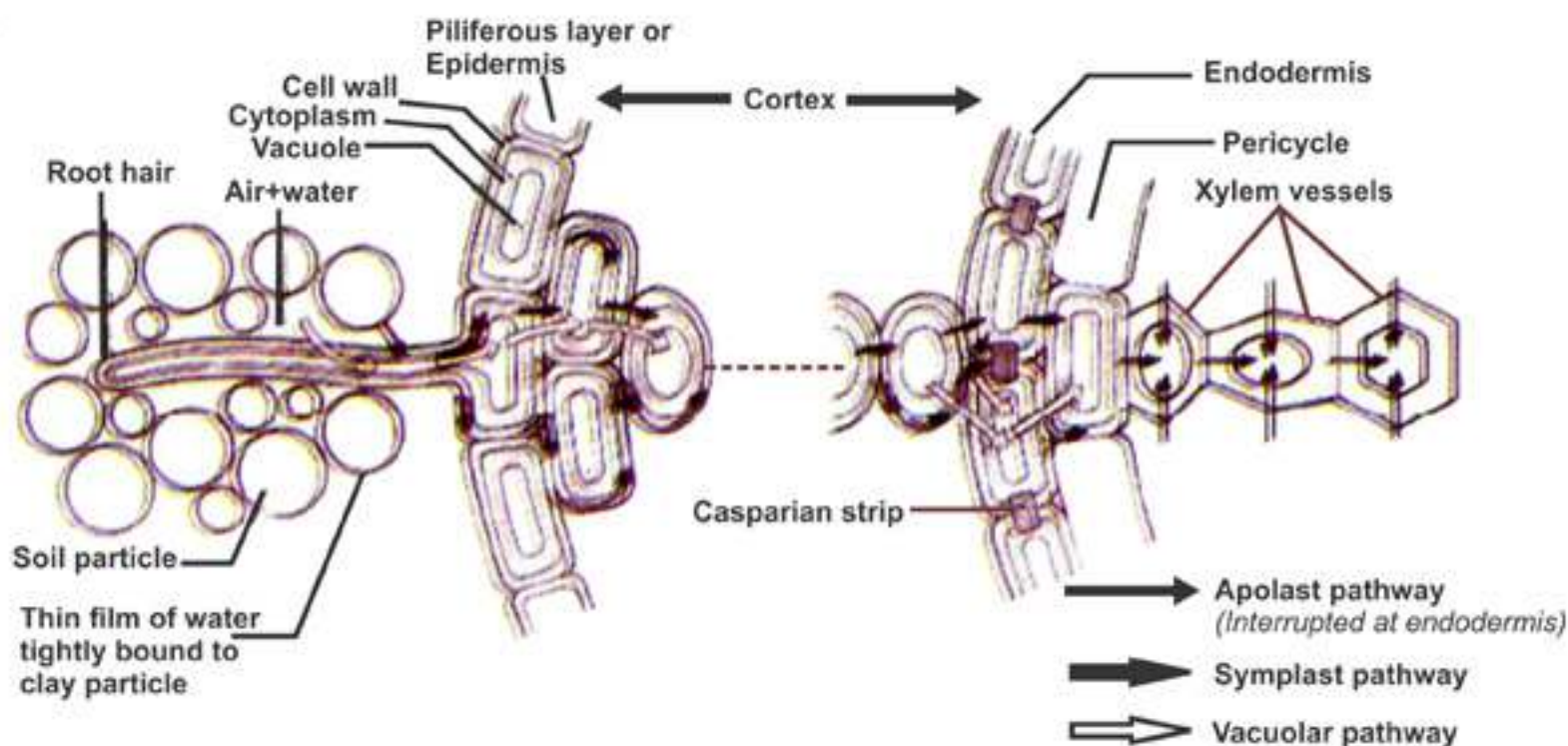

Fig. 14.2 Diagrammatic representation of water and ion movement across a root showing transverse section. The apoplast pathway is of greatest importance for both water and solutes. The symplast pathway is less important, except for salts in the region of the endodermis. Movement along the vacuolar pathway is negligible.

Following are the paths taken by water to reach the xylem tissue:

(i) The apoplast pathway

It is the pathway involving system of adjacent cell walls which is continuous throughout the plant roots. In the roots apoplast pathway becomes discontinuous in the endodermis due to the presence of casparian strips.

(ii) The Symplast pathway

It is the system of interconnected protoplasts in the root cells. The cytoplasm of neighbouring cells (Protoplasts) is connected with one another by Plasmodesmata which are cytoplasmic strands that extend through pores in adjacent cell walls. In the cells of root the cell membrane and cytoplasm (and plasmodesmata) can be regarded as acting together as one partially permeable membrane.

(iii) The vacuolar pathway

In this pathway water moves from vacuole to vacuole through neighbouring cells crossing the symplast and apoplast in the process and moving through cell membranes by osmosis. Water moves passively down a concentration gradient.

Water Potential (Symbolized By Greek Letter Psi = Ψ_w)

Water molecules possess kinetic energy which means that in liquid or gaseous form, they move about rapidly and randomly from one place to another. So, greater the concentration of the water molecules in a system the greater is the total kinetic energy of water molecules. This is called water potential (Ψ_w).

In plant cells two factors determine water potential.

- i) Solute concentration (Osmotic or solute potential = Ψ_s)
- ii) Pressure generated when water enters and inflates plant cells (Pressure potential = Ψ_p).

Pure water has maximum water potential which by definition is zero.

Water moves from a region of higher Ψ_w to lower Ψ_w .

All solutions have lower Ψ_w than pure water and so have negative value of Ψ_w (at atmospheric pressure and at a defined temperature). So **osmosis** can be defined as:

“The movement of water molecules from a region of higher water potential to a region of lower water potential through a partially permeable membrane”.

Osmotic (Solute) Potential = Ψ_s

The osmotic (solute) potential Ψ_s is a measure of the change in water potential (Ψ_s) of a system due to the presence of solute molecules. Ψ_s is always negative. More solute molecules present, lower (more negative) is the Ψ_s .

Pressure Potential (Ψ_p)

If pressure greater than atmospheric pressure is applied to pure water or a solution, its water potential increases. It is equivalent to pumping water from one place to another. Such a situation may arise in living systems.

When water enters plant cells by osmosis pressure may be built up inside the cell making the cell turgid and increasing the pressure potential. Thus the total water potential is sum of Ψ_s and Ψ_p .

$$\begin{array}{ccccccc} \Psi_w & = & \Psi_s & + & \Psi_p \\ \text{water potential} & & \text{solute potential} & & \text{pressure potential} \end{array}$$

If we use the term water potential, the tendency for water to move between any two systems can be measured; not just from cell to cell in a plant but also from soil to root from leaf to air or from soil to air. The steeper the potential gradient the faster is the flow of water along it.

The following example would help understand the concept of water potential. Two adjacent vacuolated cells are shown with ψ_w , ψ_p and ψ_s .

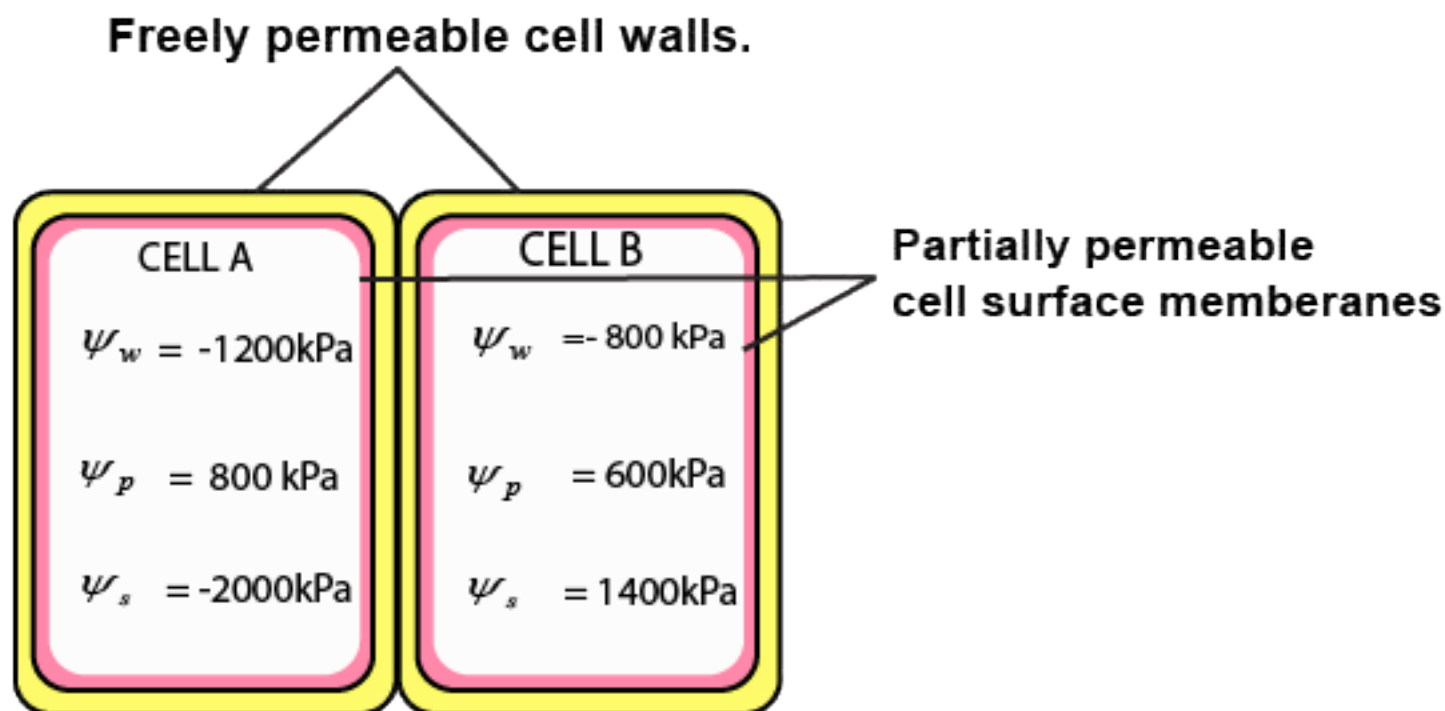

Fig. 14.3 Two adjacent vacuolated cells.

- Q. a) Which cell has the higher water potential?
 b) In which direction will water move by osmosis?
 c) What will be the water potential of the cells at equilibrium?
 d) What will be the solute potential and pressure potential of the cells at equilibrium?

kPa = 1000 Pascals - which is the pressure exerted by a vertical force of one Newton on an area of 1 metre square.

Plasmolysis and Pressure Potential

Plasmolysis can be defined as the shrinkage of protoplast due to exosmosis of water. When a living cell is placed in a solution having lower water potential than that of the cell, plasmolysis takes place and the cell is called plasmolysed. If this plasmolysed cell is placed in distilled water (which has highest water potential) the water molecules would move from distilled water through differentially permeable cell membrane into the cell, and the cell would become deplasmolysed.

The point at which plasmolysis is just about to happen is called **incipient plasmolysis**. At incipient plasmolysis the protoplast has just ceased to exert any pressure against the cell wall, so the cell is flaccid.

If a plasmolysed cell is placed in distilled water, the one having higher water potential than the contents of the cell, water enters the cell by endosmosis, volume of protoplast increases, and it begins to exert pressure against the cell wall of plant cell. The cell wall is rigid - so the pressure exerted by the protoplast against the cell wall is called **pressure potential**. As the pressure potential of the cell increases due to endosmosis, the cell becomes turgid. Full turgidity i.e. maximum pressure potential is achieved when a cell is placed in pure water or distilled water.

The animal cells cannot withstand higher pressure potential as there is no cell wall around protoplast. Thus the turgid cells burst in a solution of higher water potential. So the animals employ the mechanism of osmoregulation to maintain the amount of water and salts in their cells to constant or nearly constant levels.

ASCENT OF SAP

In the previous pages you have learned that water and dissolved minerals traverse the cortex and endodermis and reach the xylem tissue of roots. (Fig. 14.1,14.2) Actually, water and dissolved minerals are carried or pulled upwards towards the leaves through xylem tissue. This is called ascent of sap. This may involve the following :

(A) Cohesion Tension Theory (B) Root Pressure (C) Imbibition

(A) Cohesion tension theory is one of the most important theories proposed by Dixon. This theory provides a reasonable explanation of flow of water and minerals upwards from the roots to leaves of plants, in bulk flow or mass flow (Fig. 14.5). This depends on the following:

(i) Cohesion: It is the attraction among water molecules which hold water together, forming a solid chain-like column within the xylem tubes. The water molecules form hydrogen bonds between them.

(ii) Tension: It is provided when this water chain is pulled up in the xylem (Fig. 14.4). Transpiration

provides the necessary energy or force. Tension is between the molecules of water by hydrogen bonds.

This xylem water tension is strong enough to pull water up to 200 metres (more than 600 feet) in plants.

(iii) Adhesion: It may be added that the water molecules also adhere to the cell walls of xylem cells, so that the column of water in xylem tissue does not break. The composition of cell wall provides necessary adhesion to water molecules that helps water creep up. The cellulose component of cell wall especially has great affinity for water. It can imbibe water.

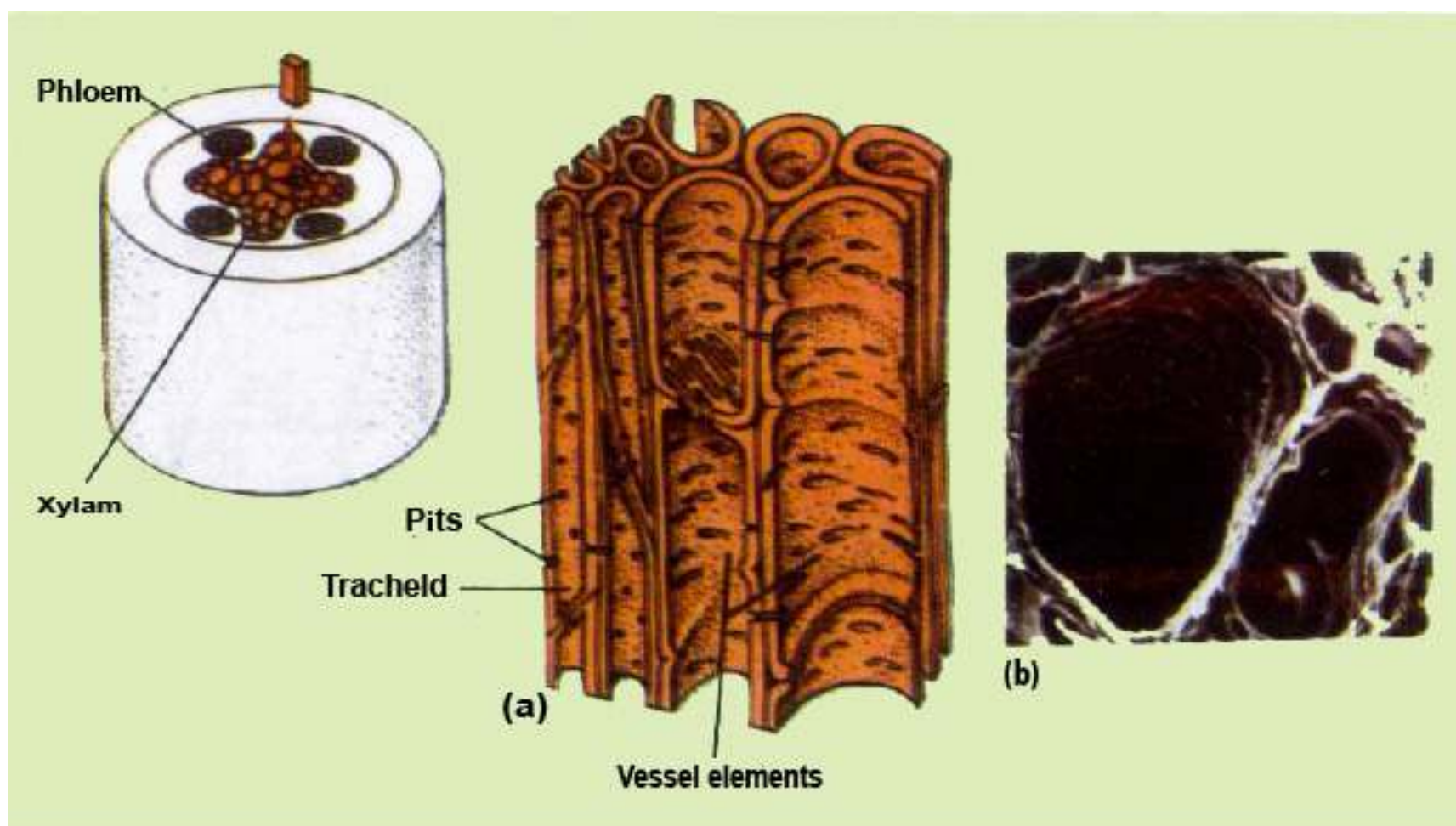

Fig.14.4 (a) Xylem Tissue elements involved in transportation of water and dissolved minerals, (b) Scanning electron micrograph of two large vessel elements of a cucumber root.

(iv) Strong xylem walls: It is essential that the xylem walls should have high tensile strength if they are not to buckle inwards. The lignin and cellulose provides strength to cell wall of xylem vessels (Fig. 14.4).

By cohesion-tension of water molecules, and the transpiration pull providing the necessary energy, the sap (water and minerals) in xylem tissue is pulled upwards to the leaves. Large quantities of water are carried at relatively high speed, upto 8mh^{-1} being recorded in tall trees, and commonly in other plants at 1mh^{-1} .

The total water pulled up in the leaves is transpired, except about 1% which is used by plant in various activities including photosynthesis.

Mechanism of transpiration pull in cohesion tension theory

The evaporation of water from the aerial parts of the plant especially through stomata of leaves is a process called **transpiration**. As a leaf transpires the water potential of its mesophyll cells drops. This drop, causes water to move by osmosis from the xylem cells of leaf into dehydrating mesophyll cells. The water molecules leaving the xylem are attached to other water molecules in the same xylem tube by hydrogen bonds (cohesion of water molecules). Therefore, when one water molecule moves up the xylem, the process continues all the way to the root - where water is pulled from the xylem cells (tracheids and vessels). This pull also causes water to move down its concentration gradient transversely from the root epidermis (root hairs) to cortex by endosmosis and to pericycle. This pulling force or transpiration pull is so strong that it also reduces the water potential of root epidermal cells. Then water in the soil moves from its higher water potential to lower water potential of epidermis of root by osmosis.

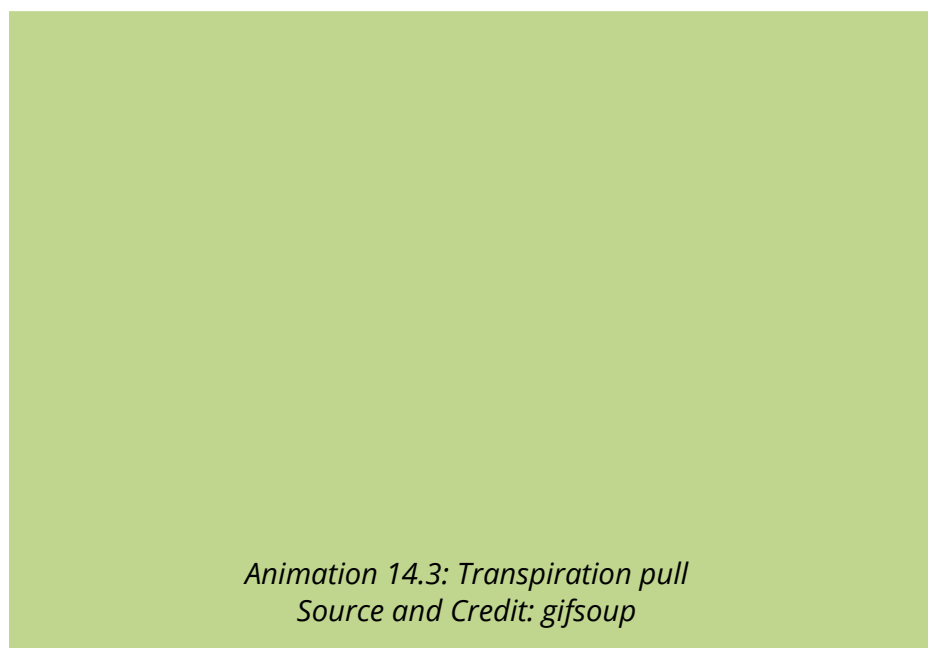

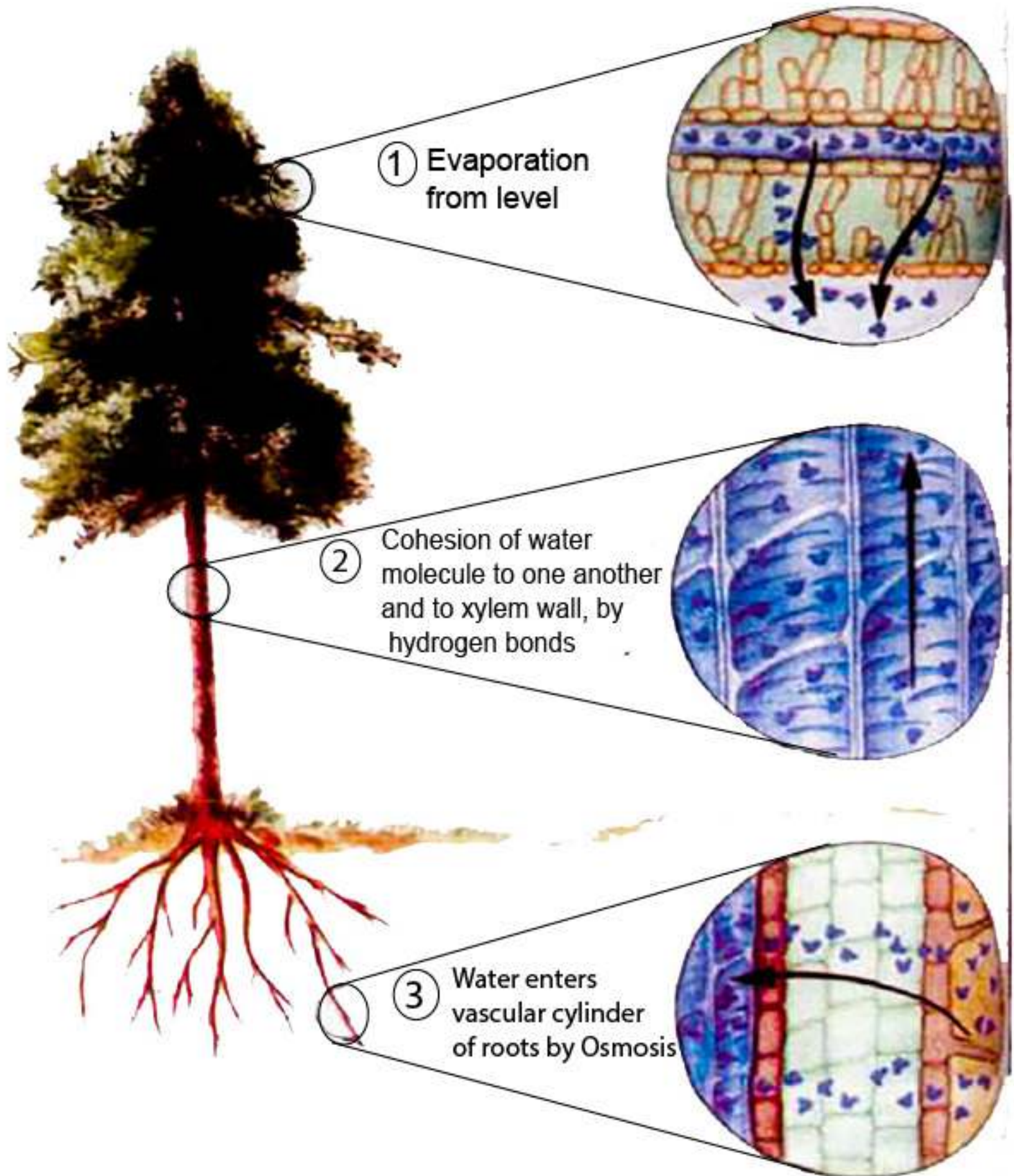

Fig.14.5 The cohesion-tension theory of water flow from root to leaf.

(B) Root pressure : Second force involved in the movement of water and dissolved minerals up in the xylem tissue is the root pressure. Root pressure is created by the active secretion of salts and other solutes from the other cells into the xylem sap. This lowers the water potential of xylem sap. Water enters the xylem cells by osmosis, thus increasing the level of sap in the xylem cells. Water entering the xylem cells, may take apoplast, symplast or vacuolar pathway increasing the hydrostatic pressure in cells, this pushes the water upwards. As a result of root pressure the sap in the xylem does not rise to enough height in most plants. The root pressure is also least effective during the day, when transpiration pull is the active force involved in pulling the sap in xylem cells upwards. It has been estimated that a positive hydrostatic pressure of around 100 to 200 KPa (exceptionally 800 KPa) is generated by root pressure. The pressure mentioned above is not enough to push water upwards to required height in most plants. But it is no doubt a contributing factor in plants which transpire slowly, and are smaller in size.

Closely associated with root pressure is a phenomenon called guttation or exudation. Guttation is loss of liquid water through water secreting glands or hydathodes. The dew drops that can be seen on the tips of grass leaves or strawberry leaves are actually guttation droplets exuded from hydathodes. (Fig. 14.6).

Guttation or exudation is more notable when transpiration is suppressed, and the relative humidity is high as at night. The guttation is in fact due to positive pressure - the root pressure, developed in xylem tissue of roots.



Fig. 14.6 Guttation by strawberry leaves

(C) Imbibition : Another important force in the ascent of sap is imbibition. Sacks in 1874 suggested that the water molecules move along the cell walls of xylem vessels due to imbibition.

The cell wall components especially cellulose, pectin and lignin can take up water and as a result

increase in volume, but the components do not dissolve in water, this is called imbibition. The amount of attraction and increase of dry cell walls of plant cells, and of protoplasm for water is often very great and considerable imbibition forces may be developed in plant body. The root cell walls imbibe water from the soil, and this water moves by apoplast pathway already discussed.

Imbibition is a reversible process and when water is lost the original volume of cell wall and of protoplasm is restored. The uptake of water by imbibition is especially important in germinating seeds. The volume of dry seed may increase up to 200 times by imbibition, as a result, the seed coat ruptures and makes the germination of seed effective.

Bleeding : Sometimes it so happens that certain plants, when cut, pruned, tapped or otherwise wounded, show a flow of sap from the cut ends or surfaces quite often with a considerable force. This phenomenon is commonly called **bleeding**.

It is often seen in many land plants in the spring, particularly grape vine, some palms, sugar maple etc.

Although the flow of sap is ordinarily slow, a considerable quantity of the sap within a period of 24 hours comes out of the plant. In some palms when tapped, there may be a flow of sap to the extent of 10-15 litres per day. The sap in such plants contains sugars and water in addition to organic and inorganic substances (e.g. salts).

There are two main factors responsible for bleeding, the hydrostatic pressure in xylem and phloem elements, and the root pressure, which is exerted by the xylem tissues of roots.

TYPES OF TRANSPIRATION

You have already studied the role of transpiration, in ascent of sap.

There are three types of transpiration depending upon the route of escape of water vapours from the aerial parts of the plant.

- (i) Cuticular transpiration (ii) Lenticular transpiration (iii) Stomatal transpiration

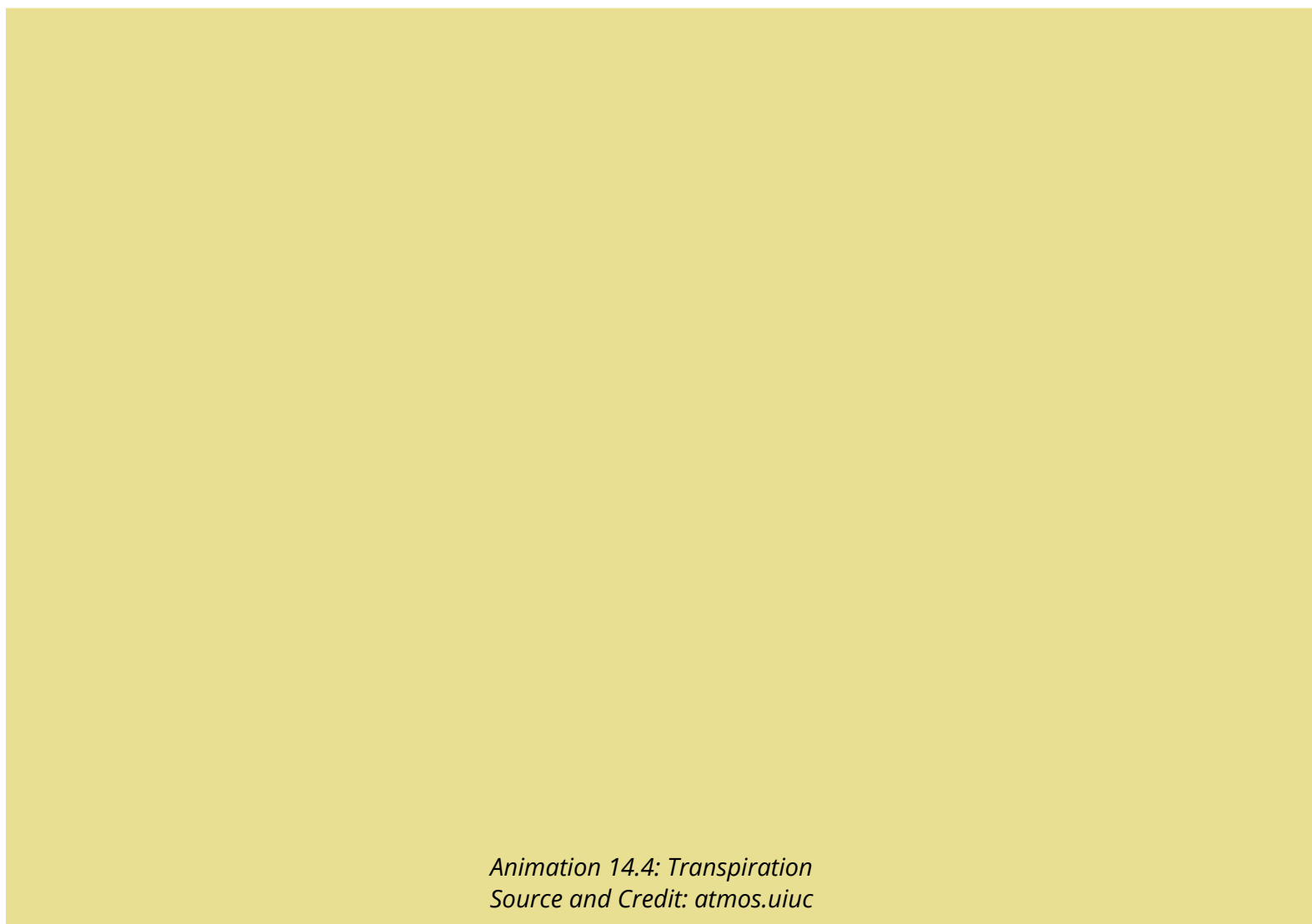

(i) Cuticular transpiration : The loss of water in the form of water vapours through the cuticle of leaves is called cuticular transpiration. About 5-7% of total transpiration takes place through this route.

The cuticle present on the upper and lower epidermis of leaves is not completely impermeable to water and some water is lost in the form of vapours through cuticle. The thinner the cuticle the greater is the rate of transpiration; although the composition of cuticle is also important. At night, when the stomata are almost closed, cuticular transpiration takes place. Most of the factors which affect rate of transpiration, in general, are also important in controlling the rate of cuticular transpiration.

(ii) Lenticular transpiration : Lenticular transpiration is the loss of water vapours through lenticels present in the stem of some plants. (Fig. 14.7) All plants do not possess lenticels.

The lenticular transpiration is 1-2% of the total transpiration by a plant. These openings, like stomata, are also involved in the exchange of gases between environment. When there is strong light and high temperature, the loss of vapours is rapid because it is governed by diffusion.

Lenticels are aerating pores formed in the bark through which exchange of gases takes place, and water is lost in the form of water vapours (transpiration). Externally, they appear as scars or small protrusions on the surface of stem. Lenticel consists of a loose mass of small, thin-walled cells. At each lenticel the cork cambium forms oval, spherical, or irregular cells, which are very loosely arranged, having lots of intercellular spaces.

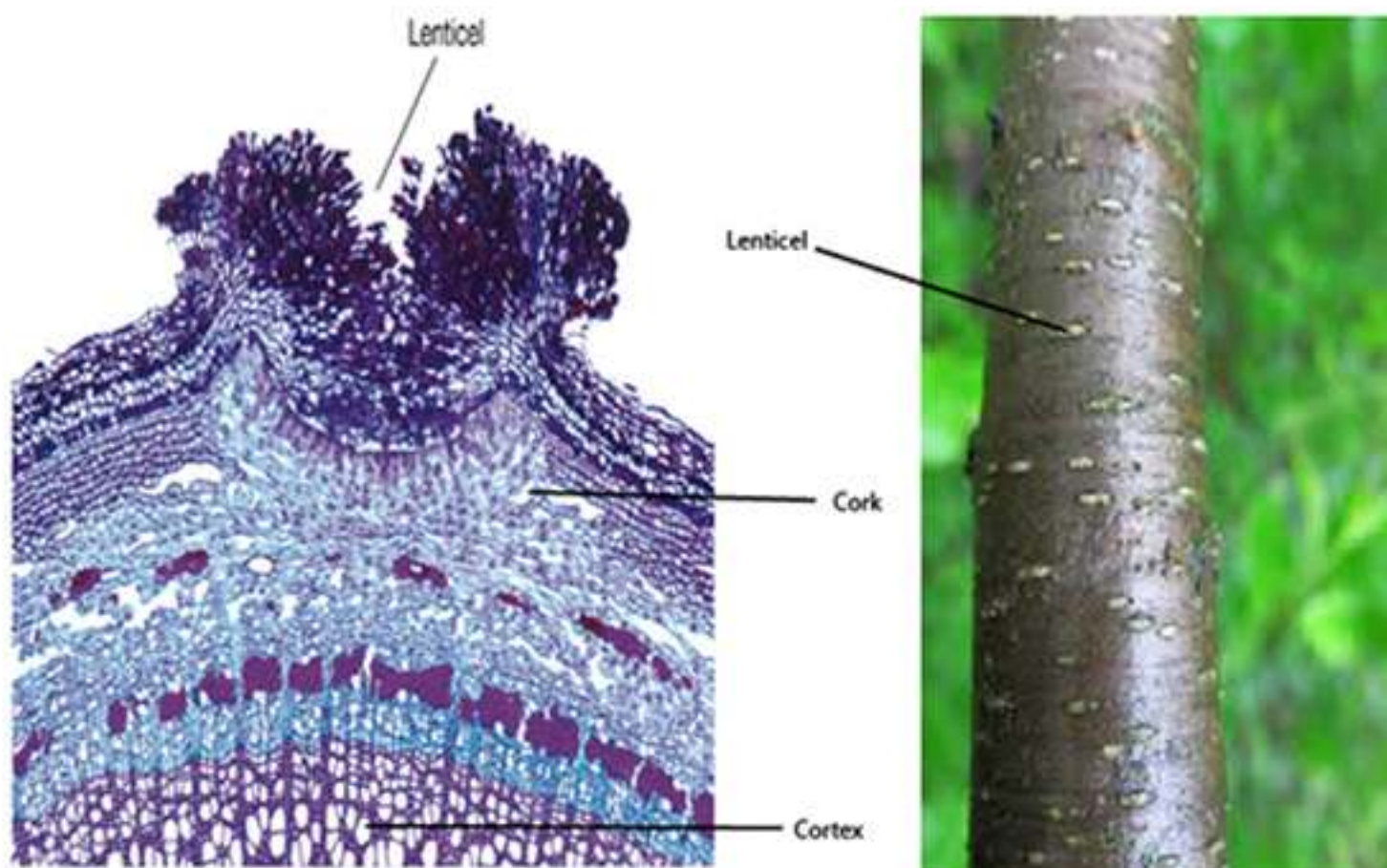

Fig. 14.7 Left : The waterproof outer bark (layer of dark cells on the surface) on this section of stem is interrupted at the center of the lenticel. Thus the more loosely arranged cell layer beneath, with their numerous intercellular air spaces, are exposed to the atmosphere, Right: The individual lenticels can be seen as white areas on the surface of a young stem.

(iii) Stomatal transpiration : It is a type of transpiration in which the water vapours escape through stomata. In isobilateral leaves the stomata are present, in both, upper and lower epidermis e.g. lily and maize leaf. In dorsiventral leaves the stomata are confined to only the lower epidermis.

The guard cells are normally dumbbell or bean-seed-shaped. The inner concave sides of two guard cells enclose the stoma. This inner side of guard cell has very thick cell wall, but the outer convex

side has thin cell wall. The guard cells are the only cells, of leaf epidermis, which are not connected by plasmodesmata to other epidermal cells, and which have chloroplasts - and thus are involved in the process of photosynthesis (Fig. 14.8). When these guard cells are turgid, the stoma between them opens and when the guard cells are flaccid the stoma between them closes. The degree of opening of stomatal pores also affects the rate of transpiration. 90% of total transpiration in a plant is stomatal.

The cells of mesophyll of leaf provide enormous surface 'area for the loss of water in the form of vapours. The pathway of water vapours loss to the atmosphere, through stomata is shown. (Fig. 14.8)

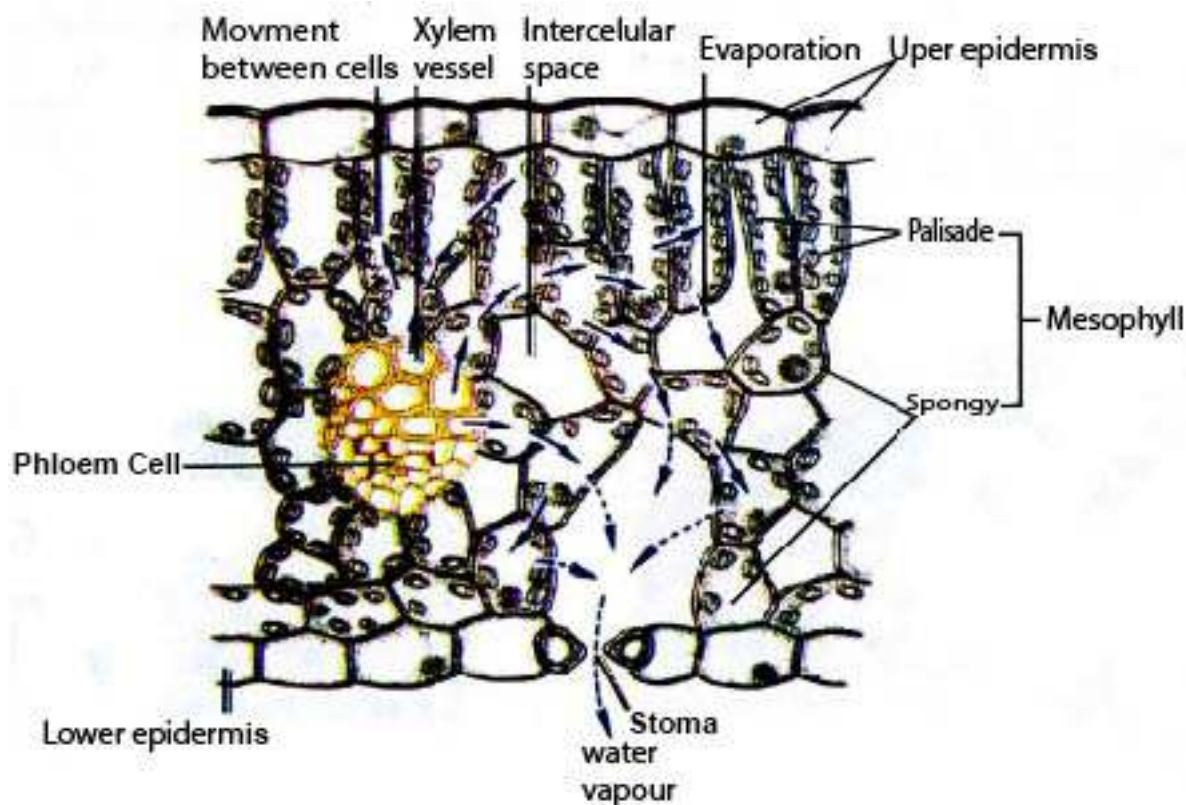

Fig.14.8 The water pathway through the leaf. Water is drawn from the xylem into the cell walls of the mesophyll, where it evaporates into the air spaces within the leaf. By diffusion, water vapour then moves through the leaf air space, through the stomatal pore, and across the boundary layer of still air that adheres to the outer leaf surface. CO_2 also diffuses into the leaf through stomata along a concentration gradient.

OPENING AND CLOSING OF STOMATA

The guard cells function as multisensory hydraulic valves (Fig. 14.9). Environmental factors, such as light intensity and quality, temperature, relative humidity, and intracellular CO_2 concentration are

sensed by guard cells and these signals are integrated into well-defined stomatal responses.

There are two hypotheses which may explain the opening and closing of stomata.

i) Starch Sugar Hypothesis : The German botanist H. Van Mohl proposed that the guard cells are the only photosynthesising cells of epidermis of leaf and sugars are produced in them during day time when light is available. When sugar level rises i.e. solute concentration increases or water potential decreases - and the guard cells become turgid due to entry of water and they separate from one another, and stoma or pore opens. During night there is no photosynthesis the sugars are either converted into insoluble starch or are used in respiration, this decreases free sugars in cell. So the osmotic pressure of guard cells is lowered, and water leaves the guard cells, which become flaccid and stoma or pore between them closes. But these processes are not fast enough to account for the rapid rise in turgor, of guard cells.

ii) Influx of K^+ ions : Potassium concentration in guard cells increases several fold, depending upon plant species.

Stomata open due to active transport of potassium ions (K^+) into the guard cells from the surrounding epidermis. The accumulation of K^+ decreases the osmotic potential of guard cells. Water enters the guard cells by osmosis, which become more turgid and stretched and stomata are opened. The stoma closes by reverse process; involving passive diffusion of K^+ from guard cells followed by water moving out by osmosis. What controls the movement of K^+ into and out of guard cells? Level of carbon dioxide in the spaces inside the leaf and light, control this movement. A low level of carbon dioxide favours opening of the stomata, thus allowing an increased carbon dioxide level and increased rate of photosynthesis.

Exposure to blue light, which is also effective in photosynthesis has been shown to acidify the environment of the guard cells (i.e. pumps out protons) which enable the guard cells to take up K^+ followed by water uptake resulting in increased turgidity of guard cells. So in general stoma are open during day and closed at night. This prevents needless loss of water by the plant when it is too dark for photosynthesis.

The plants open their stomata by actively pumping Potassium in guard cells causing water to follow by osmosis. Guard cells become turgid and stoma or pore opens. When Potassium leaves the guard cells (during night) water leaves the guard cells by exosmosis and guard cells become flaccid and stoma or pore between guard cells closes.

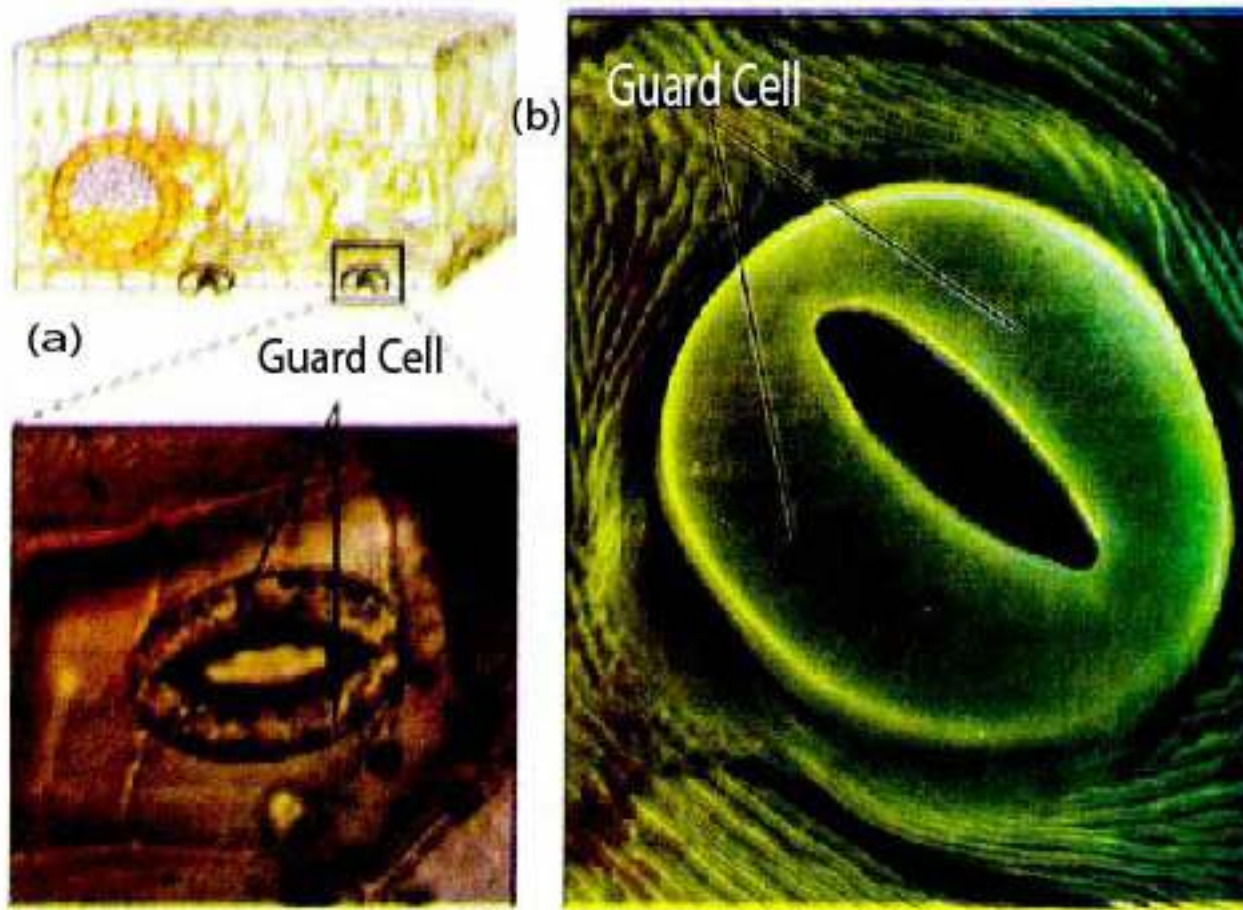
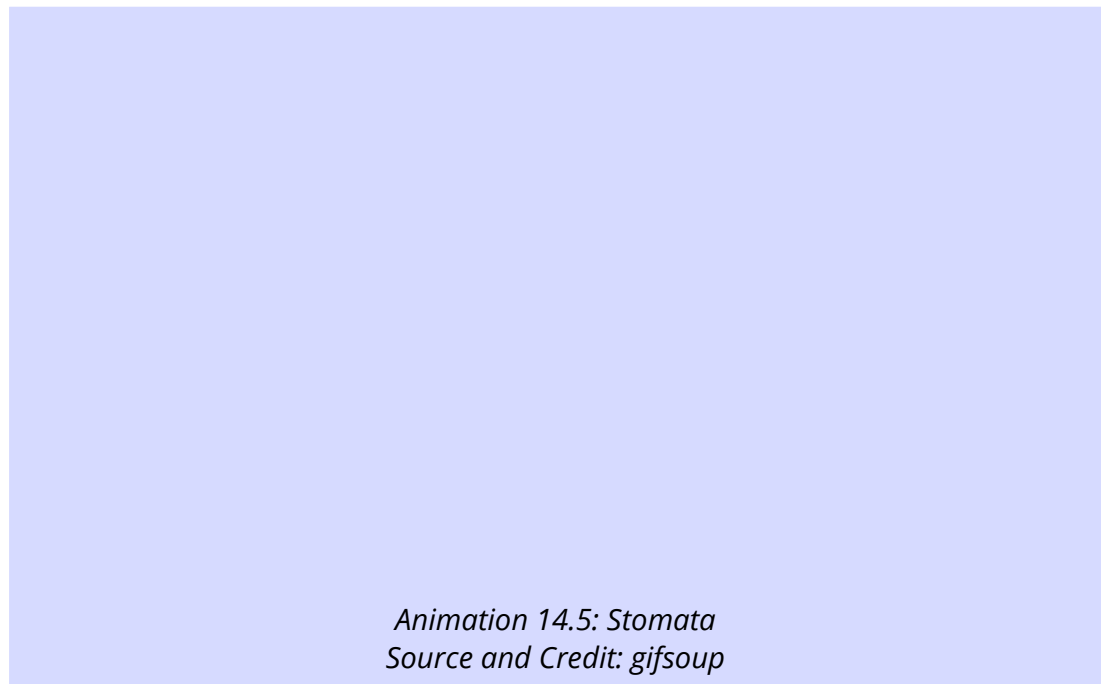

Fig 14.9 Stomata . Stomata seen through (a) the light microscope and (b) scanning electron microscope. In the light micrograph, note that the guard cells contain chloroplasts (the green ovals within the cells) but that the other epidermal cells do not.



Factors affecting the rate of transpiration

Rate of transpiration for a plant is very important as the transpiration stream is necessary to

distribute dissolved mineral salts throughout the plant. Water is transported to photosynthesizing cells of leaves. Transpiration is also very important as it cools the plant. This is especially important in higher temperatures. If the rate of transpiration is very high, there would be much loss of water from the plant, so at high temperatures the stomata almost close and reduction in the rate of transpiration is effected. This stops wilting of the leaves and of plants (herbaceous plants).

There are some important factors which affect the rate of transpiration in a plant.

- | | |
|-------------------------------------|-----------------------------------|
| (i) Light | (ii) Temperature |
| (iii) CO ₂ concentration | (iv) Humidity and vapour pressure |
| (v) Wind and | (vi) Availability of soil water. |

i) Light : The opening and closing of stomata is directly controlled by the light. In strong light the rate of transpiration is much more as compared with that in dim light or no light. As Potassium actively enters the guard cells, when light is available, water follows - and guard cells become turgid, and stoma opens.

ii) Temperature: When the sun-light is strong on a bright and sunny day the environmental temperature is increased. The higher temperature reduces the humidity of the surrounding air. The evaporation of water from the surfaces of mesophyll cells also increases, thus increasing the rate of transpiration.

The rate of transpiration doubles by every rise of 10°C in temperature. Very high environmental temperature, i.e. 40-45°C cause closure of stomata, so that plant does not loose much needed water. If higher temperatures are maintained in the environment for a longer duration and soil water is limited, the plants would wilt and may die.

Hormones are involved in stomatal movement in plants. At high temperature when leaf cells start wilting a hormone is released by mesophyll cells. This hormone is called abscisic acid. This hormone stops the active transport of K⁺ into guard cells, overriding the effect of light and CO₂ concentration. So K⁺ pumping stops. Stomata close.

iii) Carbon dioxide concentration : Low carbon dioxide concentration (such as those that occurs during the day when photosynthesis exceeds respiration), stimulates the active transport of Potassium ions into the guard cells. This transport (as discussed earlier) causes stomata to open and allow CO₂ to diffuse in the mesophyll cells of leaves. At night cellular respiration in the absence of photosynthesis raises CO₂ levels. This halts the inward transport of K⁺, and thus of water, allowing the guard cells to become flaccid and stomata close. Thus transpiration almost stops.

iv) Humidity and vapour pressure : When air is dry, the rate of diffusion of water molecules, from the surfaces of mesophyll cells, air spaces, and through stomata to outside the leaf, increases (Fig. 14.8). So more water is lost, increasing the rate of transpiration. In humid air the diffusion rate is reduced. This decreases the rate of transpiration appreciably.

v) Wind : The air in motion is called wind, which causes increase in rate of diffusion of water molecules. The rate of evaporation from the surfaces of mesophyll cells increases. When air is still, the rate of movement of water molecules (diffusion) is slowed down, thus reducing the rate of transpiration.

vi) Availability of soil water : If there is little water in the soil, less is brought or transported to the leaf cells and less is lost to the environment by transpiration. So when the rate of absorption of water in root cells is reduced, the rate of transpiration is reduced.

Transpiration as a necessary evil

Transpiration has been described as necessary evil because it is an inevitable, but potentially harmful consequence of the existence of wet cell surfaces from which evaporation occurs. Loss of water from the plant can lead to wilting, serious desiccation and often death of a plant if conditions of drought are experienced. There is good evidence that even mild water stress results in reduced growth rate and in crops to economic losses through reduction of yield.

Despite its apparent inevitability it is also of very great importance for the plant.

- i) Water is conducted or transported in most tall plants with the courtesy of transportation pull.
- ii) Minerals dissolved in water are distributed throughout plant body by transpiration stream.
- iii) Evaporation of water from the exposed surface of cells of leaves has cooling effect on plant.
- iv) Wet surface of leaf cells allow gaseous exchange.

TRANSLOCATION OF ORGANIC SOLUTES

Organic solutes are transported by phloem tissue.

Phloem Transport

The phloem is generally found on the outer side of both primary and secondary vascular tissue in plants with secondary growth. The phloem constitute the inner bark. The cells of phloem that conduct

or transport sugars and other organic material throughout the plant are called sieve elements.

In addition to sieve elements, phloem tissue also contains companion cells, parenchyma cells, and in some cases fibres, sclereids and latex containing cells. However, only sieve tube cells are directly involved in transport of organic solutes.

Sieve elements are characterised by 'sieve areas' portions of the cell wall where pores interconnect the conducting cells. Some of the sieve areas of sieve tube members are generally formed in end walls of sieve tube members where the individual cells are joined together to form a longitudinal series called a sieve tube. Sieve plate pores of sieve tubes are essentially open channels, that allow transport between cells (Fig. 14.10).

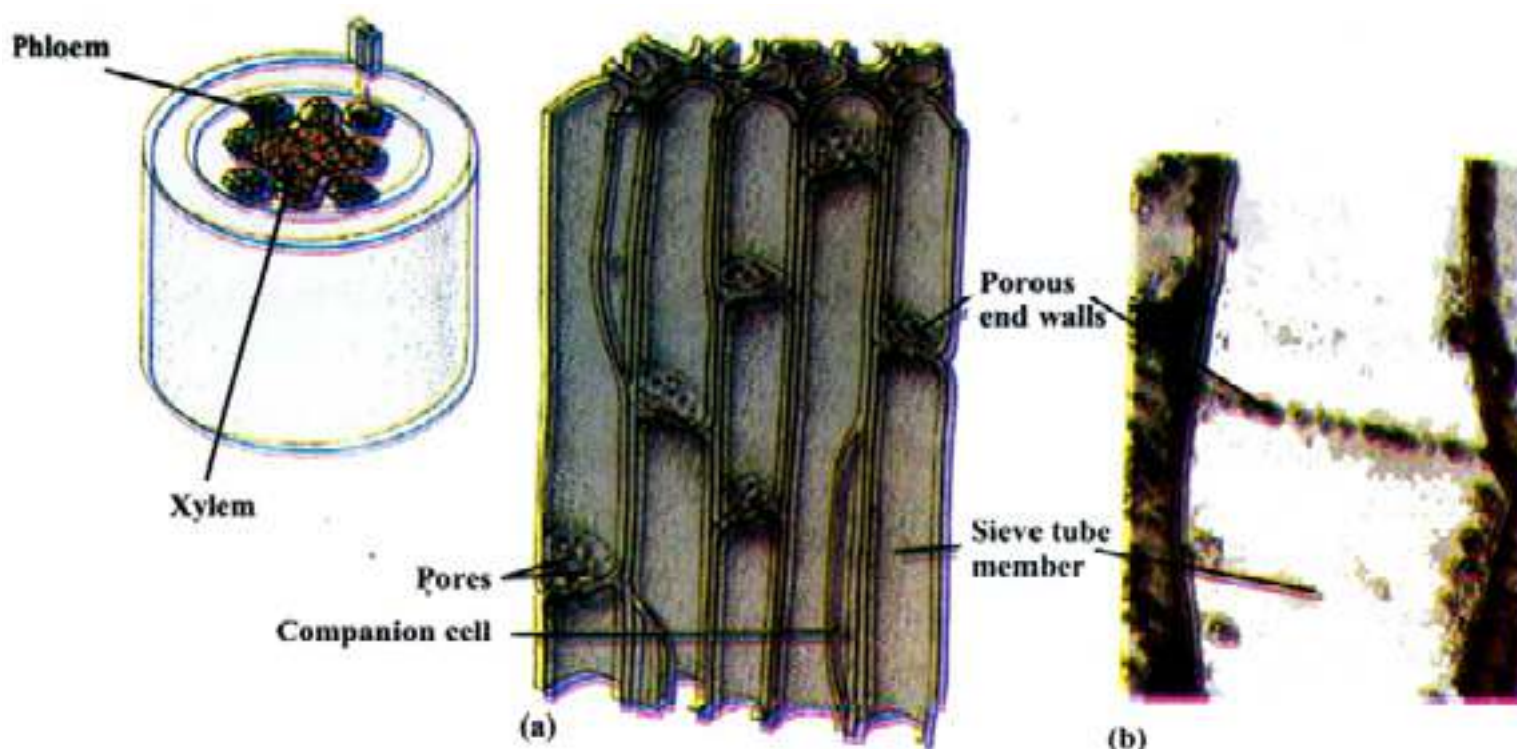

Fig. 14.10 (a) This diagram shows part of the root phloem consisting of sieve tube members stacked end to end. Adjoining end walls have common pores. Each sieve tube member is associated with a companion cell (b) Sieve tube member showing the pores in its end walls. Note the scarcity of cytoplasmic components in these sugar conducting cells.

Each sieve tube member is associated with one or more companion cells. Sieve tubes and companion cells are in communication with each other by plasmodesmata. Companion cells supply ATP and proteins to sieve tubes. The photosynthetic products from photosynthesizing cells, the mesophyll and palisade layer of leaf, pass into sieve tubes, through the companion cell via plasmodesmata.

Patterns of Transport

Phloem transport does not occur exclusively in an upward or a downward direction and is not defined with respect of gravity. Transport or translocation occurs from the areas of supply (sources) to areas of metabolism or storage (sinks).

The areas of sources include any exporting organ typically a mature leaf, or storage organ, that is capable of

- i) Storing photosynthate in excess of its own needs.
- ii) Storage organ during the exporting phase of its development. In biennials e.g root of beet is a sink in first growing season, but becomes source in the next growing season, when sugars are utilized in growth of new shoots.
- iii) Sinks are the areas of active metabolism or storage for example roots, tubers, developing fruits, immature leaves, and even the growing tips of stem and root.

The composition of materials flowing in phloem has been studied by using aphids - the insects which are phloem feeders (Fig 14.11). These insects insert their stylets into stem or leaf and extend them to puncture a sieve tube. The pressure in the sieve tube cell forces sap through aphid's digestive tract and out its posterior end as droplets called "honey dew". The composition of honey dew have revealed that it contains 10-25% dry matter 90% or more of which is sucrose. Nitrogenous compounds are about 1%.

The movement in phloem is from source to sinks in most of the plants during active photosynthesis.

*Animation 14.6 Absorptive Root
Source & Credit: cas.miamioh*

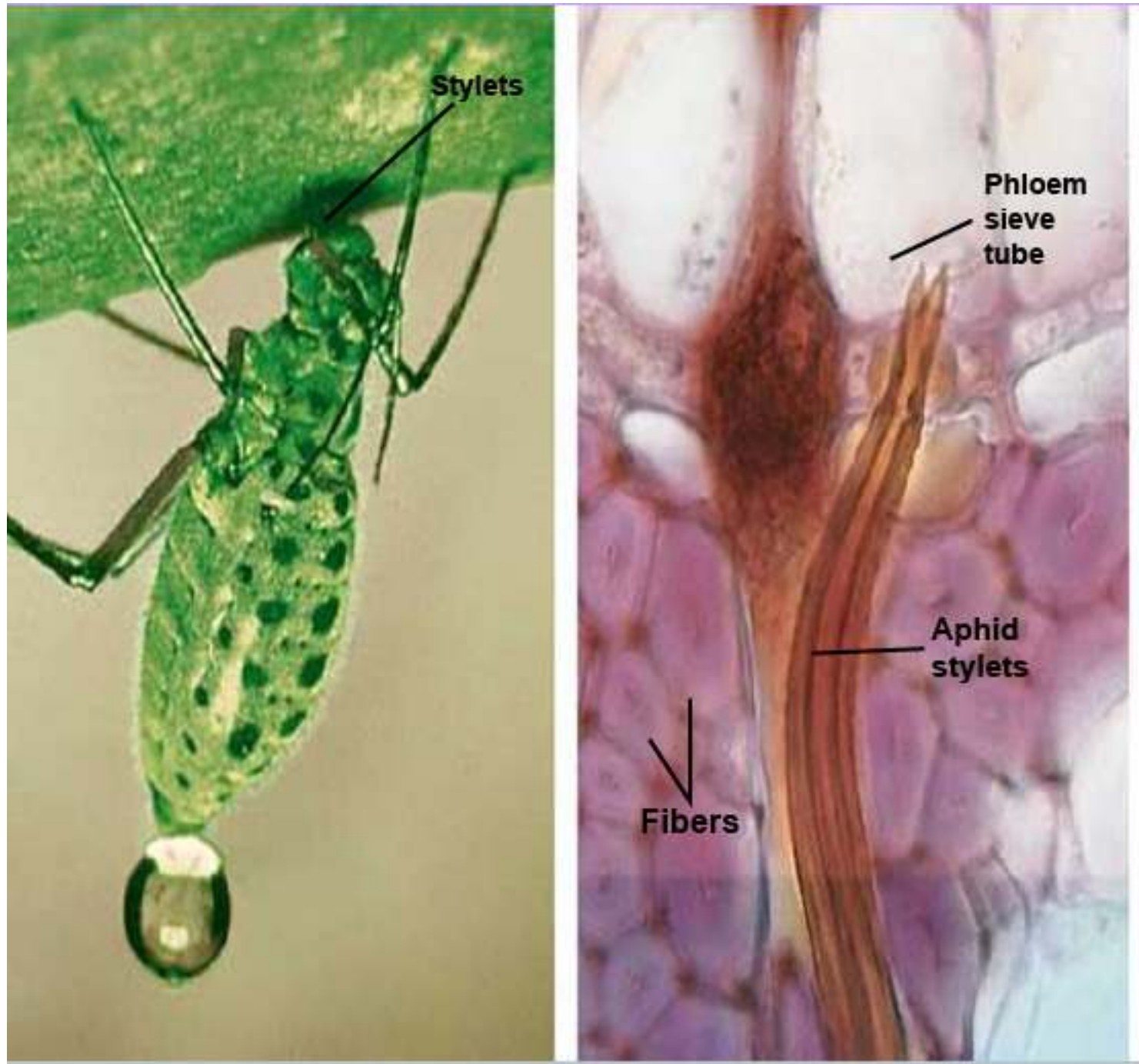

Fig.14.11 Collection of phloem sap using aphids

The Mechanism of phloem translocation/transport

The theory called, Pressure - Flow Theory, is the most acceptable theory for the transport in the phloem of angiosperms. We have considerable evidence to support this theory. There were two main categories of theories to account for movement of sap in phloem. The active theories involving the use of energy for the movement of materials in phloem, and the passive theories in which no use of energy was involved. The active theories have all been abandoned as there is not much evidence to support these theories.

Now we are left with passive theories of transport / translocation. These include:

short distance transport (involving 2 - 3 cells). Thus sucrose diffuses through plasmodesmata to sieve tube cell or sieve element, raising the concentration of sucrose in it. (Fig. 14.12) The pathway taken by sucrose is symplast in most cases; but in some, apoplastic movement does take place. The sucrose is actively transported to the sieve elements. (3) The water moves by osmosis from the nearby xylem in the leaf vein. This increases the hydrostatic pressure of the sieve tube element.

(4) Hydrostatic pressure moves the sucrose and other substances in the sieve tube cells, and moves to sinks e.g. fruits and roots. In the storage sinks, such as sugar beet root and sugarcane stem, sucrose is removed into apoplast prior to entering symplast of the sink.

(5) Water moves out of sieve tube cell by osmosis, lowering the hydrostatic pressure.

In symplastic pathway, sucrose (or sugars) move through plasmodesmata to the receiver cell. Thus according to pressure flow theory, the pressure gradient is established as a consequence of entry of sugars in the sieve elements at the source; and removal of sugars (sucrose) at the sink (Fig. 14.13). The energy driven entry of sugars in sieve tube elements, generate high osmotic pressure in the sieve tube elements of the source causing a steep drop in the water potential.

(6) The presence of sieve plates greatly increases the resistance along the pathway and results in the generation and maintenance of a substantial pressure gradient in the sieve elements between source and sink.

The sieve element's contents are physically pushed along the transportation pathway by bulk flow, much like water flowing through a garden hose.

The pressure flow theory accounts for the mass flow of molecules within phloem. It may be noted that the transportation of photosynthate or carbohydrates from the mesophyll cells to phloem tissue involves diffusion and active transport (carrier mediated transport). Then in phloem tissue (sieve tubes) the movement of materials is according to pressure flow theory.

Again in the sink cells when the sugar and the carbohydrates are passed from the phloem tissue, diffusion and carrier mediated transport, either passive or active, takes place, (see table 14.1).

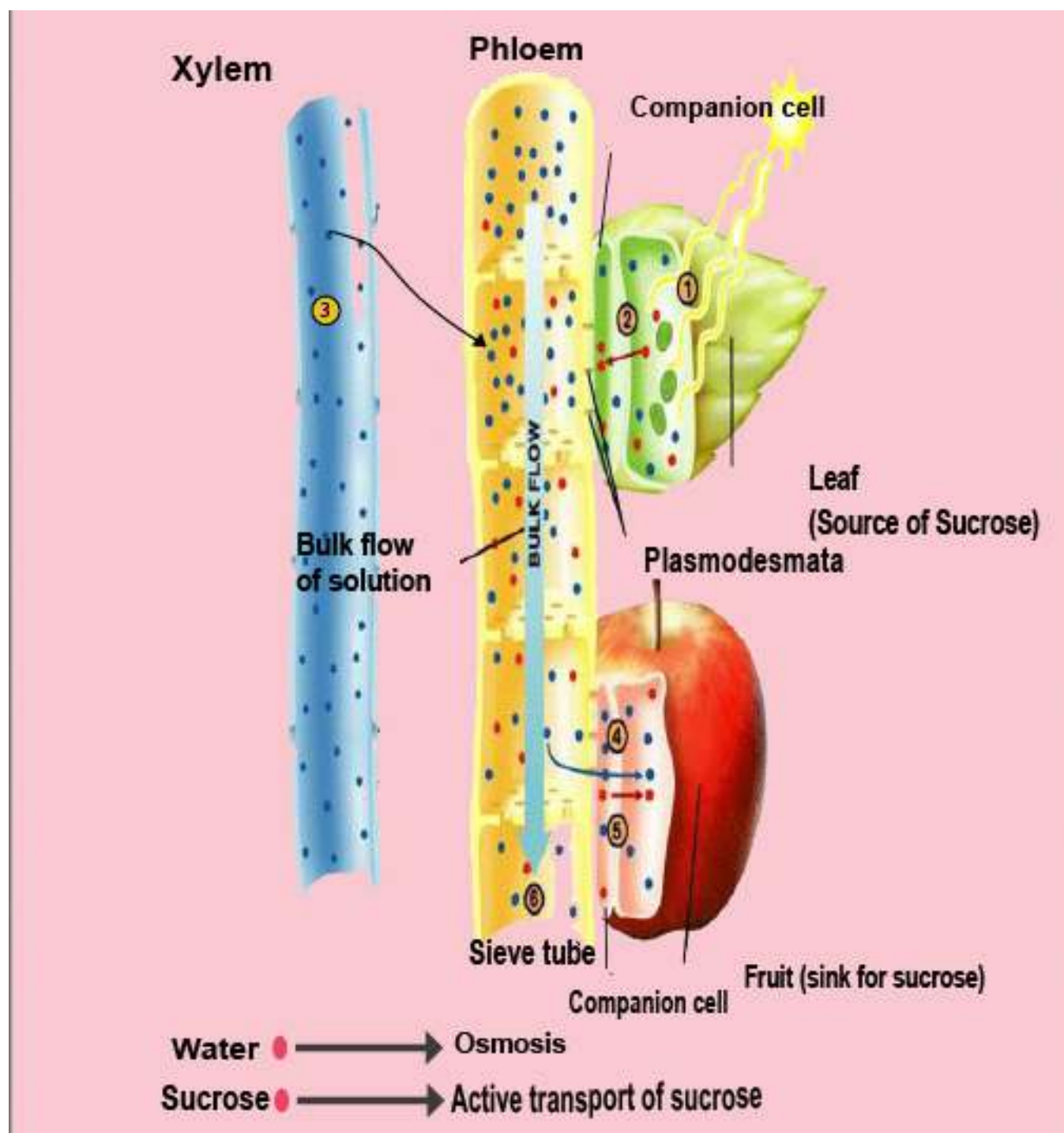

Fig. 14.13 The Pressure-flow theory (1) A photosynthesizing leaf manufactures sucrose (red dots), which (2) is actively transported (red arrow) into a nearby companion cell. The sucrose diffuses to sieve-tube element through plasmodesmata, raising the concentration of sucrose. (3) Water (blue dots) leaves nearby xylem and moves into the "leaf end" of the sieve tube by osmosis (blue arrow), raising the hydrostatic pressure. (4) The same sieve tube connects to a developing fruit (sink); sucrose enters the companion cells by diffusion through plasmodesmata. It is then actively transported out of the companion cells and into the fruit cells. (5) Water moves out of the sieve tube by osmosis, lowering the hydrostatic pressure within the tube. (6) High pressure in the leaf end of the phloem and low pressure in the fruit end cause water, together with any dissolved solutes, to flow in bulk from leaf (source) to fruit. (Black arrow).

TRANSPORT IN ANIMALS

Unicellular animals have maximum surface area to volume ratio; and most of the substances move into or out of their bodies by simple diffusion, osmosis, active transport, and facilitated diffusion. So there are no special transport systems involved. Same is true of simple multicellular animals which are aquatic. But complex multicellular animals possess highly organized, and well developed transport system, in the form of blood vascular system.

Transportation in *Hydra*

It is fresh water in habitat. The body is two layered; the outer ectoderm and inner endoderm; in between them is mesogloea which is non-cellular. The outer surfaces of the ectoderm cells are exposed to the water in which the animal lives. Water, dissolved O_2 , and food is taken into the coelenteron (enteron) of *Hydra* by the movement of tentacles, and flagella which are present in most cells of endoderm.

The materials and food may be absorbed or taken up by endocytosis into endodermal cells. The indigestible and partly digested food is removed by exocytosis from these cells, into digestive cavity (coelenteron). Ectodermal cells get food from endodermal cells by diffusion.

The ectodermal cells directly exchange materials with the surrounding water (Fig 14.14). They also get nutrients from endodermal cells.

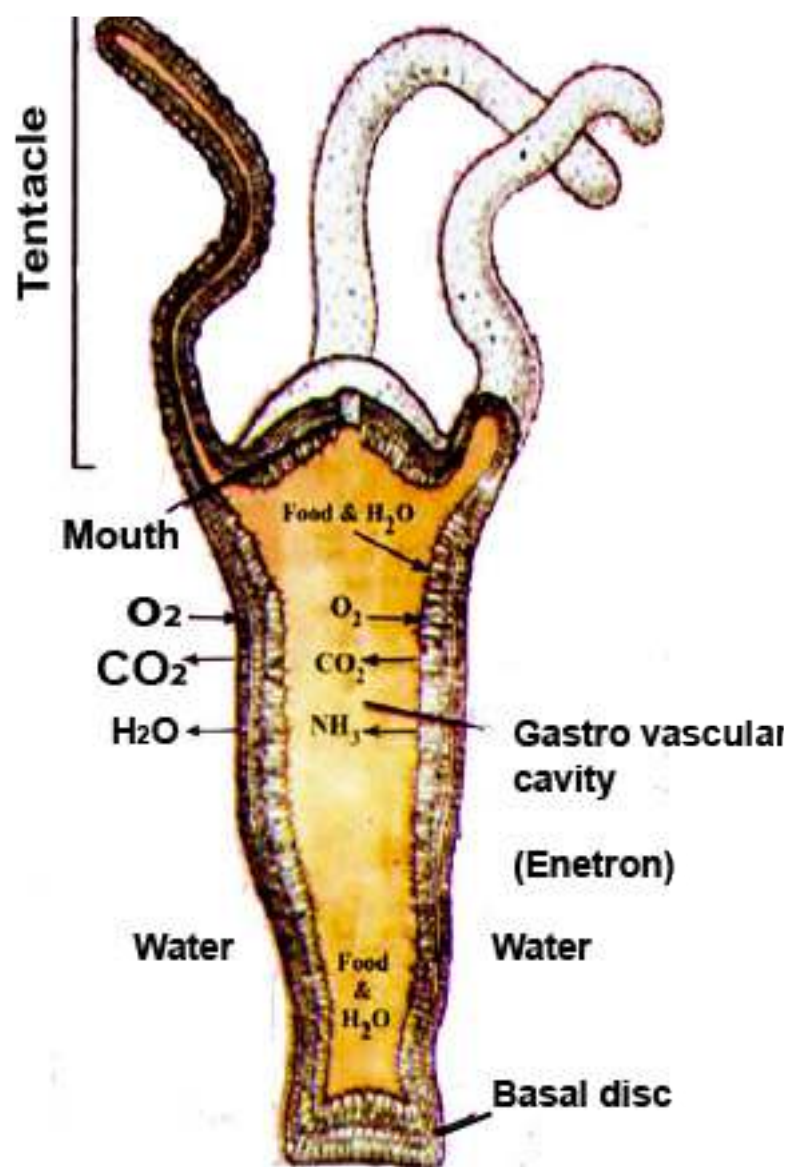

Fig.14.14 Hydra

Transportation in *Planaria*

The body of *Planaria* is flat, so the most of its cells are exposed to the outer water. Diffusion is the process involved in the movement of materials into and out of the cells.

There is no special transport system in *Planaria*. The reasons are:

- (i) The body of *Planaria* is flat, and provides greater surface area for the exchange of materials, between the body and the environment.
- (ii) *Planaria* is acoelomate i.e. there is no body cavity and the mesodermal layer or mesenchyme is composed of loosely packed cells between ectoderm and endoderm. Whatever materials, such as O_2 , diffuse in the ectoderm, pass to mesoderm cells and then diffuse into endoderm cells. For the removal of wastes the same route is reversed. Intestinal caecae reach near almost every cell of the body and digested food is provided to the cells by diffusion. The endoderm cells, can also acquire food, water, dissolved minerals, and to some extent O_2 , and remove wastes into the gut.

CIRCULATORY SYSTEM

In the body of larger and complex animals, there is very little exposed surface area to volume ratio. Most of the cells are not exposed to the external environment directly and it becomes very difficult to transport materials by simple diffusion. Complex animals have evolved transport systems in the form of blood vascular system or circulatory system.

Characteristics of Circulatory System

A circulatory system accounts for rapid mass flow of materials from one part of the body to the other, where diffusion would be too slow.

There are three characteristics of a circulatory system.

- (A) A circulatory fluid - the blood.
- (B) A contractile pumping device - which may be the modified blood vessel or a heart.
- (C) Tubes, which can transport the circulatory fluid (blood) to and from cells of the body. These tubes are the blood vessels. Materials must be exchanged between the circulatory fluid and other body cells.

Open and Closed Circulatory System

The circulatory systems of animals are divided into two main types:

a) Open circulatory system: It is observed in animals belonging to Phylum Arthropoda (crustaceans, spiders, insects) and Phylum Mollusca (snails and clams) and group of protochordates, the tunicates.

b) closed circulatory system: It is observed in animals belonging to annelids, cephalopod molluscs (squids and octopus), echinoderms and vertebrates.

The differences between open circulatory system and closed circulatory system would be clear by studying the comparison between circulatory systems of earth worm and cockroach, (see table 14.1).



Table 14.1 Comparison between closed and open circulatory systems.

Closed circulatory system e.g. Earthworm (<i>Pheretima</i>)	Open circulatory system e.g. cockroach (<i>Periplaneta</i>)
1. Blood always remain in the blood vessels, and does not come in direct contact with other cells of the body.	1. Blood does not remain enclosed in the blood vessels and comes in direct contact with other body cells, and bathes them.
2. Inter connected system of arteries , veins, and capillaries present.	2. There are no typical arteries, veins, and capillaries and for much of the time the blood called haemolymph flows in the cavities or sinuses of body cavity (hoemocoel) around the viscera (perivisceral sinus) and around the nerve cord (perineural sinus).
3. Exchange of nutrients and waste products between the blood and tissues via tissue fluid occurs through capillaries.	3. Exchange of nutrients and waste products between the blood and tissues occurs when blood directly bathes the tissues.
4. The system also transports gases i.e. oxygen and carbon dioxide.	4. This sytem does not transport gases i.e. oxygen and carbon dioxide (these gases are transported by tracheal system).
5. Respiratory pigment haemoglobin is dissolved in blood. Nucleated white blood cells are present.	5. No respiratory pigment and blood is colourless in which nucleated white blood cells float.
6. This is regarded as the most advanced type, having greater efficiency, maintaining the blood pressure and economy of blood volume.	6. This is regarded as primitive having lesser efficiency and does not maintain blood pressure.
7. In earthworm there are 4 or 5 pairs of lateral hearts present on the lateral side of oesophagus in 7th to 13th segments. Hearts pump the blood from the dorsal to the ventral blood vessel.	7. In cockroach the heart is 13-chambered, tubular vessel present in the pericardial sinus and placed in mid-dorsal region below terga in abdominal region. On the side of the pericardial sinus there are alary muscles helping in the flow of blood. Each heart chamber has a pair of lateral openings, the ostia.
8. There are three main longitudinally running blood vessels, dorsal, ventral and sub-neural, which are interconnected through capillaries and commissural vessels.	8. The portion of the tubular dorsal vessel which extends in the thoracic and head region is called the "aorta". It opens anteriorly in the haemocoel of the head by funnel shaped opening.

9. The dorsal vessel collects blood from the 14th segment backwards. In the first 13 segments it becomes distributing channel and sends its blood to hearts and anterior end of the body. Ventral vessel is the chief distributing vessel with backward flow. The subneural vessel is collecting vessel and the flow of blood is backwards. It communicates with dorsal blood vessel through commissural vessels.

9. The flow of blood from heart to, aorta to, haemocoel in head, to perivisceral sinus, to perineural sinus, to pervisceral sinus, to pericardial sinus, and to heart through ostia.

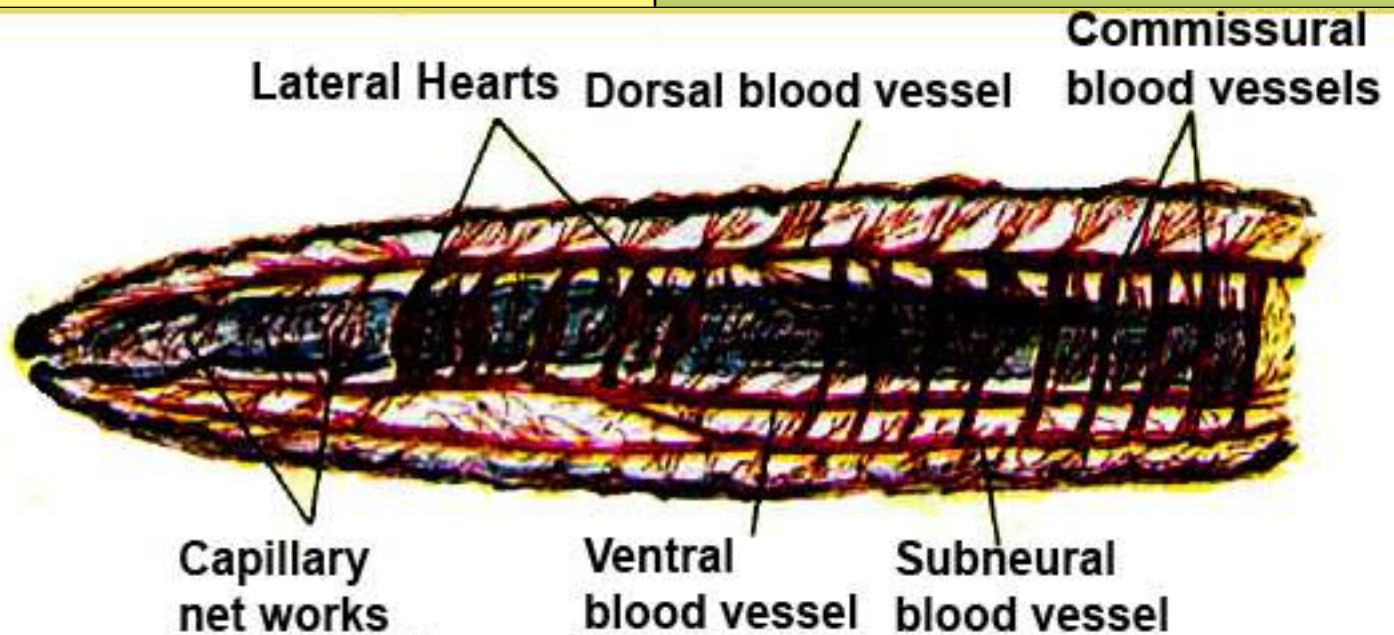

Fig. 14.15 Closed circulatory system of earthworm

Animation 14.8: Closed circulatory system of earthworm
Source and Credit: waterwereld

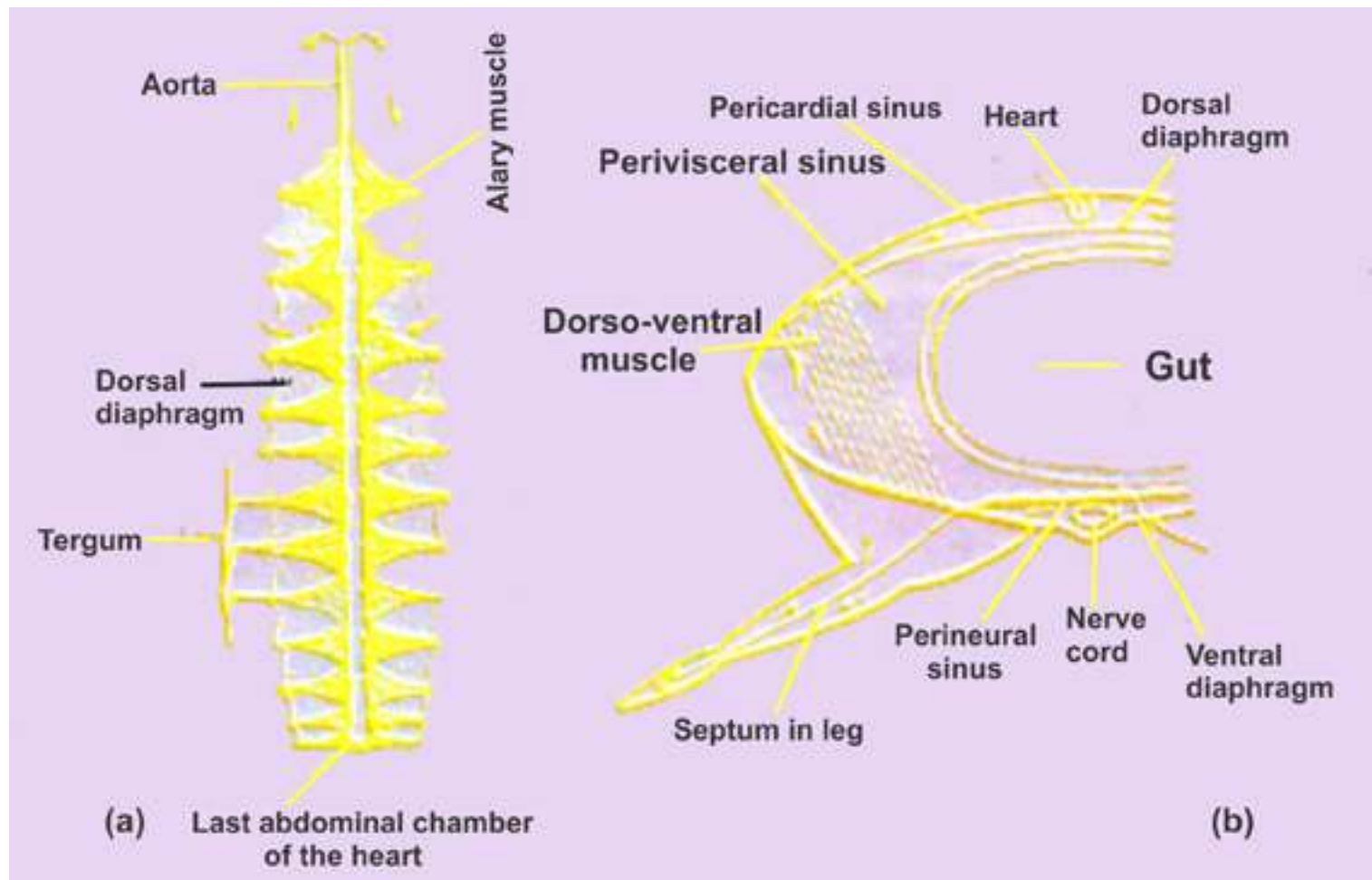

Fig.14.16 Open circulatory system of cockroach, (a) The heart with alary muscle and dorsal diaphragm, (b) T.S of cockroach through thorax showing various sinuses.

Vertebrate blood circulatory system

The components of vertebrate blood vascular system are typical of a circulatory system-blood, heart, blood vessels (arteries, capillaries and veins). All vertebrates have closed circulatory system. In addition there is lymphatic system which also aids in transportation.

Heart pumps the blood to different parts of the body via aorta and arteries. Arteries break into fine blood vessels, the capillaries. These join to form veins which bring blood back to the heart. The capillaries are sites where exchange of materials between blood and body tissues takes place.

Evolution of vertebrate heart

The heart of fishes have sinus venosus, an atrium, a ventricle, and bulbus arteriosus or conus arteriosus. Sinus venosus receives deoxygenated blood from the body, and then blood is passed to atrium, which on contraction passes it to ventricle. Ventricle has thick muscular wall. When the muscles of ventricle contract, they push the blood via conus arteriosus or bulbous arteriosus (proximal swollen portion of ventral aorta).

Thus the heart of fishes works as a **single circuit heart**. The blood flows in one direction only, from sinus venosus to atrium then to ventricle and to ventral aorta via bulbus arteriosus or conus arteriosus to the gills and then to the body. The blood returns to the heart in the sinus venosus. The oxygenated blood is supplied from dorsal aorta through coronary arteries, to the heart and is carried back by coronary veins from the heart).

The heart of the fishes never receives oxygenated blood. It is only the deoxygenated blood which passes through different chambers of the heart. (Fig. 14.18 a). The valves present in the heart control the flow of blood in single direction i.e. sinus venosus → atrium → ventricle conus arteriosus → ventral aorta → gills → dorsal aorta → body → sinus venosus. So the heart of fishes functions as a single circuit heart.

In amphibians the heart is three chambered with regard to auricles and ventricles. There are two auricles and one ventricle. In addition, sinus venosus and truncus arteriosus are also present. Sinus venosus receives de-oxygenated blood from two superior venacavae (precavals) and one inferior vena cava (postcaval) from different parts of the body. This blood passes to the right auricle. The oxygenated blood from lungs is poured via pulmonary veins into left auricle. Both auricles contract simultaneously and blood is passed into the ventricle. There is a complete mixing of oxygenated and deoxygenated blood in the ventricle. When ventricle contracts, it pushes blood via truncus arteriosus, to two carotids, two systemics, and two pulmocutaneous arches. (Fig. 14.19b).

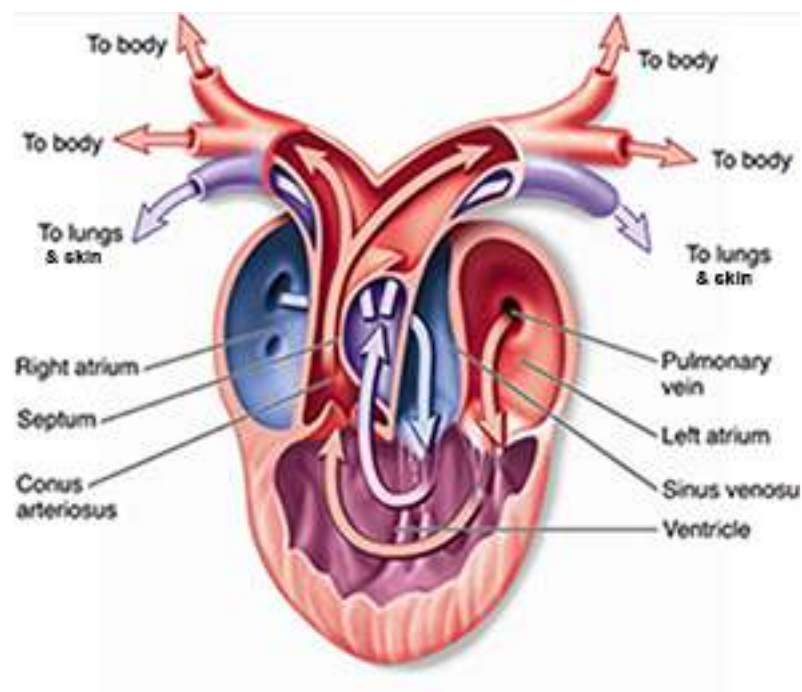

Fig. 14.17 Structure of heart of frog

Animation 14.9: Structure of heart of frog
Source and Credit: multilearn

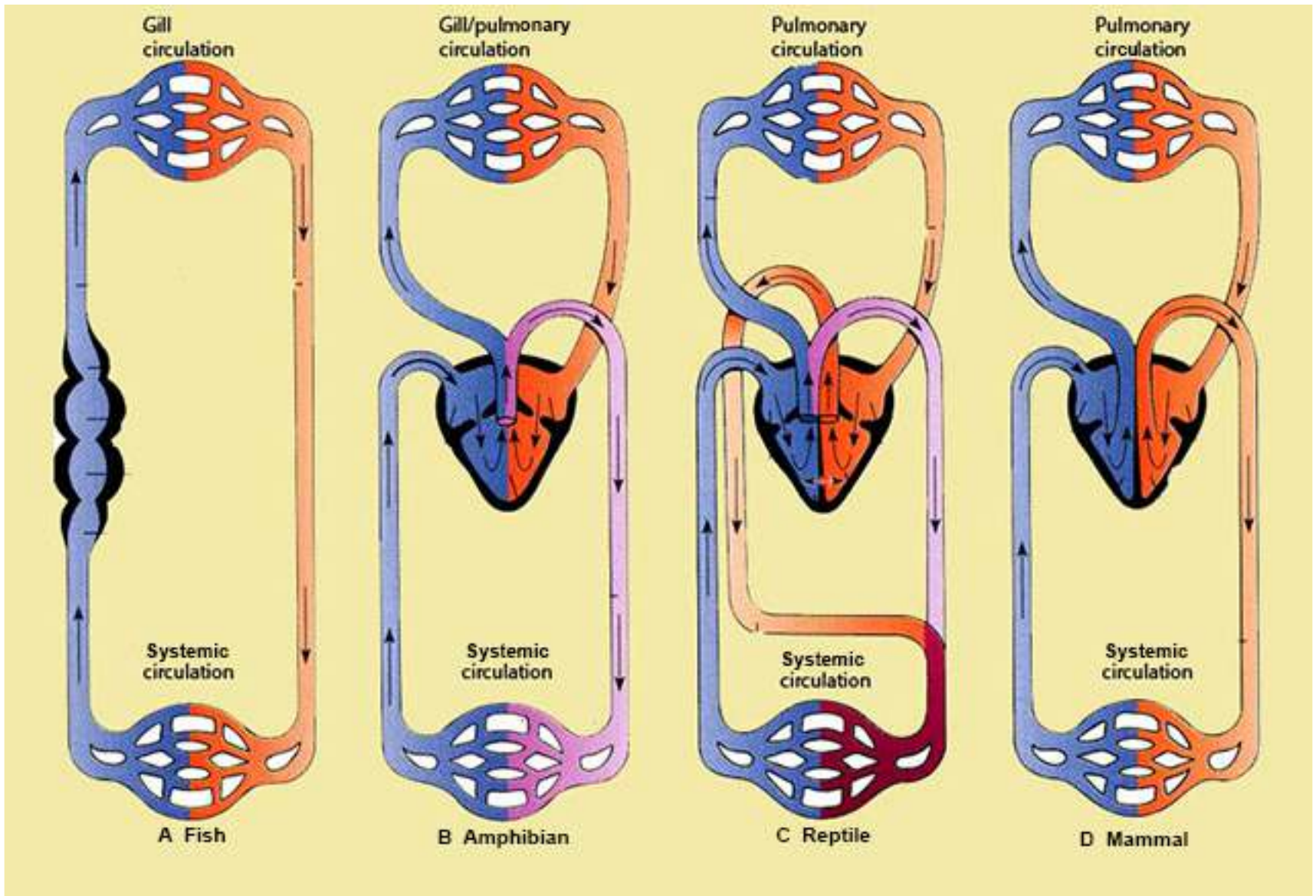

Fig.14.18 A schematic comparison of vertebrate heart and circulation of blood. (A) In modern fish the blood is pumped to the gills, where it picks up oxygen. The oxygenated blood (red) then passes without further pumping to the systemic circulation, where it gives up its oxygen before returning to the heart. (B) In amphibians the blood that has picked up oxygen in the gills and/or lungs returns to the heart, from which it is pumped into the systemic circulation. Extensive mixing (purple) of the pulmonary and systemic flows occurs in the heart. (C) In reptiles the pattern is much the same, except that the ventricles are partially divided, so less mixing takes place. (D) In mammals and birds the two halves of the heart are effectively separated.

The heart of reptiles and all other amniotes practically functions as four chambered heart. There are two auricles in the heart of reptiles. The reptiles have incompletely partitioned ventricle; but in crocodiles, the interventricular septum is complete and heart is four chambered. In all reptiles the left and right systemic arches carry oxygenated blood and arise from a region of ventricle called

cavum venosum - into which left ventricle directs its blood. The deoxygenated blood from the right atrium is directed towards the entrance of the pulmonary trunk which is also located or starts from a pocket the cavum pulmonale, on right side of ventricle- in the animals (reptiles) which do not have completely divided ventricle. Although the two systemic arches start from the ventricle separately, they are also interconnected at their base by an opening. The heart of reptiles birds and mammals functions as **double circuit heart**. (Fig. 14.19c).

In the birds and mammals, the heart is four - chambered, and oxygenated and deoxygenated blood does not mix at all. The pulmonary trunk arises from right ventricle and leads to the lungs.

The aortic trunk emerges from the left ventricle and leads to carotid and systemic arches. The left systemic disappears in birds and right systemic, most of it, disappears in mammals. (Fig. 14.19 D).

In reptile, birds and mammals, as a result of these modifications, all blood returning to the right side of the heart passes to the lungs. After oxygenation, blood returns to left atrium from the lungs via pulmonary veins. Left atrium passes this blood to left ventricle - which on contraction pumps it to different parts of the body, and again blood returns to right atrium (Fig.14.18D). **Pulmonary circulation** is by pulmonary arch carrying deoxygenated blood from right ventricle of heart to lungs, and the blood returns to left atrium after oxygenation via pulmonary veins.

Likewise the systemic arch distributes blood to different parts of the body, and then the blood from the body returns to the heart, in the right atrium via precaval and postcaval. This is **systemic circulation**. So the hearts of amphibians, reptiles, birds and mammals have both pulmonary and systemic circulation.

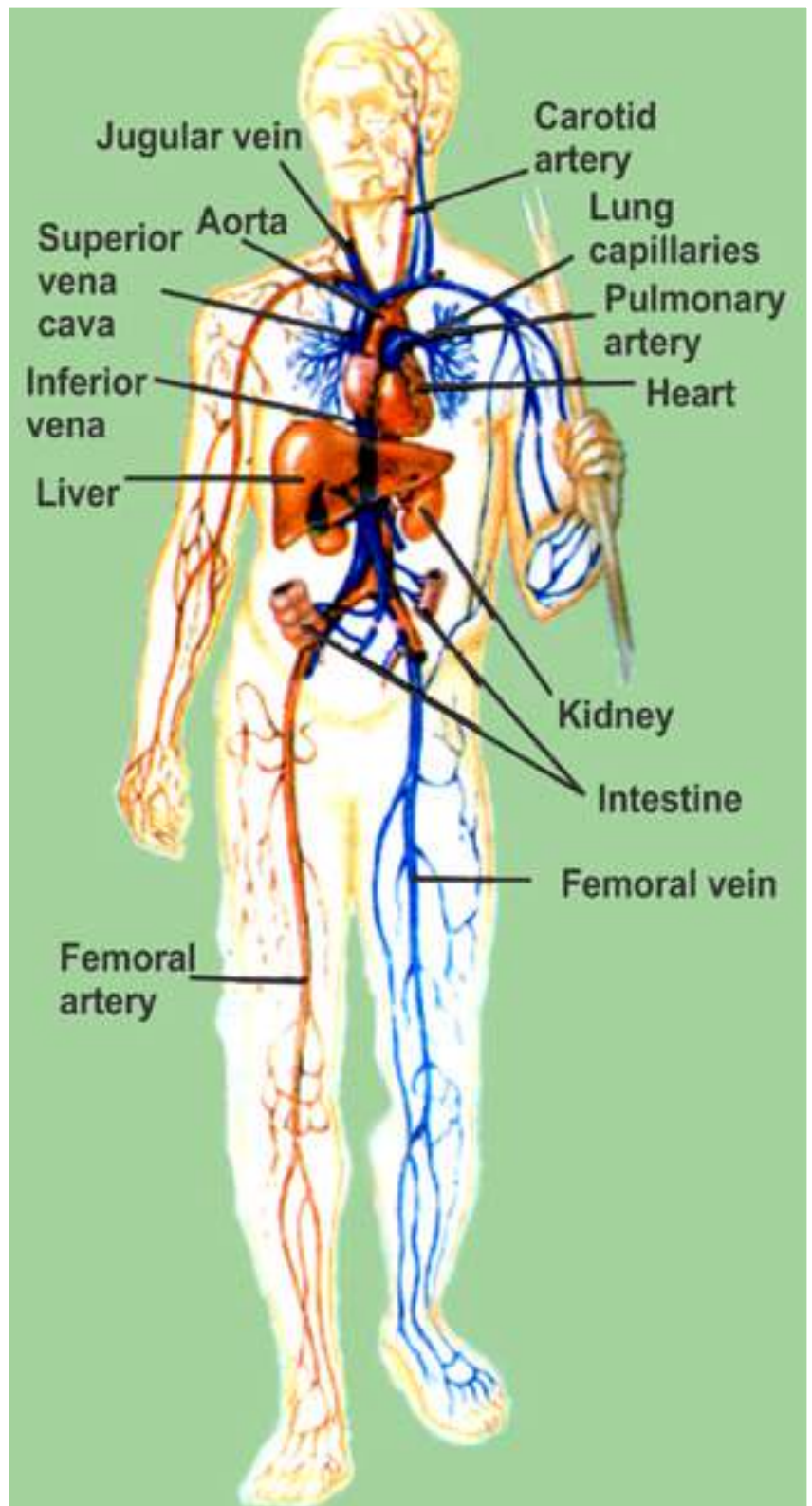

Fig. 14.19 The human circulatory system

TRANSPORT IN MAN :

In humans, in addition to blood circulatory system, there is also another transport system, the lymphatic system, described latter in this chapter.

Blood circulatory system

The circulatory system of humans have the same 3 basic components.

- (A) Circulating fluid - the blood.
- (B) The pumping organ - the heart.
- (C) The blood vessels, arteries, capillaries and veins.

(A) The circulatory fluid-the blood

The blood is the medium in which dissolved nutrients, gases, hormones, and wastes are transported through the body. It is made up of two main components, (i) plasma and (ii) cells or cell - like bodies (white blood cells, red blood cells, platelets). The weight of the blood in our body is about 1/12th of our body.

(i) PLASMA : It has been estimated that in a normal person plasma constitutes about 55% by volume of the blood, and cells or cell-like bodies about 45% by volume of the blood.

Plasma is primarily water in which proteins, salts, nutrients and wastes are dissolved. Water constitutes about 90% of plasma, 10% are dissolved substances. Most of the dissolved substances are maintained at a constant or nearly constant level, but others occur in varying concentrations.

The substances dissolved or present in plasma vary in their concentrations, with the condition of the organism and with the portion of the system under examination. The solutes can be divided into six categories:

Inorganic salts (ions) - Plasma proteins - Organic nutrients - Nitrogenous waste products - Special products being transported and gases which are dissolved.

1. Inorganic ions or mineral ions. Together the inorganic ions and salts make up 0.9 per cent of the plasma, of humans, by weight; more than two thirds of this amount is sodium chloride the ordinary table salt. Even if the total concentration of dissolved substances remains the same, shifts

in the concentration of particular ion can create serious disturbances. The normal pH of human blood is 7.4; and it is maintained between narrow limits, because the change in pH would affect the chemical reactions of the body.

2. The plasma proteins constitute 7-9 percent by weight of the plasma. Most of these proteins are synthesized in the liver. Some of the globulins, called immunoglobulins or antibodies, are produced in response to antigens, by lymphocytes; and then are passed to plasma, and lymph.

The proteins like prothrombin acts as a catalyst in blood clotting process. Fibrinogen takes part in the blood clotting process. Immunoglobulins play important role in body's defenses against disease.

3. Organic nutrients in the blood include, glucose, fats, phospholipids, amino acids and lactic acids. Some of them enter the blood from the intestine (absorption). Lactic acid is produced in muscles as a result of glycolysis, and is transported by blood to liver. Cholesterol is an important constituent, it is metabolized to some extent, but also serves as precursor of steroid hormones.

4. Plasma also contains nitrogenous waste products formed as a result of cellular metabolism. These products are carried from the liver where they are produced, to the organs from where they are removed i.e. kidneys. Urea and small amounts of uric acid are present in plasma.

5. All the hormones in the body are carried by blood - so they are present in the plasma.

6. The gases such as CO_2 , O_2 are present in the plasma of the blood.

Animation 14.10: Blood Circulatory system
Source & Credit: my-ecoach

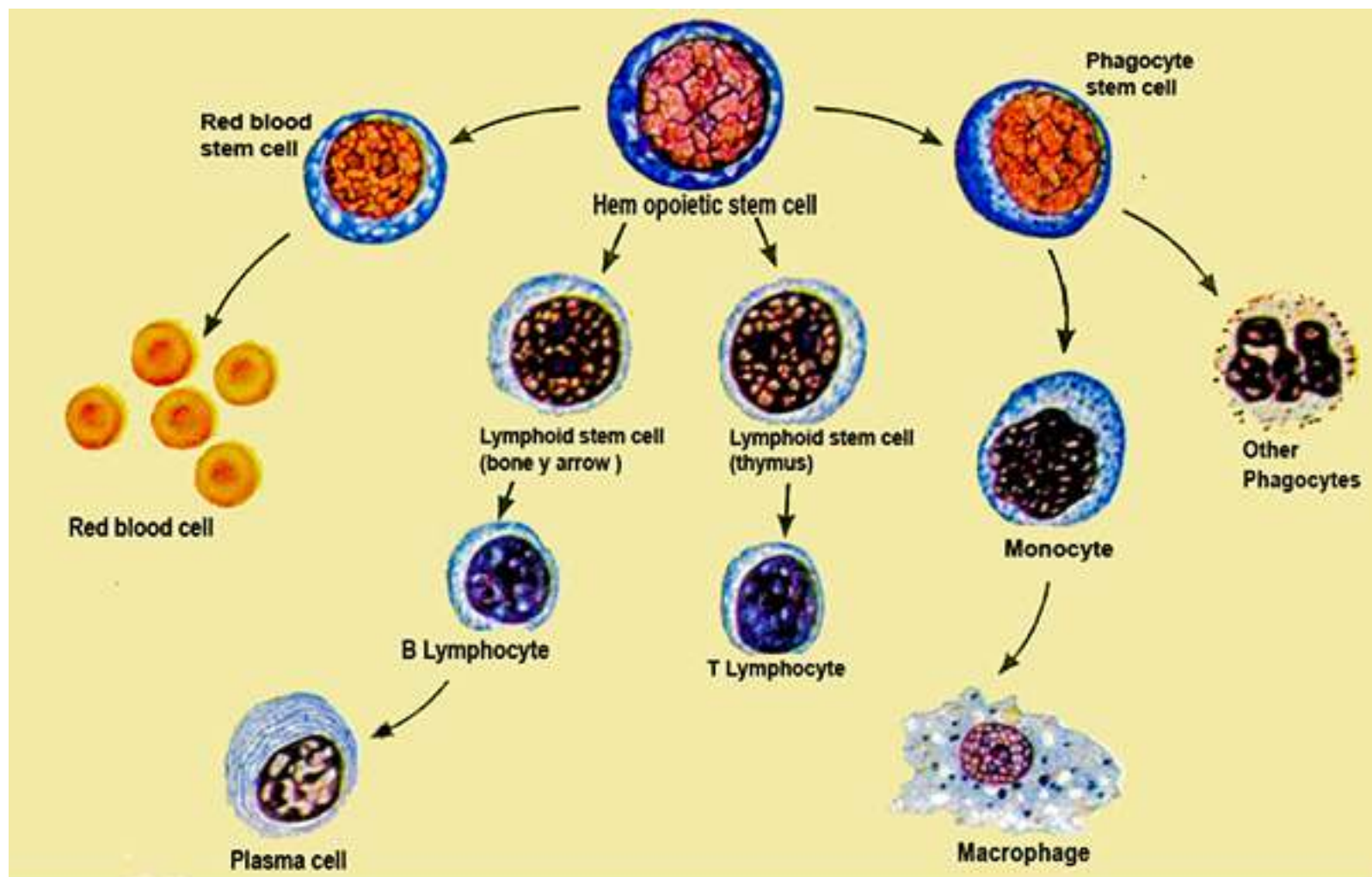

Fig.14.20 Red blood cells (erythrocytes) and white blood cells (leucocytes) develop from stem cells in bone marrow.

(ii) BLOOD CELLS AND CELL LIKE BODIES : These include red blood cells, (Erythrocytes), white blood cells (leucocytes) and platelets.

(a) Red blood cells (Erythrocytes) : These are most numerous of the cells in the blood. A cubic millimeter contains 5-1/2 million of them in males, and 4-1/2 million in females. These cells, when formed, have nucleus, but it is lost before they enter the circulatory fluid or blood. 95% of the cytoplasm of red blood cells is the red pigment, called haemoglobin the remaining 5% consists of enzymes, salts and other proteins. The red cells once mature, do not divide.

Red blood cells are formed principally in the red bone marrow of short bones, such as the sternum, ribs and vertebrae (Fig. 14.20). In the embryonic life, they are formed in the liver and spleen. The average life span of red blood cell is about four months after which it breaks down and disintegrates in the liver and spleen - partly by phagocytes by phagocytosis (Table -14.2)

(b) White blood cells (Leucocytes): These blood cells are colourless, as they do not contain

pigments. One cubic millimetre of blood contains 7000 to 8000 of them. They are much larger than the red blood cells. There are at least five different types which can be distinguished on the basis of the shape of the nucleus and density of granules in the cytoplasm (Table 14.2). They can be grouped into two main types, granulocytes and agranulocytes. Granulocytes, include neutrophils, eosinophils and basophils. They are formed in the red bone marrow (Fig. 14.20). Agranulocytes are formed in lymphoid tissue, such as those of the lymph nodes, spleen, tonsils, adenoids and the thymus. Agranulocytes include monocytes and lymphocytes (B and T). Monocytes stay from 10- 20 hours in the blood, then enter tissues and become tissue macrophages, performing phagocytic function (Fig. 14.24) Lymphocytes have life spans of months or even years; but this depends on the body's need for these cells.

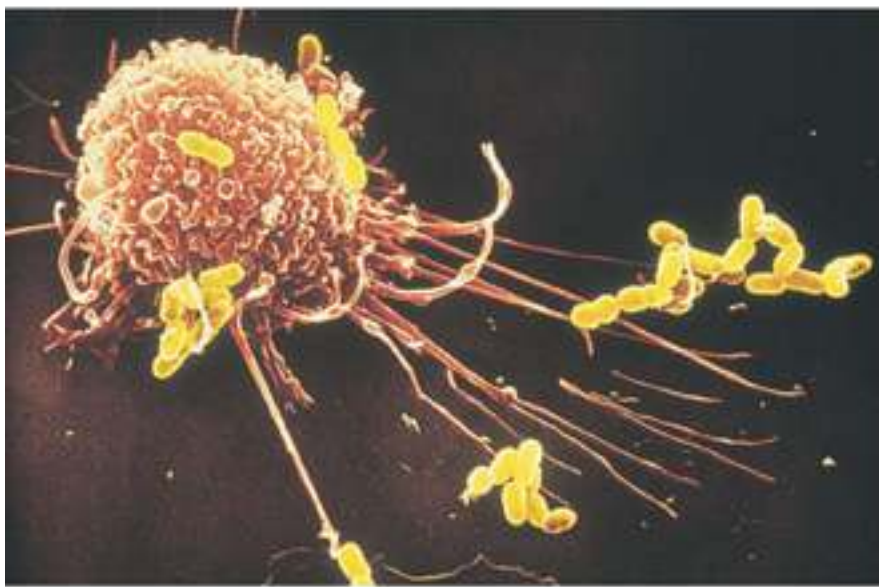

Fig. 14.21 A macrophage in Action

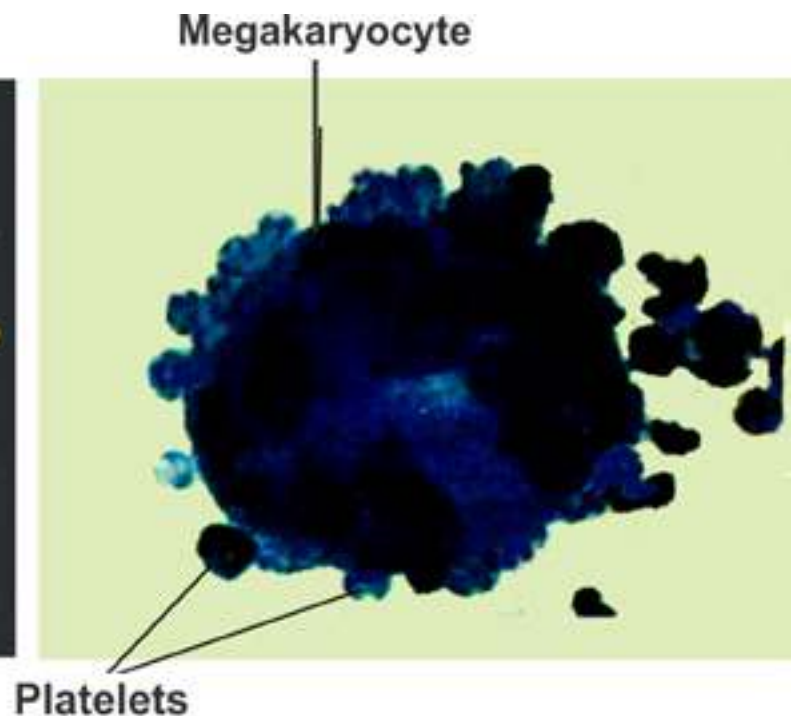
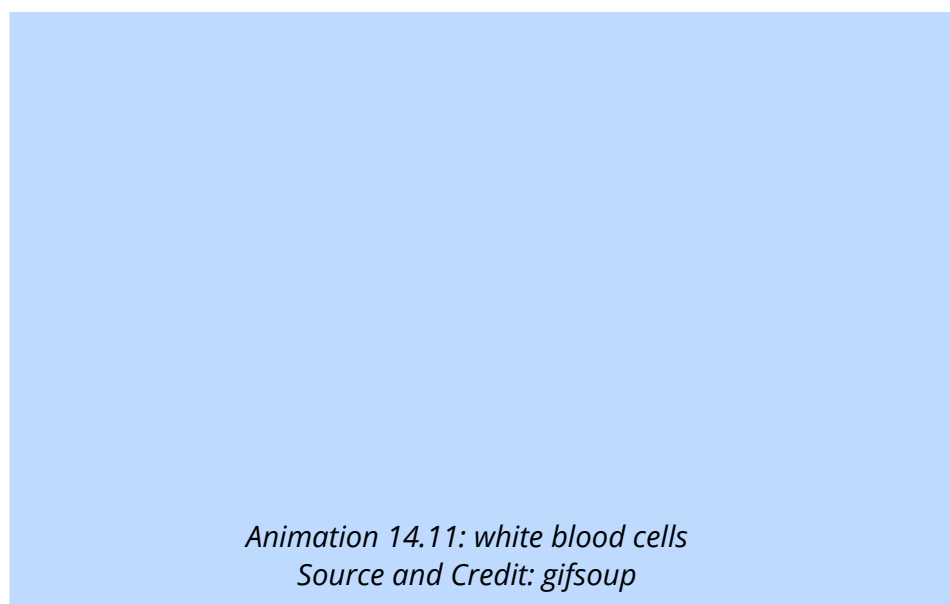

Fig. 14.22 The production of platelets



Animation 14.11: white blood cells
Source and Credit: gifsoup

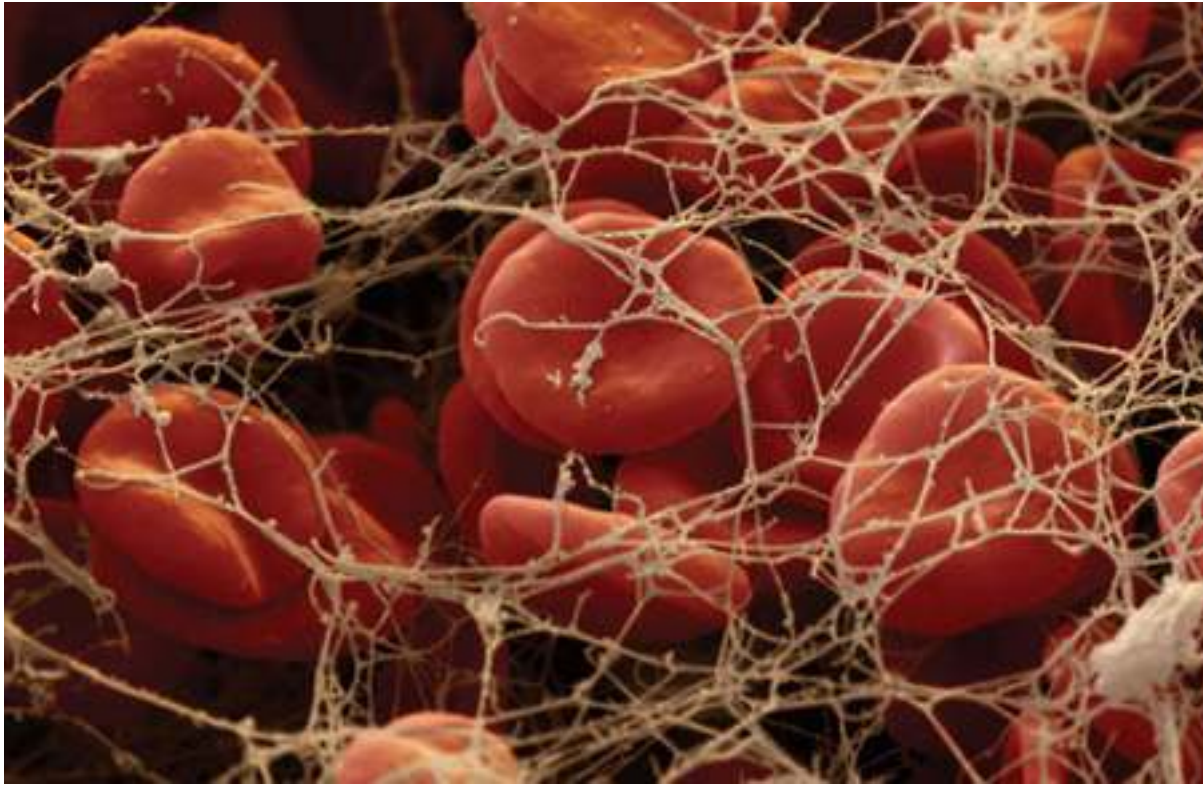





Fig. 14.23 Blood clotting

Animation 14.12: Blood Cells
Source & Credit: imgur

Cell Type	Description	Average Number present	Major Function
Red blood cell (erythrocyte)	 Biconcave disc without nucleus, Approximately 8 μ m in diameter	5,000,000 per mm ³	Transports oxygen and a small amount of carbon dioxide.
White blood cell (leucocytes)		7500 per mm ³	Destroys small particles by phagocytosis.
(a) Granulocytes	About twice the size of red cells, nucleus two to five lobed	62% of white cells	
1. Neutrophil		2% of white cells	Inactivates inflammation-producing substances; attacks parasites.
2. Eosinophil	About twice the size of red cells, nucleus bilobed	Less than 1% of white cells	Releases heparin to prevent blood clots and histamine, which causes inflammation.
3. Basophil	About twice the size of red cells, nucleus bilobed	3% of white cells	Gives rise to macrophage, which destroys larger particle by phagocytosis.
(b) Agranulocytes	Two to three times larger than red cells, nuclear shape from round to lobed	32% of white cells	Functions in the immune response by producing anti bodies.
4. Monocyte		250,000 per mm ³	Involved in blood clotting.
5. Lymphocyte	Slightly larger than red cell, nucleus nearly fills cell		
Platelets	 Membrane bounded cytoplasmic fragment of cells in bone marrow called megakaryocytes		

Leucocytes protect the body against foreign invaders, and use circulatory system to travel to the site of invasion. Monocytes and neutrophils travel through capillaries and reach the site of wound where bacteria have gained entry. Macrophages and neutrophils feed on bacterial invaders or other foreign cells, including cancer cells (Fig. 14.21). They typically die in the process, and their dead bodies accumulate and contribute to the white substance called pus, seen at infection sites.

Basophils produce heparin - a substance that inhibits blood clotting. These also produce chemicals, such as histamine, that participate in allergic reactions and in responses to tissue damage and microbial invasion. Lymphocytes help to provide immunity against the disease.

(c) Platelets : These are not cells, but are fragments of large cells called megakaryocytes (Fig. 14.22). There is no nucleus in them. There is no pigment in them. Platelets help in conversion of fibrinogen, a soluble plasma protein, into insoluble form, fibrin. The fibrin threads enmesh red blood cells and other platelets in the area of damaged tissue, ultimately forming a blood clot. The clot serves as a temporary seal to prevent bleeding until the damaged tissue can be repaired (Fig. 14.23).

Functions of blood

The overall functions of blood in humans can be listed as follows:

- i) The plasma proteins maintain colloid osmotic pressure of the blood (75% by albumins, 25% by globulins and almost none by fibrinogen).
- ii) Blood helps to transport materials, in the body including nutrients, water, salts and waste products. All hormones are transported by blood from the endocrine tissues to the target cells.
- iii) Gases O_2 and CO_2 are transported by blood.
- iv) Blood helps in body defenses against disease, neutrophils and monocytes engulf and destroy invading microorganisms e.g. bacteria.
- v) Blood provides immunity by the lymphocytes (pages 325-327).
- vi) Blood produces interferon, and antitoxins which are proteins, and protects our body from nucleic acids and toxins of invading organism.

- vii) Blood acts as a buffer to maintain the acid - base balance i.e. concentration of H^+ and OH ions of the body.
- viii) Helps in maintaining the body temperature, concentration of water and salts, thus helps in homeostosis.
- ix) Wall of Blood helps in the exchange of materials between blood and body tissue through blood capillaries via interstitial fluid.
- x) Blood helps the body in maintaining the internal environment, by producing heparin, histamines, and also maintaining the amounts of chemicals including water and salts, in the body and maintains body temperature to a constant or nearly constant levels.
- xi) Helps in blood clotting process and seals the wounds, that stop entry of pathogens into body.

DISORDERS

There are certain disorders, related to the blood. Some of them are discussed below:

i) Leucaemia (Blood Cancer)

It is the result of uncontrolled production of white blood cells (leucocytes). This is caused by a cancerous mutation of a myelogenous or lymphogenous cell. The Leucaemia is usually characterized by greatly increased numbers of abnormal white blood cells in the circulating blood. Myelogenous cells (bone marrow cells) are in the bone marrow - and may spread throughout the body, so that white blood cells are produced in many other organs. These white blood cells are not completely differentiated, and so are defective. Leucaemia may be of different types depending on the type of white blood cells, which are undifferentiated and being produced at a faster, than normal rate. There may be neutrophilic leucaemia, eosinophilic leucaemia, basophilic leucaemia, monocytic or lymphocytic leucaemia. It is a very serious disorder and the patient needs to change the blood regularly with the normal blood, got from donors. It can be cured by bone marrow transplant - which is in most cases effective, but very expensive treatment.

ii) Thalassaemia (G. Thalassa = The sea; haema = blood)

It is also called Cooley's anaemia on the name of Thomas B. Cooley, American pediatrician. It is a

genetically transmitted haemoglobin abnormality. It is characterized by the presence of microcytes, by splenomegaly (enlargement of spleen) and by changes in the bones and skin. The blood of these patients is to be replaced regularly, with normal blood. It can be cured by bone marrow transplant - which is very expensive - and does not give 100% cure rate. Haemoglobin molecule in most cases, does not have (β - chains in it, instead F.chain is present (F is foetal haemoglobin).

iii) Oedema

It means the presence of excess fluid in the tissues of the body. The excess fluid may be in the cells, or outside the cells. The intracellular oedema is caused by osmosis of water into the cells, and cause, depression of metabolic systems (due to lack of nutrition and O_2 in the tissues) especially and the Na-pump.

The extracellular oedema may be the result of :

- i) Abnormal leakage of fluid from the blood capillaries or failure of the lymphatic system to return fluid from the interstitial fluid.
- ii) Oedma is caused by renal retention of salts and water. Oedema disturbs the exchange and concentration of minerals and ions in the blood and body cells, affects blood pressure, increases heart load etc.

(B) Pumping Organ - The Heart

Structure and action : The heart of humans is located in the chest cavity. The heart is enclosed in a double membranous sac - the pericardial cavity, which contains the pericardial fluid. Pericardium protects the heart, prevents it from over extension.

The wall of the heart is composed of three layers.

- (i) **Epicardium** (ii) **Myocardium** (iii) **Endocardium**

Myocardium of the heart is made up of special type of muscles, the cardiac muscles.

These muscles contain myofibrils, and myofilaments of myosin and actin. Their arrangement is similar to those in skeletal muscle fibres, and their mechanism of contraction is essentially the same, except that they are branched cells, in which the successive cells are separated by junctions called intercalated discs. The heart contracts automatically with rhythmicity, under the control of the autonomic nervous system of the body.

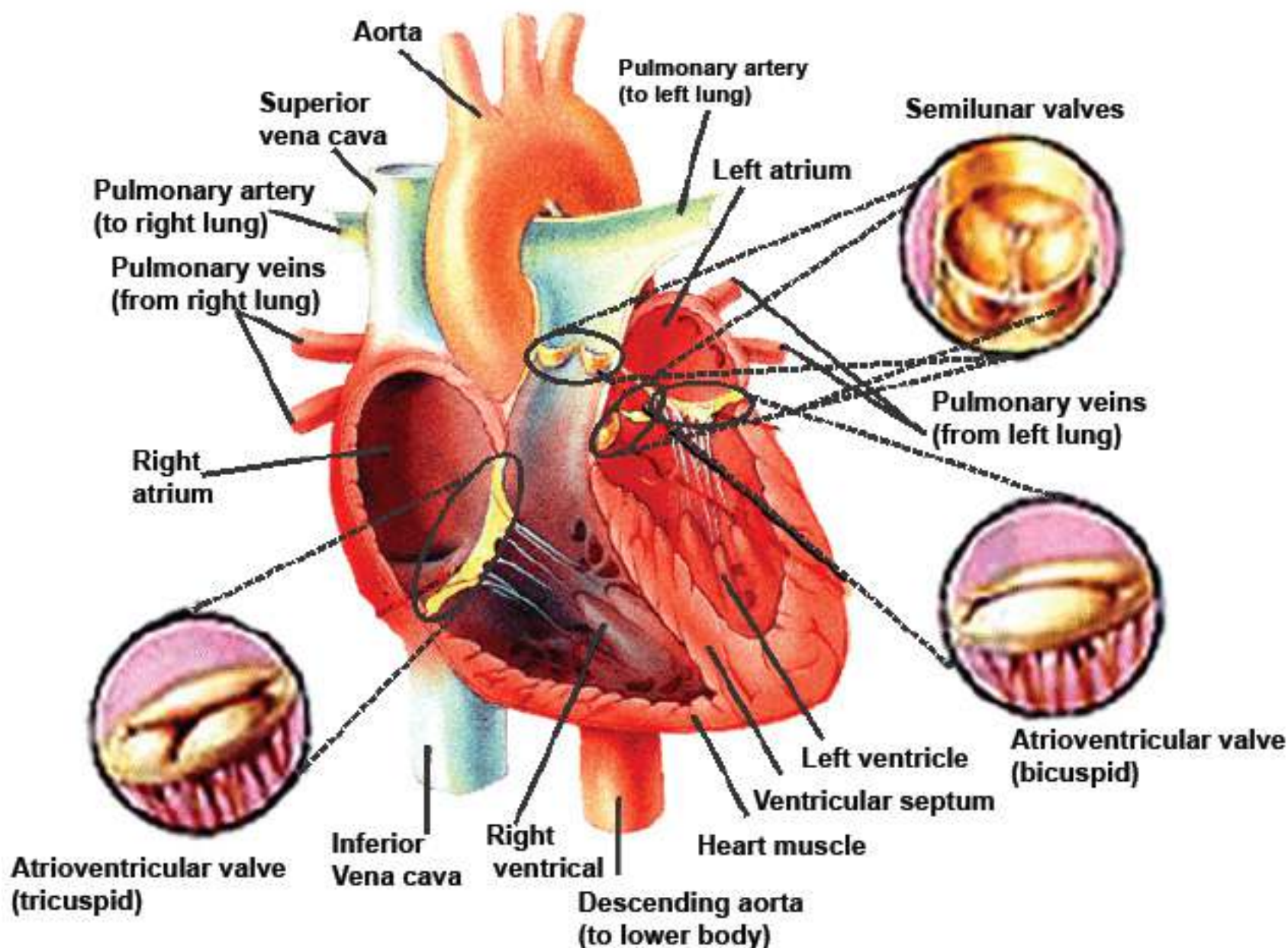

Fig 14.24 The human heart and its valves and vessels.

There are four chambers of the heart: two upper thin-walled atria, and two lower thick walled ventricles. Human heart functions as a double pump, and is responsible for pulmonary and systemic circulation. Complete separation of deoxygenated blood (Right side) and oxygenated blood (left side), in the heart, is maintained. The right atrium receives deoxygenated blood via venae cavae from the body.

The blood is passed on to right ventricle through tricuspid valve (called so because it has 3 flaps). These flaps are attached with fibrous cords called chordae tendinae, to the papillary muscles which are extensions of the wall of the right ventricle. When right ventricle contracts, the blood is

passed to pulmonary trunk, which carries blood via left and right pulmonary arteries, to the lungs. At the base of the pulmonary trunk, semilunar valves are present. After oxygenation in lungs the blood is brought by pulmonary veins to the left atrium, which passes this blood via bicuspid valve (called so because it has two flaps) to the left ventricle. The flaps of bicuspid valve are similarly attached through chordae tendinae, to papillary muscles of the wall of left ventricle. When the left ventricle contracts, it pushes the blood through aorta to all parts of the body (except lungs). At the base of aorta semilunar valves are also present. The valves of the heart control the direction of flow of blood. The wall of left ventricle is thicker (about 3 times) than that of the right ventricle. At the base of aorta, first pair of arteries, the coronary arteries, arise, and supply blood to the heart. The aorta forms an arch, and before descending down gives three branches supplying blood to head, arms and shoulders. The aorta descends down in the chest cavity. It gives many small branches to the chest wall and then passes down to the abdominal region. Here it gives branches, which supply blood to different parts of alimentary canal, kidneys and the lower abdomen.

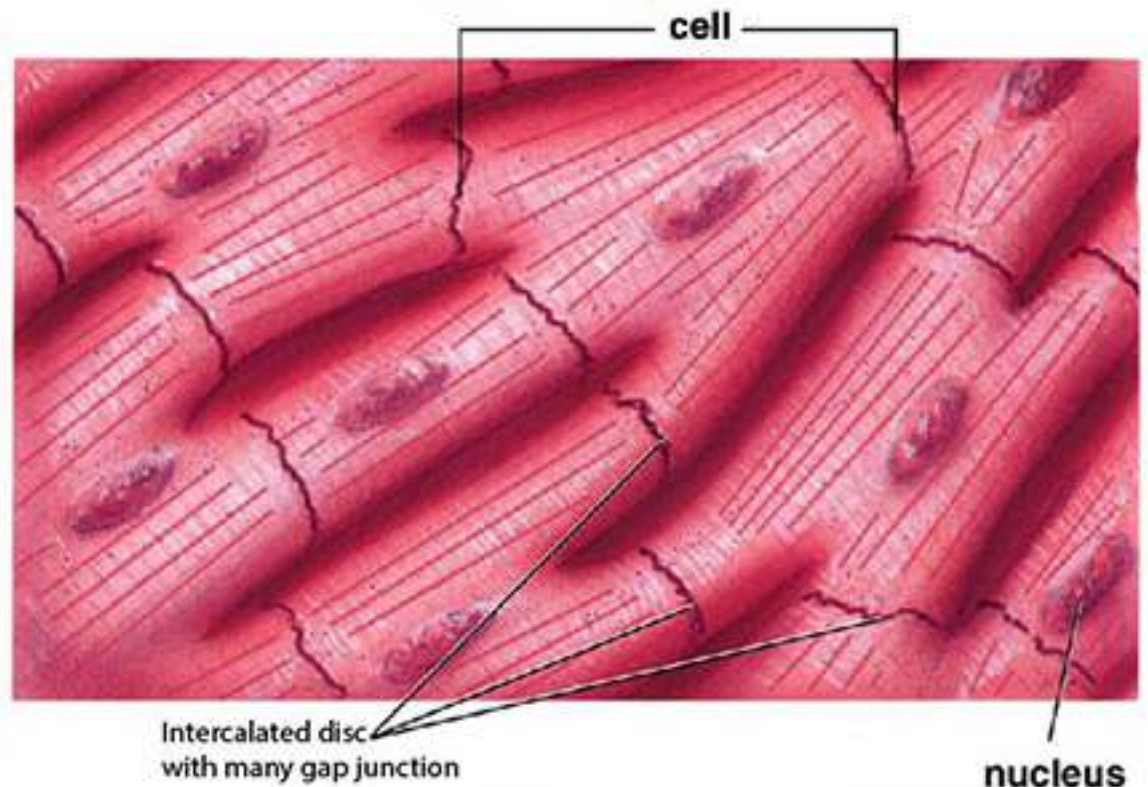

Fig.14.25 The structure of cardiac muscle

The aorta bifurcates into iliac arteries, each of which leads to supply blood to each leg. The blood from the upper part of the body is collected by different veins, which join to form superior vena cava; which passes its blood to the right atrium. Two **iliac veins** are formed by veins which collect blood from legs, and unite to form inferior **vena cava**. It receives **renal vein** from each kidney; and **hepatic vein** from the liver, before it enters the right atrium. The liver receives **hepatic portal vein** which is formed by many veins collecting deoxygenated blood with absorbed food from different parts of alimentary canal.

The Cardiac Cycle

It is the sequence of events which take place during the completion of one heart beat. Heart beat involves three distinct stages (Fig. 14.26).

1. Relaxation phase - diastole.

The deoxygenated blood enters right atrium through vena cava, and oxygenated blood enters left atrium through pulmonary veins. The walls of the atria and that of ventricles are relaxed. As the atria are filled with blood, they become distended and have more pressure than the ventricles. This relaxed period of heart chambers is called diastole.

2. Atria Contract - atrial systole

The muscles of atria simultaneously contract, when the atria are filled and distended with blood, this is called atrial systole. The blood passes through tricuspid and bicuspid valves, into the two ventricles which are relaxed.

3. Ventricles contract - ventricular systole

When the ventricles receive blood from atria, both ventricles contract simultaneously and the blood is pumped to pulmonary arteries and aorta. The tricuspid and bicuspid valves close, and 'lubb' sound is made. Ventricular systole ends, and ventricles relax at the same time semilunar valves at the base of pulmonary artery and aorta close simultaneously, and 'dubb' sound is made. (Lubb, dubb can be heard with the help of a stethoscope).

One complete heart beat consists of one systole and one diastole, and lasts for about 0.8 seconds. In one's life, heart contracts about 2.5 billion times, without stopping.

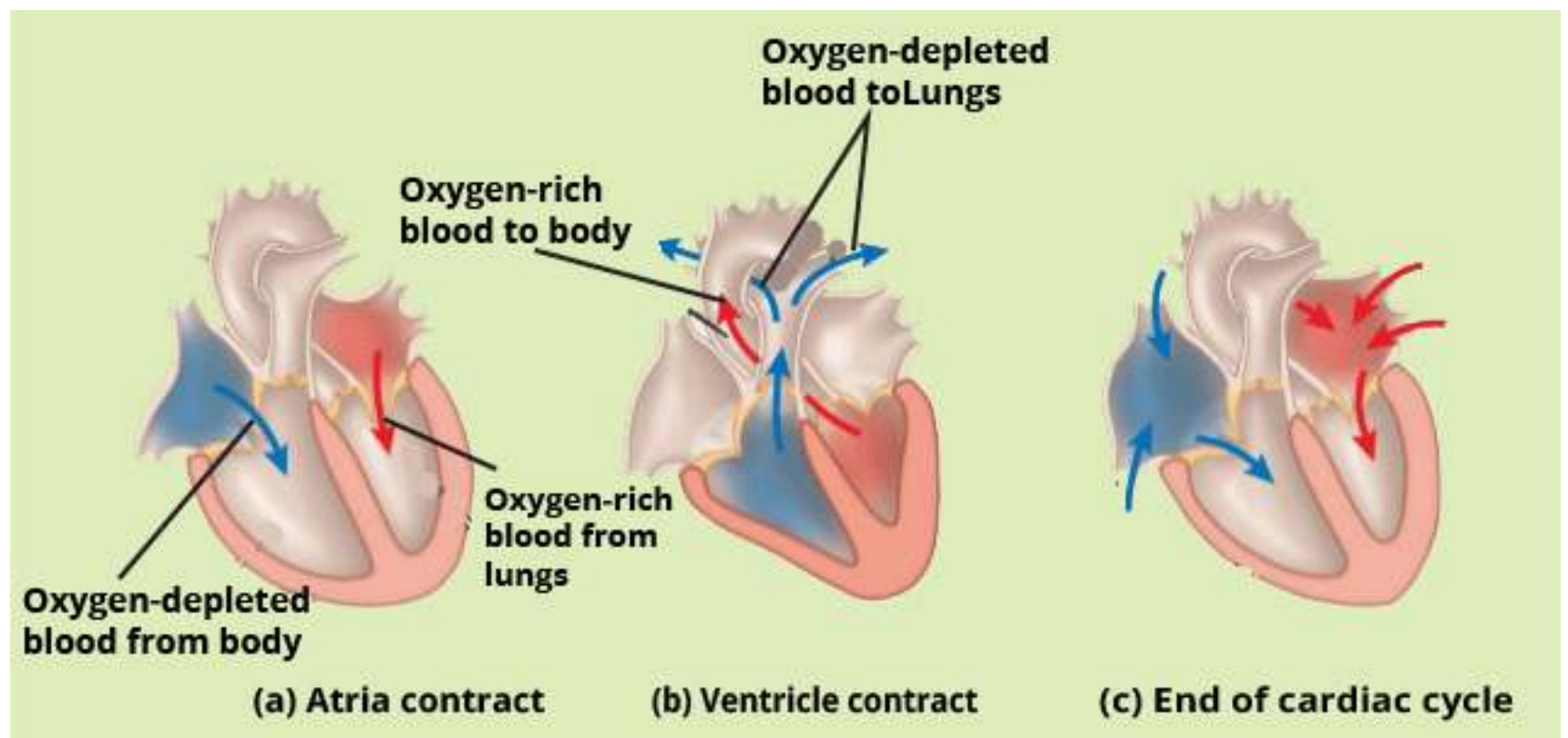

Fig.14.26 The cardiac cycle

Mechanism of heart Excitation and Contraction

The heart beat cycle described above starts when the sino-atrial node (Pace maker) at the upper end of right atrium sends out electrical impulses to the atrial muscles, and causing both atria to contract. The sino-atrial node consists of a small number of diffusely oriented cardiac fibres, possessing few myofibrils; and few nerve endings from the autonomic nervous system.

Impulses from the node travel to the musculature of the atrium and to an atrioventricular node. From it an atrioventricular bundle of muscle fibres propagates the regulatory impulses via excitable fibres in interventricular septum, to the myocardium of the ventricles. There is a delay of approximately 0.15 second in conductance from the S-A node to A-V node, permitting atrial systole to be completed before ventricular systole begins (Fig. 14.28).

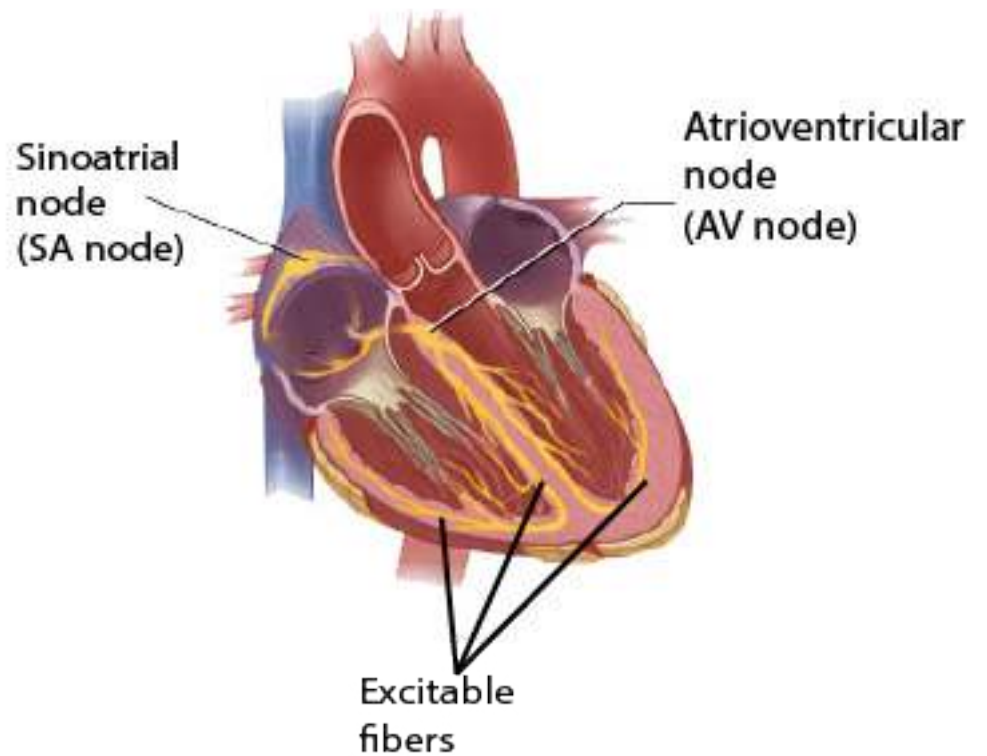
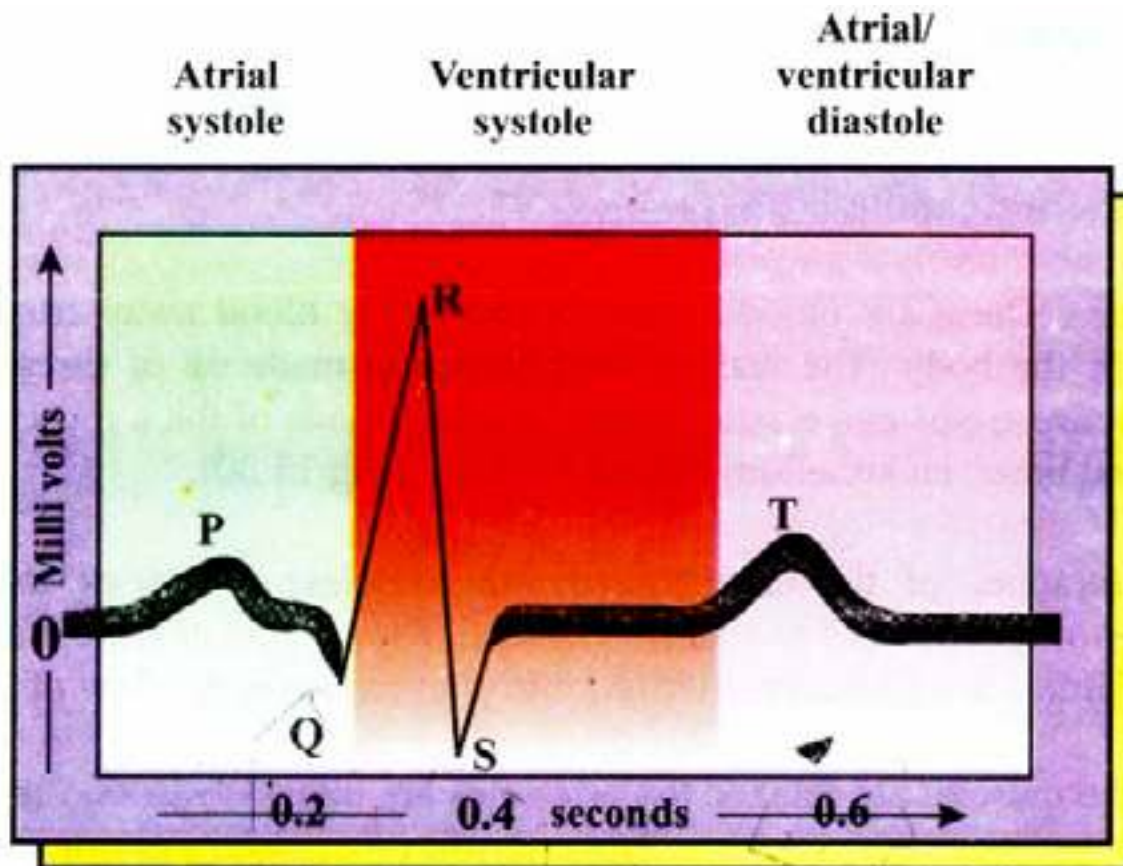

Fig.14.27 The heart's pacemaker and its connections

*Animation 14.13: Heart pacemaker
Source & Credit: thevisualmd*

Electrocardiogram

As the cardiac impulse passes through the heart, electrical currents spread into the tissues surrounding the heart, and a small proportion of these spread all the way on the surface of the



A normal electrocardiogram (ECG) indicates that the heart is functioning properly. The P wave occurs just prior to atrial contraction; the QRS wave occurs just prior to ventricular contraction and the T wave occurs when the ventricles are recovering from contraction.

body. If electrodes are placed on the skin on opposite sides of the heart, electrical potentials generated by these currents can be recorded. This recording is known as electro cardiogram which is taken by electrocardiograph (E.C.G.) machine. It helps to diagnose the abnormalities in the rhythmicity and conduction system of the heart which may be corrected by the use of artificial pacemaker.

Artificial pace maker

Pacemaker is responsible for initiating the impulses which trigger the heart beat rate. If there is some block in the flow of the electrical impulses, or if the impulses initiated by S.A. node are weak; it may lead to death of the individual. So an artificial pacemaker, which is battery operated producing electrical stimulus is used. For example if A-V pathway is blocked, the electrodes of artificial pacemaker are attached to the ventricle. Then this pacemaker provides continued rhythmic impulses that take over the control of the ventricles.

Blue babies

Failure of interatrial foramen (an opening in the inter-atrial septum) to close or of ductus arteriosus to fully constrict results in cyanosis (blueness of skin) of new born. This is due to mixing of blood between two atria and the mixed blood is supplied to the body of newborn babies resulting in blueness of skin, thus the name blue babies.

(C) Blood vessels

The third component of the blood circulatory system of humans comprises of the blood vessels; arteries, capillaries and veins.

(i) Arteries : These are blood vessels which carry blood away from the heart to different parts of the body. The wall of the arteries is made up of three layers, outer, (made of connective tissue and elastic fibres), middle (made of thick muscular tissue and elastic fibres) and inner, endothelium (Table 14-3, and Fig 14.30).

The contraction of the circular (smooth muscles) of arteries and arterioles is under the control of nervous and endocrine systems. When stimulated the muscle contracts, constricting the arterioles (vasoconstriction) and thus reducing the flow of blood in them.

When the muscles are relaxed the arterioles are dilated (vasodilation) more blood flows in them, The arterioles themselves divide repeatedly until they form a dense network of microscopic vessels, called capillaries.

Atherosclerosis (G. ather = porridge; skeleoris = hardening): It is coexisting atheroma and arteriosclerosis; atheroma is deposition of hard yellow plaque of lipid material in the inner most layer of the arteries, which may be due to high level of cholesterol in the blood. Arteriosclerosis is a degenerative arterial change associated with advancing age. Primarily a thickening of middle layer of arteries, and usually associated with some degree of atheroma. So Atherosclerosis causes narrowing and hardening of arteries. This increases the risk of formation of thrombus (see thrombus formation), and if thrombus is formed in the brain or heart it is fatal. (Atherosclerosis is a major condition leading to heart attack.

(ii) Capillaries : These are blood vessels with walls that are only one cell thick (Table 4.3, Fig. 14.29, 14.30). Although the blood appears confined within the capillary walls, the latter are permeable with the result, that water and dissolved substances pass in and out exchanging oxygen, carbon dioxide dissolved food and excretory products with the tissues around capillary. The capillary network is

so dense that no living cell is far from a supply of oxygen and food. In the liver, every cell is in direct contact with a capillary. The diameter of a capillary can be altered by nervous stimulation, which tends to close them, and by chemicals, such as histamine, which dilate them. The change in diameter is brought about by a change in the shape of the cells, constituting their walls. The pre capillary sphincters also regulate the amount of blood flowing in capillaries. Thus the amount of blood flowing in a certain tissue is controlled.

The capillaries are the sites where the materials are exchanged between the blood and body tissues. This exchange occurs in three ways.

- (i) Active transport and diffusion through the cells lining the capillary wall into the interstitial or extracellular fluid, and then to the body cells, and vice versa.
- (ii) Through the intercellular spaces of endothelial lining of wall of capillary to and from the extracellular fluid.
- (iii) Materials from the cavity of capillaries are also taken up by endocytosis, and then passed to the other side by exocytosis. Same is true for some materials entering from the intercellular spaces (extracellular fluid) into the blood.

Thus the exchange of materials takes place between blood and tissues via extracellular or interstitial fluid. Capillaries join to form venules, which join to form veins.

(iii) Veins : These blood vessels transport blood from body cells towards heart. The wall of veins has same three layers as are present in arteries. But middle layer is relatively thin and only slightly muscular, with few elastic fibres, (table 14.3 and Fig. 14.30). The semilunar valves are present in the veins. These valves prevent the back flow of blood, as it is moving towards the heart. The pressure of surrounding muscles, when they contract, tends to squash the veins and assist the return of blood towards heart.

Veins join to form larger veins, and ultimately form venae cavae (Inferior vena cava and superior vena cava) which pour the blood into the right atrium of the heart. The oxygenated blood from the lungs is brought to the left atrium by pulmonary veins.

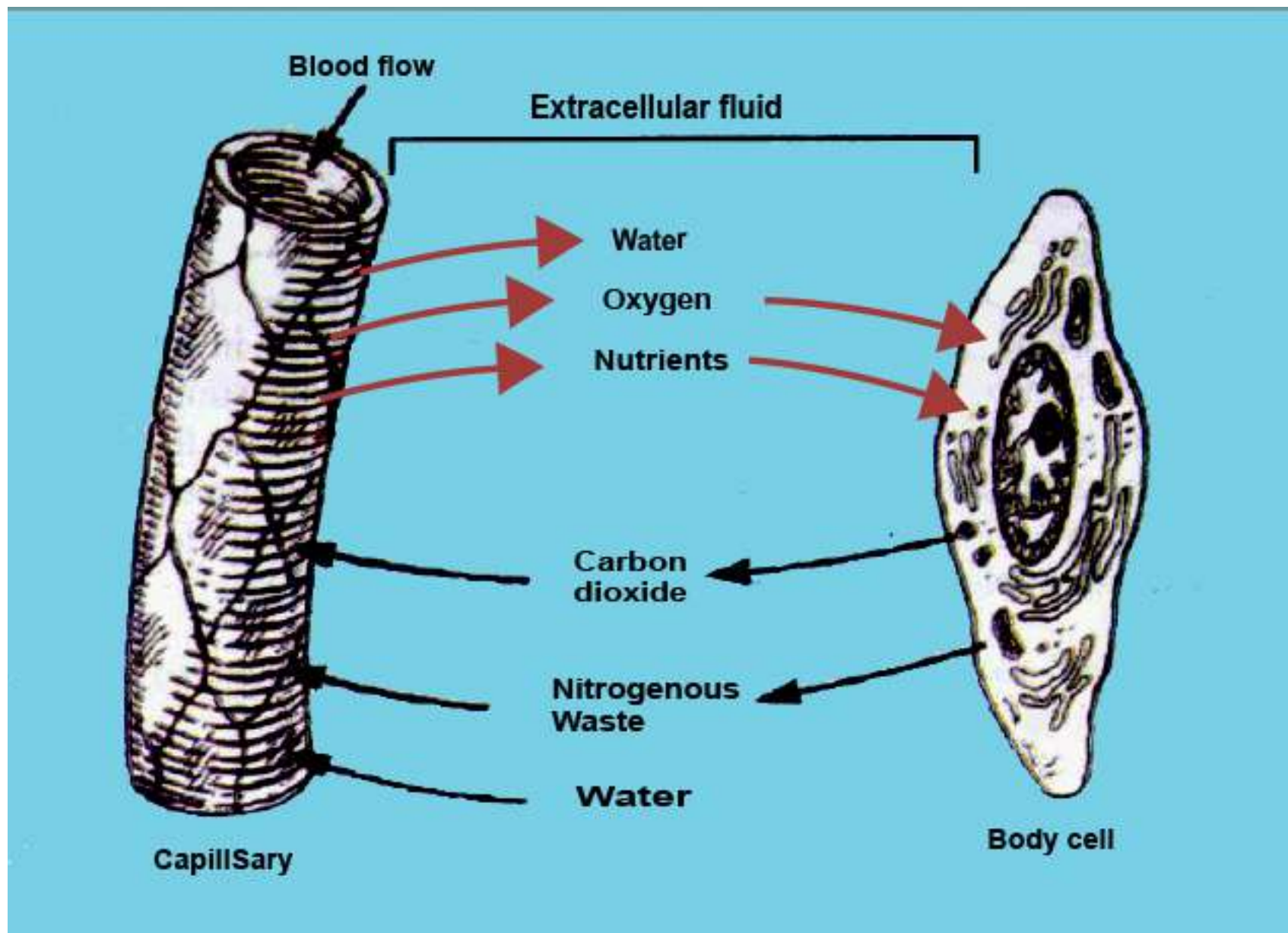

Fig.14.29 The exchange of gases and nutrients in a capillary.

The pressure within capillaries causes a continuous leakage of fluid from the blood plasma into the spaces that surround the capillaries and tissues. This fluid, known as interstitial fluid consists primarily of water, in which the dissolved nutrients, hormones gases, wastes, and small proteins from the blood are present. Large proteins red blood cells and platelets cannot cross the intercellular spaces of capillary wall, so they remain within capillaries. But some white blood cells can squeeze out through the intercellular spaces of capillary wall. Interstitial fluid is the medium through which the exchange of materials between the blood and nearby cell occurs. (Fig. 14.29)

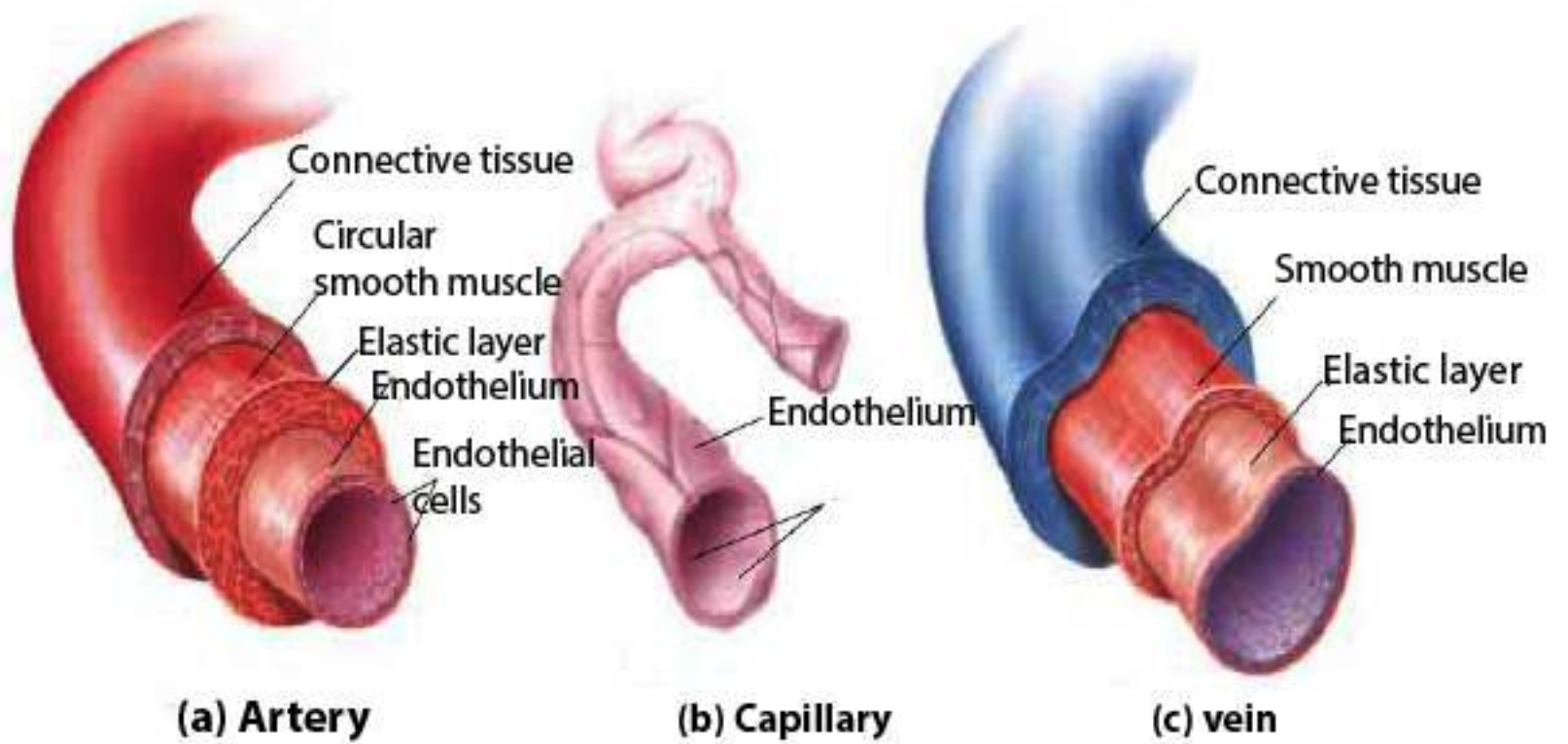

Fig.14.30 Showing the comparison in structure of artery, capillary and vein.

Animation 14.14: Structure of artery
Source & Credit: my-ecoach

Table 14.3 Comparison in structure and function of an artery, capillary and vein

Arteries	Veins	Capillaries
1. These transport blood away from the heart to the various parts of the body through capillaries.	1. These collect blood from body through capillaries and transport it towards heart.	1. These link arteries with veins.
2. All arteries carry oxygenated blood except pulmonary arteries.	2. All veins carry deoxygenated blood except pulmonary veins.	2. These have mixed oxygenated and deoxygenated blood.
3. There are no valves in them except at the base of pulmonary trunk and aorta.	3. Valves are present. These prevent the back flow of blood.	3. There are no valves.
4. Have high blood pressure.	4. Have low blood pressure.	4. Falling pressure in these.
5. Wave of blood pressure or pulse due to heartbeat can be detected.	5. No pulse.	5. No pulse.
6. Blood flow rapid. 400-500mm per second in aorta and decreasing in arteries and arterioles.	6. Rate of blood flow increases from smaller to larger veins.	6. Blood flow slowest less than 1 mm per second.
7. Have smaller bore and thick wall.	7. Have larger bore and thin walls.	7. Larger bore; wall one cell in thickness.
8. Thick muscle layer and elastic fibres present. The elasticity helps changing the pulsating flow of blood.	8. Thin muscle layer and less elastic fibres. So they are less elastic.	8. No muscles or elastic fibres.
9. No exchange of materials.	9. No exchange of materials.	9. Responsible for exchange of materials.

Blood Pressure and Rate of flow of Blood

It is the measure of force with which blood pushes up against the walls of blood vessels. It is the force that keeps blood flowing from the heart to all the capillary networks in the body. This pressure is generated by the contraction of ventricles (ventricle systole) and is the highest in aorta, then gradually reduces in arteries. The walls of arteries are elastic and the flow of blood stretches them, and it is felt as pulse. During diastole, the relaxation phase of the cardiac cycle, the heart is not exerting pressure on the blood in the arteries and pressure in them falls. The pressure reaches

its high point during systole (systolic pressure which in normal individuals is 120 mm Hg) and its low point during diastole (diastolic pressure which in normal individuals ranges between 75-85 mm Hg). The blood pressure gradually declines (Fig. 14.31). The decline of the blood pressure in successive parts of systemic circuit, is the result of friction between the flowing blood and the walls of the blood vessels - thus blood moves from a region of higher pressure towards a region of lower pressure.

Several other changes occur along the route of blood flow.

i) The difference between systolic and diastolic pressure continues to diminish until it disappears in the capillaries and veins.

ii) The rate of blood flow tends to fall as the blood moves through the branching arteries and arterioles, the rate is lowest in the capillaries; and increases again in the venules and veins. These changes in rate of blood flow result from changes in the total cross sectional area of the vessel system. The flow of blood in veins is maintained by the contraction of surrounding muscles and the action of semilunar valves which prevent back flow of blood. Muscular activity including breathing movements help normal flow of blood in the body.

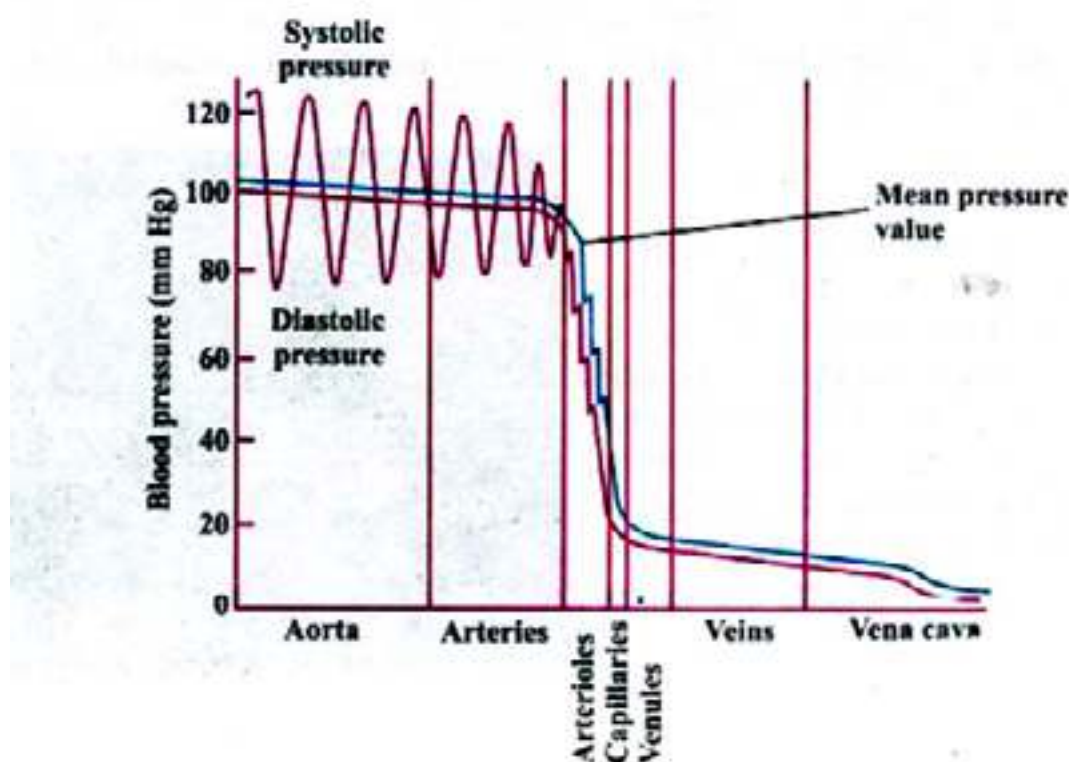

Fig.14.31(a) graph of blood pressure in different parts of the human circulatory system.

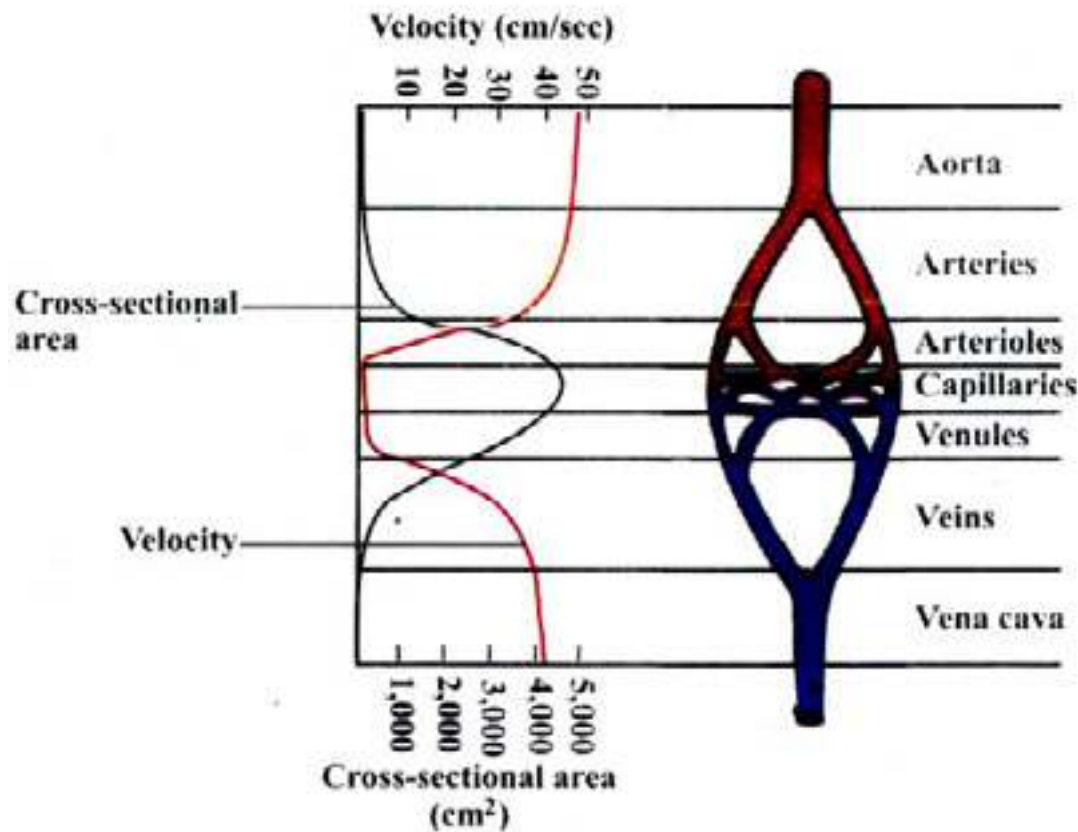

Fig.14.31 (b) Change in the velocity of blood flow in the various parts of a systemic circulatory pathway.

Hypertension

It is a condition of high blood pressure. Prolonged high blood pressure damages the lining of the blood vessels and also leads to weakening of heart muscles (which have become thickened due to the continuous strain imposed on them), with declining efficiency of the pumping action of the heart. Blood may then be retained in the heart and lungs, often leading to fatal condition called congestive heart failure.

Thrombus Formation and Hypertension

Thrombus is a solid mass or plug of blood constituents (clot) in a blood vessel. This mass may block (wholly or only in part) the vessels in which it forms, or it may be dislodged and carried to some other location in the circulatory system, in which case it is called an embolus. Thrombosis is the formation of thrombus (Fig. 14.32). Thromboembolism is leading cause of deaths in western civilization.

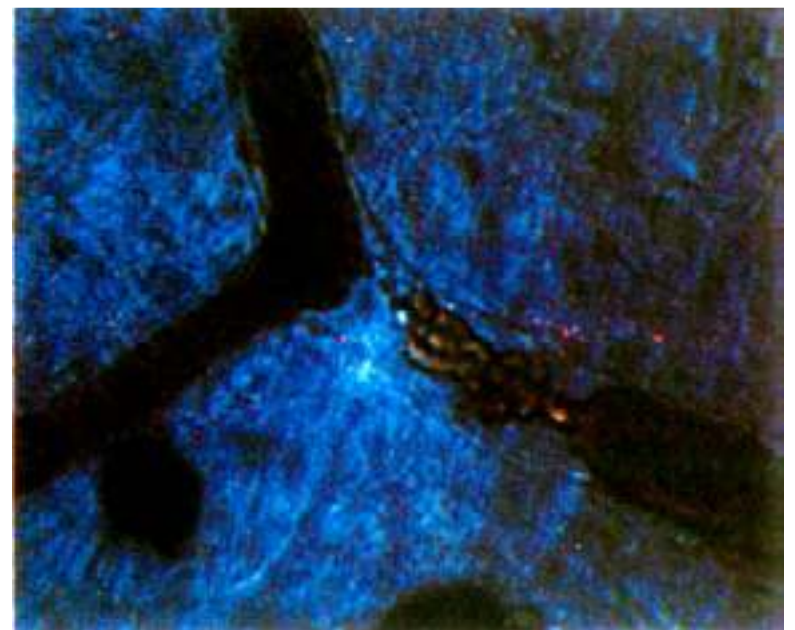

14.32 A thrombus in a small blood vessel. The thrombus (tangled red mass) has blocked blood flow near a point where the vessel branches. The blood has pulled away from the left end of the thrombus and is beginning to pull away from the right end also.

Thrombus formation may be due the following:

- i) Irritation or infection of lining of blood vessels.
- ii) Reduced rate of blood flow, due to long periods of inactivity.
- iii) Pneumonia and tuberculosis, emphysema

Heart attack (Myocardial infarction)

Blockage of blood vessel in the heart by an embolus (or by locally formed thrombus) causes necrosis or damage to portion of heart muscles, a condition known as a heart attack or technically myocardial infarction, Heart attack is due to disruptions of control system of the heart with accompanying arrhythmias, especially ventricular fibrillation.

We can avoid the above mentioned situations if we :

- i) Avoid too much fatty food (especially rich in cholesterol). Maintain normal body weight.
- ii) Control blood pressure by regular walk and exercise.
- iii) Do not smoke.

Stroke

If the normal flow of blood is blocked by an embolus (or a locally formed thrombus), in a blood vessel in the brain, and causes necrosis, or death, of the surrounding neural tissue (owing to lack of O_2), the condition is called a stroke or cerebral infarction. The symptoms of the stroke vary depending on the part of the brain that has been damaged.

Haemorrhage

It is the discharge of blood from blood vessels. Especially important is the brain haemorrhage which results from bursting of any of the arteries supplying the brain. When the wall of the arteries becomes hard and loses its elasticity - and higher blood pressures would result in brain haemorrhage. To avoid brain haemorrhage, the blood pressure must be controlled between normal limits.

In almost all the above mentioned problems, it is important to take following preventive measures :

- Taking in of less cholesterol in our food. Maintenance of normal blood pressure.
- Do not become over weight.
- Do not smoke.
- Do regular exercise.
- Avoid stress and tension.

LYMPHATIC SYSTEM

This system is responsible for the transport and returning of materials from the tissues of the body to the blood.

The system comprises lymph capillaries, lymph vessels, lymphoid masses, lymph nodes, and **lymph**-the fluid which flows in the system.

Lymph capillaries end blindly in the body tissues, where pressure from the accumulation of interstitial fluid or extracellular fluid forces the fluid into the lymph capillaries. When this fluid enters the lymph capillaries, it is called lymph. The lymph vessels empty in veins; so lymph is a fluid in transit between interstitial fluid and the blood.

The intercellular spaces in the walls of lymph vessels are larger than those of the capillaries of blood vascular system. So larger molecules, from the interstitial fluid can also enter the lymph capillaries.

Lymph capillaries join to form larger and larger lymph vessels; and ultimately form thoracic lymph duct, which opens into subclavian vein. The flow of lymph is always towards the thoracic duct.

In the intestine, the branches of lymph capillaries, within villi, are called lacteals.

The flow of lymph is maintained by :

Activity of skeletal muscles, movement of viscera, breathing movements and the valves, which prevent back flow of lymph.

Along the pathway, the lymph vessels have, at certain points, masses of connective tissue where lymphocytes are present; these are **lymph nodes**. Several afferent lymph vessels enter a lymph node, which is drained by a single, efferent lymph vessels.

Lymph nodes are present in the neck region, axilla and groin of humans.

In addition, several lymphoid masses are present in the walls of digestive tract, in the mucosa and submucosa. The larger masses spleen and thymus, tonsils and adenoids are all lymphoid masses. These produce lymphocytes.

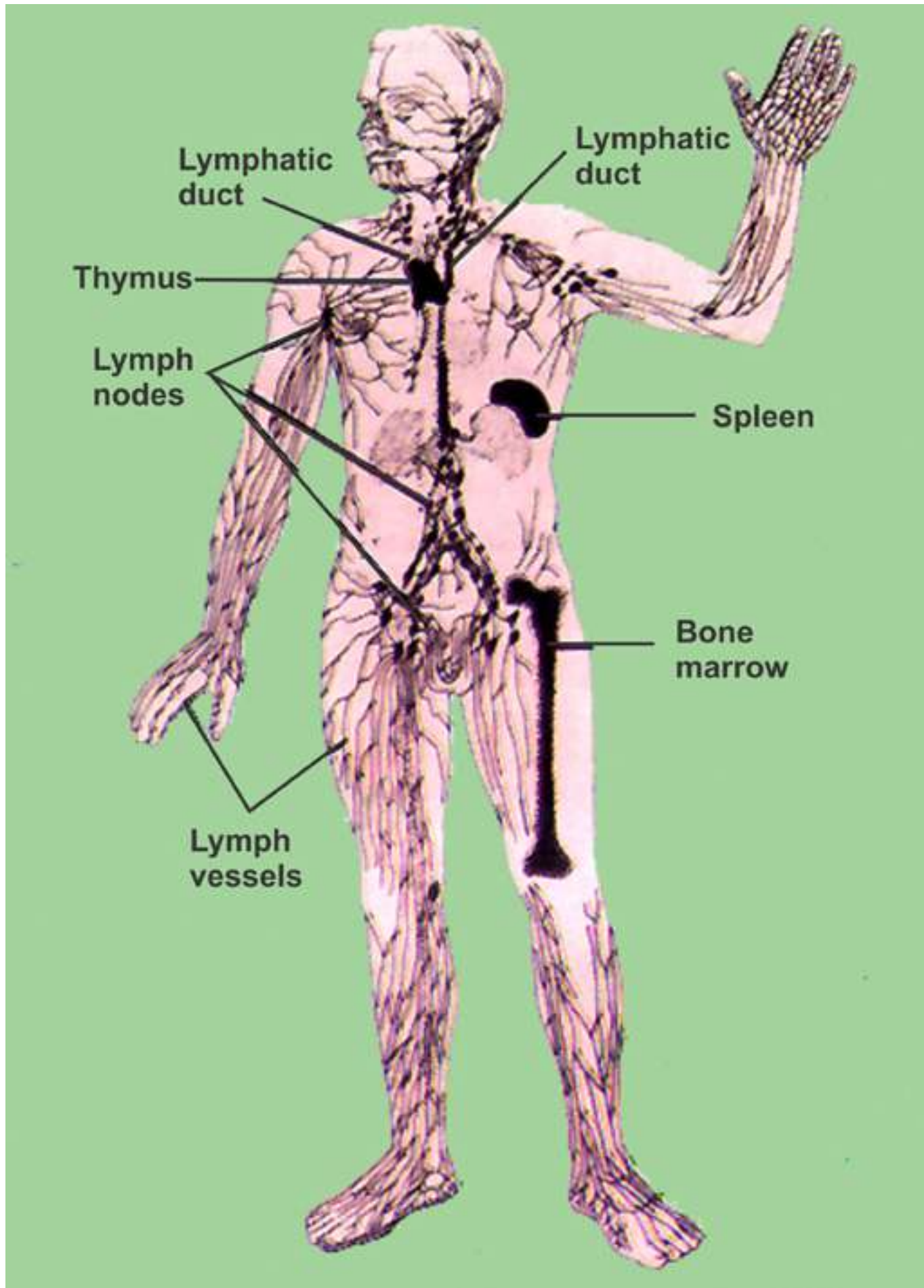

Fig. 14.33 Human lymphatic system.

There are the several functions performed by lymphatic system.

- i) In an average person, about three litres more fluid leaves the blood capillaries than is reabsorbed by them each day. It returns this excess fluid and its dissolved proteins and other substances to the blood.
- ii) The lacteals of villi absorb large fat globules, which are released by interstitial cells after the products of digestion of fats are absorbed. After a fatty meal these fat globules may make up 1% of the lymph.
- iii) The lymphatic system helps defend the body against foreign invaders. Lymph nodes have lymphocytes and macrophages that destroy bacteria and viruses. The painful swelling of lymph nodes in certain diseases (mumps is an extreme example) is largely a result of the accumulation of dead lymphocytes and macrophages.
- iv) Just as the lymph nodes filter lymph, the spleen filters blood, exposing it to macrophages and lymphocytes that destroy foreign particles and aged red blood cells.

IMMUNITY - AND ITS TYPES

Immunity

The capacity to recognize the intrusion of any material foreign to the body and to mobilize cells and cell products to help remove the particular sort of foreign material with greater speed and effectiveness" is called **immunity**.

In animals in addition to physical barriers (skin + mucous membranes) and phagocytes, there is a third mechanism, to defend their bodies against the foreign invaders; this is the **immune system**.

The components of immune system include the lymphocytes (B and T) and the antibodies - which are special type of proteins. These antibodies are immunoglobulins which are synthesized by vertebrates, in response to antigens; and immobilise it, or sets in motion events that ultimately cause its destruction.

Lymphocyte T and B have been named due to their relationship with Thymus gland, and Bursa of Fabricius respectively. The influence of the thymus gland essential in making T-cells immunologically competent. Bursa of Fabricius is lymphoid structure present in the wall of cloaca of young birds from where B-lymphocytes were discovered to have role in immune system.

Antigen or immunogen is a foreign substance, often a protein which stimulates the formation of antibodies (Fig. 14.34) **Antibodies** are specific i.e. cause the destruction of the antigen, which stimulated their production. **Antibodies** are manufactured in B-lymphocytes, then secreted into the lymph and blood where they circulate freely.

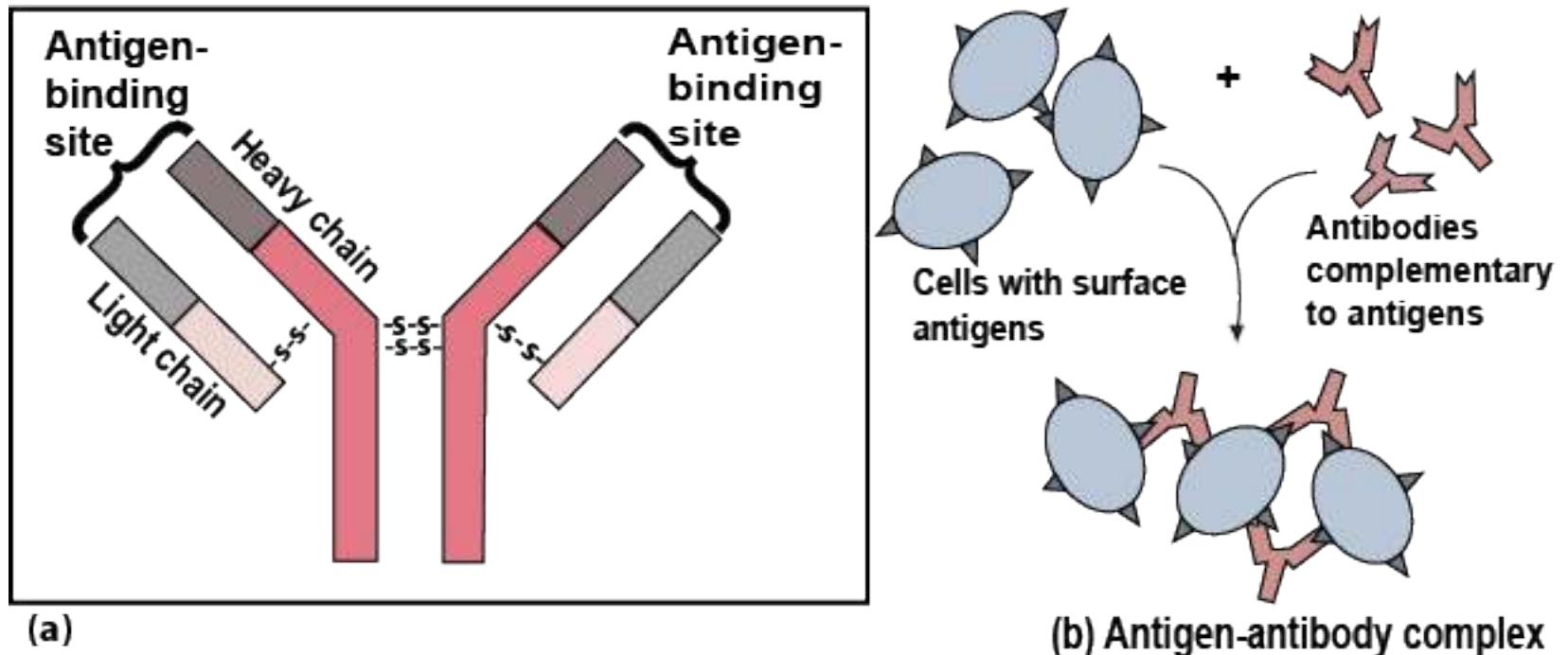

Fig. 14.34 (a) An antibody molecule consists of four polypeptide chains - two identical light chain and two identical heavy chains - linked by disulfide (-S-S-) bridges. Variable amino acid sequences (V) in the light chains and upper regions of the heavy chains determine which antigen will bind to that particular antibody. Constant amino acid sequences (C) are the same for all the antibodies in one class (b) Large antigen-antibody complexes will form if there are multiple copies of the antigenic molecule on the foreign cell's surface.

T-cells recognize antigen, then combat micro-organisms and / or effect the rejection of foreign tissues (in case of tissue transplant). This is called **cell-mediated response**.

B-cells recognize antigen and form plasma cell clone. These plasma cells synthesise and liberate antibodies into the blood plasma and tissue fluid. Here antibodies attach to the surfaces of bacteria and speed up their phagocytosis, or combine with and neutralise toxins produced by micro-organisms, by producing antitoxins. This is called **humoral Immune response**.

When we get vaccination, against a specific disease (antigen), we become immune to that infection or disease. If we get vaccination against, polio, smallpox, measles, mumps etc., once in our life time, we are protected or become immune to that infection in our future life.

Types of immunity

Active Immunity : The use of vaccines, which stimulate the production of antibodies in the body, and making a person immune against the disease or infection, is called **active immunity**. But this active immunity has been achieved by artificially introducing, antigens in the body, so it is called **artificially induced active immunity**.

But, when a person is exposed to an infection (antigen) - becomes ill, and in most cases survives then this immunity, developed against that disease is called **naturally induced immunity or auto immune response**.

Antiserum is a serum containing antibodies.

Passive immunity : In contrast to active immunity, in which case antigens are introduced to stimulate the production of antibodies, by artificial or natural method; antibodies are injected in the form of antisera, to make a person immune against a disease, This is called **passive immunity**.

In body, antigen - antibody complexes are formed which are taken up by phagocytes and destroyed. The patient is spared the complications (or possibly death) caused by the infection or venom.

Passive immunity response is immediate, but not long lasting. Because no time is taken for the production of sufficient level of antibodies, (as antibodies are being injected) and after the level of antibodies is reduced or they are used up - No more antibodies production is there.

The method of passive immunization is used to combat active infections of, tetanus, infectious hepatitis, rabies, snake bite venom etc. In the case of snake bite venom passive immunity is produced by the antitoxins so the serum is called antivenom serum.

AIDS (*Acquired Immune Deficiency Syndrome*); is a disease caused by a virus. The affected persons suffer from deficiency in their immun system of the body, and the immune system collapses. Thus the **AIDS** victim often succumb to a bacterial disease or cancer, that under normal circumstances, the immune system can over come. There is no known cure of the disease. It can spread by blood transfusion and by sexual contact with the infected persons.

EXERCISE

Q.1 Fill in the blanks :

- (i) In the process of facilitated diffusion, the carrier molecules are.....
- (ii) Pure water has a water potential which is equal to
- (iii) The insects which feed on the phloem of plants are the
- (iv) The substance produced by basophils which inhibits blood-clotting is
- (v) The most abundant compound of blood plasma of man is
- (vi) in 1874 suggested that water molecules move along the cells walls of xylem vessels due to imbibition.

Q.2. Write whether the statement is 'true' or 'false' and write the correct statement if it is false.

- (i) The intercellular openings in the blood capillaries are larger than the openings in the lymph capillaries.
- (ii) Between the left auricle and the left ventricle in human heart, the valve present is called tricuspid valve.
- (iii) The pacemaker of the heart of man is the AV node.
- (iv) Each sieve tube member is associated with one or more tracheid cells.
- (v) The method of active immunization is used to combat active infections of tetanus and rabies.

Q.3. Extensive Questions

- (i) How are minerals and water taken up by roots? Draw the structures involved and the pathways for water and minerals from soil water to xylem, and the transport processes at each step.
- (ii) Describe the mechanism of opening and closing of stomata.
- (iii) How does the pressure-flow theory explain the movement of sugars through a plant?
- (iv) Describe cohesion-tension theory of water movement in xylem. What supplies the cohesion, and what is the source of tension? How do these two forces interact to move water through plant,
- (v) Explain, apoplast, symplast and vacuolar pathways, and describe the movement of water and dissolved minerals, through them.
- (vi) Explain water potential. What is the relationship of water potential with solute potential and pressure potential?
- (vii) Name and describe the general functions of the three major type of cells or cell like bodies found in blood of humans. Which of these cell types is found predominantly in lymph?
- (ix) Write a note on immunity and its types.